

12-inch car holder instruction

VUM20U /VHM22H/VHM22K User manual

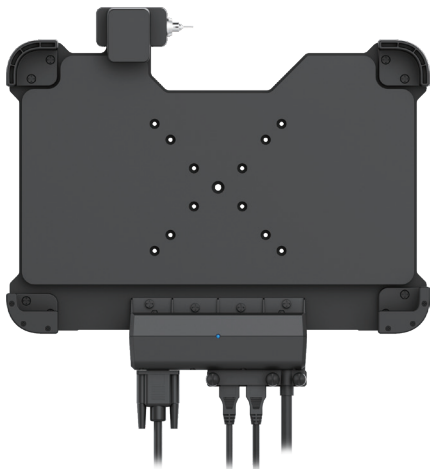

Contents

I . Product Introduction	
1. Appearance description	
2. Indicator light description	
II. Instruction for use	
1. Installation	
2. Charging	
3. Expansion interface	
4. Accessories and use	
III. Accessories and use	

I . Product Introduction

1. Appearance description

Front view:

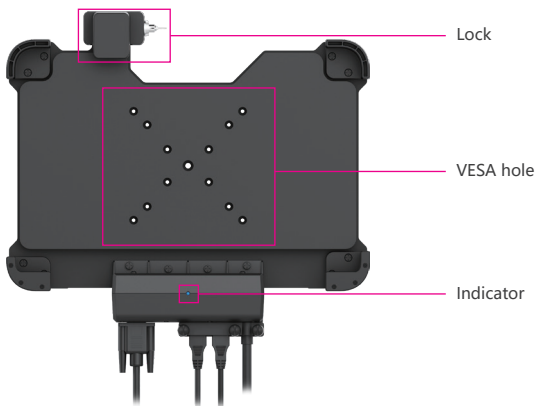

Top view:

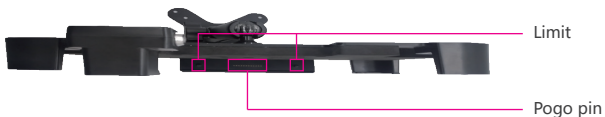

Bottom view:

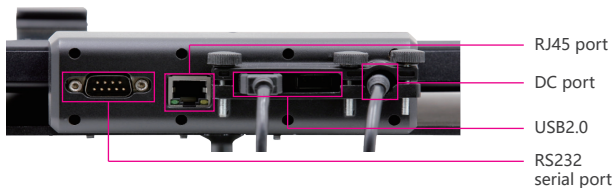

2. Indicator light description

Green power indicator. Place the tablet correctly, connect to the DC power, and the indicator light will light up.

II. Instruction for use

1. Installation

1.1 Unlock with the key and pull up the buckle.

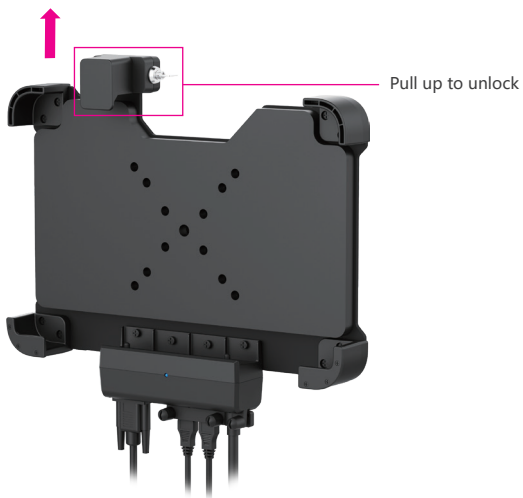

1.2 Place the tablet, pull down the buckle, and lock it.



2. Charging

VHM22H and VHM22K use two different kind of PCB.

To charge the 22H tablets, use the VHM22H car holder with a 5V/3A adapter.

To charge the 22K tablets, use the VHM22K car holder with a 12V/4A adapter.

3. Expansion interface

The car holder has 5 ports: 1 DC power port, 2 USB2.0 port, 1 RJ45 network port and 1 RS232 serial port.

USB2.0, RJ45 and RS232 can work only when the DC power supply is connected.

4. Accessories and use

4.1 Big ball head



4.2 Small ball head



4.3 Long bracket



4.4 Short bracket



4.5 Clip-on base

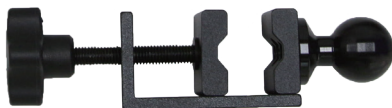

4.6 Instructions for use

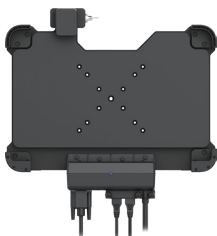

VHM22H/VHM22K



Big ball head

select one of two



Small ball head



Long bracket

select one of two



Short bracket



Clip-on base

select one of two



Big ball head

III. Dimensional drawing

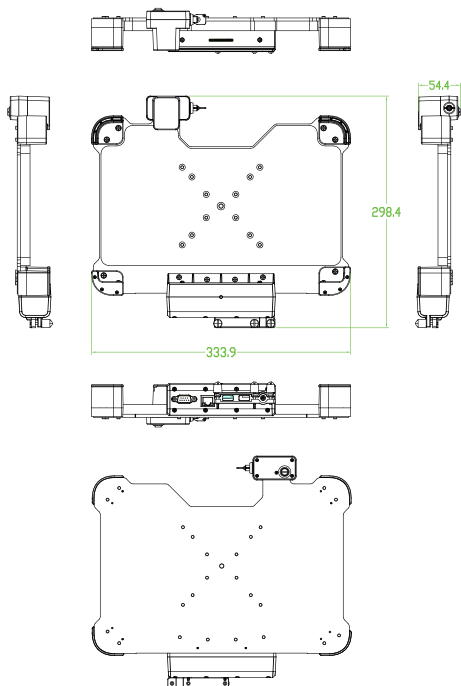

IP SYSTEMES
8 rue du Colonel Chambonnet – BP67
69672 BRON Cedex
Tel.: 04 72 14 18 00
Fax: 04 72 14 18 01
www.ip-systemes.com – info@ip-systemes.fr