

tBOX110 NEW

Fanless Embedded System with Intel Atom® x5-E3940 Processor for Vehicle and Rail PC

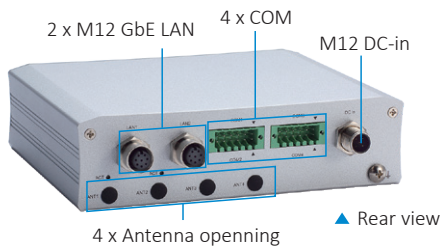
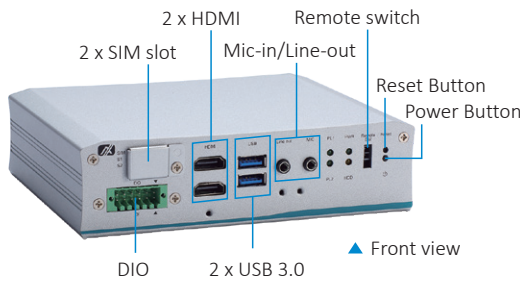

Features

- CE, FCC, LVD, EN 45545-2 and EN 50155 certified; ISO7637-2 compliant
- Intel Atom® x5-E3940 processor
- Fanless and wide operating temperatures from -40°C to +70°C
- Supports 9 to 36VDC and 12/24VDC typical in-vehicle power input
- Supports 24 to 110VDC for railway power input
- Compact size with multiple COM, CANBus, and DIO for communication
- Smart Ignition for power on/off schedule, vehicle battery protection, and different power modes
- Suitable for transportation gateway applications

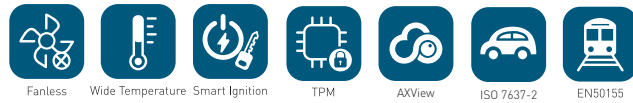

Specifications

Standard Color	Silver	
Construction	Aluminum extrusion and heavy-duty steel, IP20	
CPU	Intel Atom® x5-E3940 4C @1.6 GHz, TDP: 9.5W	
Chipset	SoC integrated	
System Memory	1 x DDR3L-1866 SO-DIMM, up to 8GB	
BIOS	AMI	
System I/O Outlet	Serial	Vehicle: 2 x RS-232/422/485 (4-wire) with shield grounding Railway: 4 x Isolated RS-232/422/485 (4-wire) with shield grounding
	Display	2 x HDMI 1.4b (with keylock)
	CANBus	Vehicle: 2 x Isolated CANBus 2.0 A/B, support SocketCAN
	Audio	1 x Mic-in, 1 x Line-out
	Ethernet	Vehicle : 2 x RJ-45 10/100/1000 Mbps Ethernet (Intel® I210-IT) Railway: 2 x M12 A-coded 10/100/1000 Gbps Ethernet (Intel® I210-IT) 2 x M12 X-coded 10/100/1000 Gbps Ethernet (Intel® I210-IT)
	System I/O Outlet	USB
DIO		Vehicle: 1 x DB9 8-bit programmable DIO Railway: 1 x Terminal block isolated DIO 4-in/4-out (isolation voltage: 2 kV)
Others		1 x Reset button 1 x Power button 1 x Remote switch 4 x Antenna opening
Expansion Interface	2 x Full-size Rev.1.2 PCI Express Mini Card slot: <ul style="list-style-type: none"> • 1 x USB/PCIe with external SIM socket • 1 x mSATA/USB/PCIe with external SIM socket 	
Storage	SATA Drive	1 x Internal 2.5" SATA drive (9.5 mm height)
	mSATA	1 x mSATA (occupied 1 x PCI Express Mini Card slot)



Specifications

Watchdog Timer	255 levels, 1 to 255 sec.	
Power	Power Supply	General use: 1 x Terminal block/M12, 9- 36 VDC Vehicle: 1 x Terminal block, 12/24VDC with Smart Ignition Railway: 1 x M12, 24 to 110VDC
	Power Consumption	Vehicle: 9 VDC, 3.742A; 36VDC, 0.907A Railway: 24 to 110VDC, 0.98A - 0.33A
System Indicator	1 x LED indicator for SATA drive activity 1 x LED indicator for power 2 x LED indicator for LAN activity 2 x Programmable indicator	
Operating Temperature	-40°C to +70°C (-40°F to +158°F) with W.T. peripheral*	
Humidity	0% to 95%, non-condensing	
Dimensions	164.1 mm (6.46") (W) x 128 mm (5.04") (D) x 44.1 mm (1.74") (H) (without wall mount)	
Mounting	Wall mount, DIN-rail (optional)	
Weight (net/gross)	1.02 kg (2.24 lb)/1.44 kg (3.17 lb)	
Certifications	CE, FCC, LVD, EN 45545-2 and EN 50155 certified ; ISO 7637-2 compliant	
EMC	CE/FCC EN 55022 (Class A), EN 55024, EN 50155, EN 50121-3-2, IEC 62236-3-2, FCC part 15 B (Class A)	
Vibration Endurance	3 Grms w/ SSD (5 to 500Hz, X/Y/Z direction; random, operating) 1 Grms w/ HDD (5 to 500Hz, X/Y/Z direction; random, operating) 2 Grms w/ HDD & Anti-Vibration Kit (5 to 500Hz, X/Y/Z direction; random, operating) MIL-STD-810G, Method 514.6C-VI Category 4 compliant	
EOS Support	Windows® 10 64-bit, Ubuntu 20.04	
Software Support	AXView	

*Wide temperature . All W.T. supported products have to be sorted by Axiomtek.

Ordering Information

System

tBOX110-APL-TV (P/N: E26N110100)	Fanless vehicle grade embedded system with Intel Atom® x5-E3940, 2 RJ-45 GbE LAN, terminal block DC-in, 2 USB 3.0, 2 HDMI, 2 COM, DIO, 2 CAN, audio mic-in/line-out, Smart Ignition, TPM 2.0, and 12/24 VDC	
tBOX110-APL-MR2 (P/N: E26N110102)	Fanless embedded system with Intel Atom® x5-E3940, 2 M12 A-code GbE LAN, M12 DC-in, 2 USB 3.0, 2 HDMI, 4 COM, DIO, audio mic-in/line-out, TPM 2.0, and 24 to 110VDC	
tBOX110-APL-MR4 (P/N: TBD)	Fanless embedded system with Intel Atom® x5-E3940, 2 M12 X-code GbE LAN, M12 DC-in, 2 USB 3.0, 2 HDMI, 4 COM, DIO, audio mic-in/ line-out, TPM 2.0, and 24 to 110VDC	

Optional

Communication modules	886N32410A0E	MCR8822CE-P WiFi KIT (20) for tBOX (E)
	886N11012A0E	LTE NL668-JP tBOX110 M1R 2020(E)
	886N11010A0E	LTE LE910C4-AP (20) for tBOX110 (E)
AC to DC adapter	509000001500	PWS FSP120-AAAN3(9NA1206647) FSP 120W
	509000002200	PWS 9NA0908344 FSP 90W
Mounting Kit	886N11011A0E	tBOX110 DIN RAIL KITS (E)
Anti-vibration Kit	8816N1000A0E	tBOX Anti-vibration kit(S) (E)

*Specifications and certifications may vary based on different requirements.

Packing List

1 x Wall mount kit
1 x Thermal pad for memory
4 x Wall mount kit screw
1 x HDMI bracket
1 x Audio bracket
1 x DIO terminal block connector (MR only)
1 x Power 3-pin terminal block connector (TV only)
1 x Rubber for HDD
1 x Cable holder kit

Power Protection

OCP (over current protection)

OVP (over voltage protection)

UVP (under voltage protection)

RPP (reverse polarity protection)

ISO 7637-2 pulse 1, 2a, 2b, 3a, 3b, 4 (vehicle version)

Setting for in-vehicle battery protection: system will be automatically turned down at low voltage level

Setting for ignition control: system will activate a counter while in-vehicle battery at low voltage, ACC-ON delay and shut down delay

Dimensions

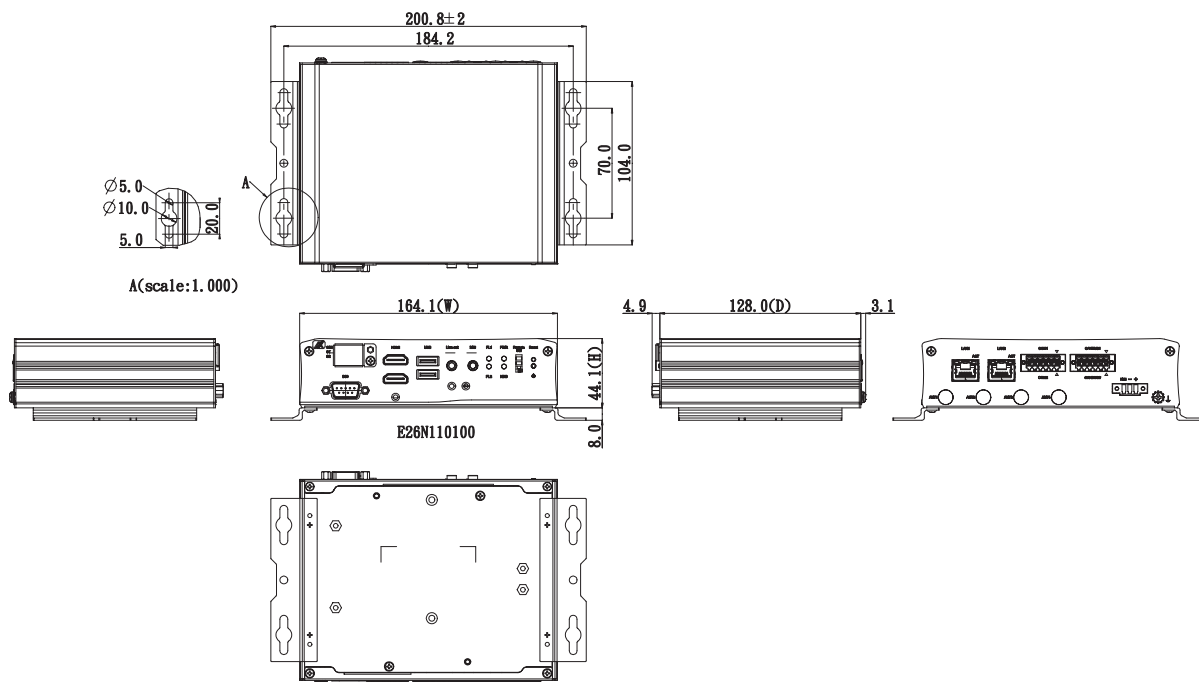

IP SYSTEMES

8 rue du Colonel Chambonnet – BP67

69672 BRON Cedex

Tel. : 04 72 14 18 00

Fax : 04 72 14 18 01

www.ip-systemes.com – info@ip-systemes.fr