



**MITSUBISHI  
ELECTRIC**

*Changes for the Better*

SERVO AMPLIFIERS & MOTORS

for a greener tomorrow



MITSUBISHI SERVO AMPLIFIERS & MOTORS

# MELSERVO JE





Apply servos to all machines with

### Easy To Use

#### Advanced One-Touch Tuning

Servo gains are adjusted with one-touch ease without a personal computer.

#### Tolerance against Instantaneous Power Failure

The instantaneous power failure tough drive function and the large capacity capacitor reduce machine downtime.

#### Absolute Position Detection System NEW

Absolute position detection system can be easily configured with MR-JE-B servo amplifier.

#### Built-in Positioning Function NEW

MR-JE-A has a built-in positioning function, enabling positioning operation with point table method, etc. Equipped with advanced functions such as simple cam and mark detection.

---

MITSUBISHI SERVO AMPLIFIERS & MOTORS

# MELSERVO JE

MR-JE-B for Servo Network is  
now available!



reliable basic performance and advanced ease-of-use!

## High Performance

### SSCNET III/H NEW

MR-JE-B is compatible with 150 Mbps full duplex high-speed optical network SSCNET III/H, achieving high-response system.

### Fast and Accurate

The dedicated engine enables speed frequency response of 2.0 kHz, shortening the tact time.

### High Resolution Encoder

The servo motor is equipped with 131072 pulses/rev (17-bit) high-resolution encoder, achieving high accuracy.

### Energy Conservation

The large capacity main circuit capacitor allows the regenerative energy to be used effectively, reducing energy consumption.

## Global Standard

### Compliance to Global Standards

Global servo, MR-JE series, complies with global standards as standard.

### Sink and Source Connections

Command pulse input and digital input/output are compatible with both sink and source type connections.

### Global Support

FA Centers located throughout the world provide attentive services to support users.

# With Mitsubishi's commitment to total system solutions the MELSERVO-JE becomes the answer to the world-wide

To satisfy your needs of advanced driving control systems, Mitsubishi Electric provides an extensive range of automation and servo motors to programmable controllers, Positioning modules, Human Machine Interfaces and highly developed. With our global support network which provides attentive services including product purchases, after-sales services, we assure you the maximum performance of MELSERVO-JE throughout the world.

## HUMAN MACHINE I/F

### Graphic Operation Terminal



GOT2000 series

### PC/AT compatible computer



## SOFTWARE



## CONTROLLER

### Programmable controller



MELSEC iQ-F series



MELSEC-F series



MELSEC-L series

### Simple Motion module



SSCNET III/H compatible Simple Motion module  
**FX5-40SSC-S**



SSCNET III/H compatible Simple Motion module  
**LD77MS16**  
**LD77MS4**  
**LD77MS2**



SSCNET III/H compatible Simple Motion module  
**QD77MS16**  
**QD77MS4**  
**QD77MS2**



SSCNET III/H compatible Simple Motion module  
**RD77MS16/RD77MS8**  
**RD77MS4/RD77MS2**

### Positioning module



**FX3U-1PG**  
**FX2N-10PG**

## INTERFACE

### SSCNET III/H serial bus

### Pulse train input

## SERVO AMPLIFIER

### MR-JE-B



NEW

SSCNET III/H compatible servo amplifier

### MR-JE-B

### MR-JE-A



Ver. UP

General-purpose interface compatible servo amplifier

### MR-JE-A

## SERVO MOTOR

### Servo motor



Small capacity, low inertia  
**HG-KN series**  
Capacity: 100 to 750 W



Medium capacity, medium inertia  
**HG-SN series**  
Capacity: 0.5 to 3 kW

## SOLUTION



## LINEUP

### Servo amplifier

●: Compatible —: Not compatible

Model	Power supply specification	Rated output [kW]	Command interface			Control mode			
			SSCNET III/H	Pulse train	Analog voltage	Position	Speed	Torque	Positioning function
MR-JE-_B	3-phase 200 V AC	0.1, 0.2, 0.4, 0.6, 0.75, 1, 2, 3	●	—	—	●	●	●	—
MR-JE-_A	3-phase 200 V AC	0.1, 0.2, 0.4, 0.6, 0.75, 1, 2, 3	—	●	●	●	●	●	●

### Servo motor

Series	Rated speed [r/min]
HG-KN series	3000
HG-SN series	2000

\*1. The maximum speed of HG-SN302J



and global supports,  
needs in driving control.

products from servo amplifiers  
solutions.  
technical consulting, and practical training,

Programmable Controller Engineering Software — **MELSOFT GX Works3**  
MELSOFT GX Works2

Servo Setup Software — **MELSOFT MR Configurator2**

**Capacity Selection Software**



MELSEC-Q series



MELSEC iQ-R series



LD75P1/2/4  
LD75D1/2/4



QD75P1/2/4N  
QD75D1/2/4N



QD70P4/8  
QD70D4/8



RD75P2/4  
RD75D2/4

## LOW-VOLTAGE SWITCH GEAR

**Molded-case  
circuit breaker**



WS-V

**Magnetic  
contactor**



MS-T

Mitsubishi Electric's integrated FA solution for achieving seamless information collaboration between information systems and control systems, and enabling lateral integration of production sites.

Mitsubishi Electric's integrated FA platform for achieving lateral integration of controllers & HMI, engineering environments and networks at production sites.

●: Available

Maximum speed [r/min]	Rated output [kW]	With electro-magnetic brake (B)	Oil seal (J)	IP rating*2
5000	0.1, 0.2, 0.4, 0.75	●	●	IP65
3000/2500*1	0.5, 1, 1.5, 2, 3	●	●	IP67

\*1 is 2500 r/min. \*2. The shaft-through portion is excluded.

## INDEX

**MR-JE-B**

SSCNET III/H ..... p. 5  
High Functions for Various Applications ..... p. 6  
Functions of Simple Motion Module ..... p. 6  
Example of Machine Applications .. p. 7

**Easy To Use**

Easy Adjustments ..... p. 9  
For Changes in Power Supply Environment ..... p.10  
Positioning Functions ..... p.11  
Maintenance Functions ..... p.13  
Servo Motors ..... p.14  
Servo Setup Software (MR Configurator2) ..... p.15

**High Performance**

Fast and Accurate ..... p. 17  
Energy Conservation ..... p. 18

**Global Standard**

Global Standards ..... p. 19  
Global FA Centers ..... p. 20

**Product Specifications**

Servo Amplifiers ..... p. 1-1  
Servo Motors ..... p. 2-1  
Options/Peripheral Equipment ..... p. 3-1  
LV5/Wires ..... p. 4-1  
Product List ..... p. 5-1  
Cautions ..... p. 6-1





# SSCNET III/H Compatible MR-JE-B is Newly Released!



## One step forward for your machine performance

MR-JE-B is compatible with SSCNET III/H, optical servo system controller network that enables a high-response and multi-axis system with high synchronous performance and less wiring. In addition, absolute position detection system can be configured easily with the MR-JE-B servo amplifiers.

Together with Simple Motion modules which enable various motion controls including mark detection, electronic cam and advanced synchronous control, MR-JE-B offers the performance that your application demands.

### High System Performance by SSCNET III/H

#### Improving system response

JE-B

#### High-speed Communication

Industry-leading levels

Communication speed has achieved 150 Mbps full duplex (equivalent to 300 Mbps half duplex).

System response is dramatically improved.

\* MR-JE-B is connectable only with SSCNET III/H compatible Simple Motion module (FX5-40SSC-S, QD77MS, LD77MS, and RD77MS).

#### Smooth control

JE-B

#### Communication Cycle of 0.44 ms

Smooth control of machine is possible using high-speed serial communication with cycle times of 0.44 ms.

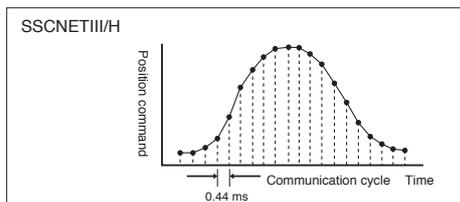

#### Increasing machine performance

JE-B

#### Deterministic and Synchronized Communication

Complete deterministic and synchronized communication is achieved with SSCNET III/H, offering technical advantages in machines such as printing and food processing machines that require synchronous accuracy.

■ Timing of servo amplifier processing

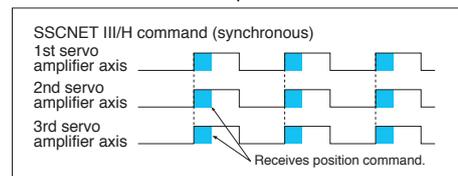
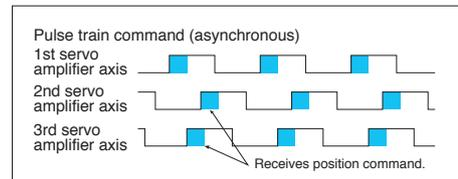

#### Multi-axis system is easily configured

JE-B

#### Maximum 16 Axes per System

Up to 16 servo amplifier axes are connectable per system, making it easy to configure a multi-axis system.

\* MR-JE-B servo amplifier is equipped with hot line forced stop function. When an alarm occurs on MR-JE-B servo amplifier, the hot line forced stop signal will be sent to other servo amplifiers through a controller, and all the servo motors that are operated normally by MR-JE-B servo amplifiers decelerate to a stop.

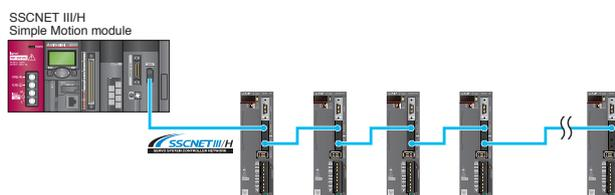

#### Improved noise tolerance

JE-B

#### No Transmission Collision

The fiber-optic cables thoroughly shut out noise that enters from the power cable or external devices. Noise tolerance is dramatically improved as compared to metal cables.

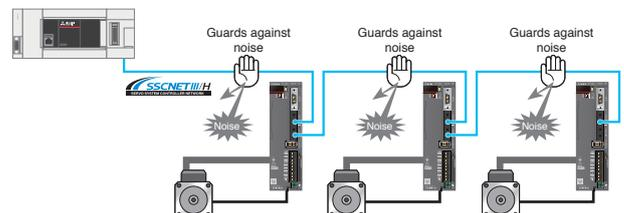

## Equipped with High Functions for Various Applications

**Reduces machine start-up time** **JE-B**

### Absolute Position Detection System

A system using SSCNET III/H let you configure absolute detection system easily just by mounting a battery to the servo amplifiers. In the absolute detection system, home position return at the time of power-on is not necessary, shortening the machine start-up time.

**Compatible with various systems** **JE-B**

### MR-JE-B and MR-J4-B in the Same System

When a servo amplifier of 3.5 kW or larger is necessary, MR-J4-B can be used with MR-JE-B in the same system, allowing to configure various systems.

**Suppresses quadrant protrusion** **JE-B**

### Lost Motion Compensation Function

This function suppresses quadrant protrusion caused by friction and torsion generated when the servo motor rotates in reverse direction. Therefore, the accuracy of circular path will be improved in trajectory control used in XY table, etc.

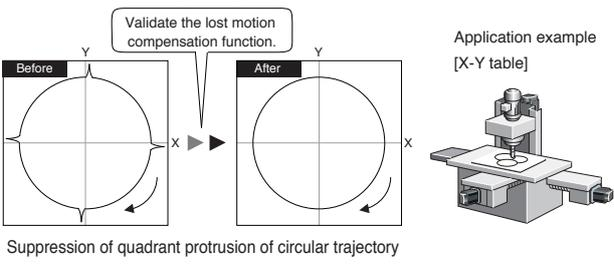

## Advanced Motion Control by Combination with Simple Motion Module

\*MR-JE-B can be connected only with SSCNET III/H compatible Simple Motion module.

## Functions of SSCNET III/H Compatible Simple Motion Module

**Various control modes**

FX5-40SSC	LD77MS
QD77MS	RD77MS

### Position, Speed, Torque Control

Position, speed, and torque controls; and tightening & press-fit control are available. The position control allows to use various functions such as linear/circular interpolation control, fixed-pitch control, and target position change function. In tightening & press-fit control, the control modes between position and torque are switched smoothly.

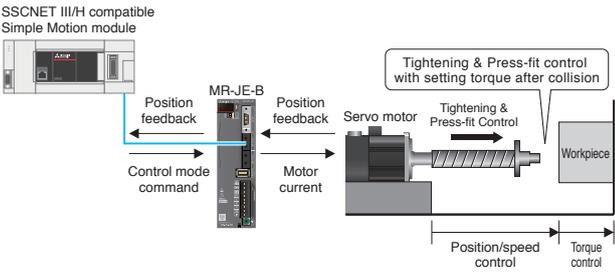

**Highly flexible motion control**

FX5-40SSC	LD77MS
QD77MS	RD77MS

### Cam Function

Control by electronic cam is available. This function enables to create a wide variety of cam data. For example, cam data for a rotary knife can be easily created with the cam auto-generation function, increasing production efficiency.

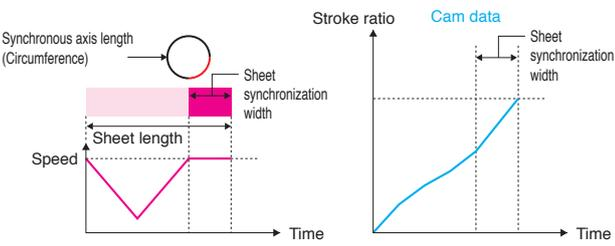

**Easy position compensation**

FX5-40SSC	LD77MS
QD77MS	RD77MS

### Mark Detection Function

The actual position of the servo motor can be obtained based on the inputs from the sensor that detects the registration marks printed on the high-speed moving film. By compensating the cutter axis position errors based on those inputs from the sensor, the film can be cut at the set position.

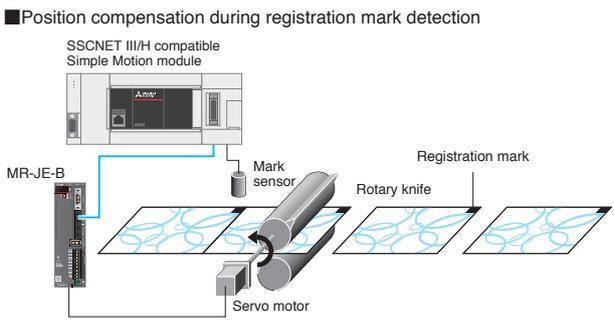

**High-level synchronous control**

FX5-40SSC	LD77MS
QD77MS	RD77MS

### Advanced Synchronous Control

Synchronous control can be easily achieved with software by placing mechanical modules on screen, such as gears, shafts, speed change gears and cams.

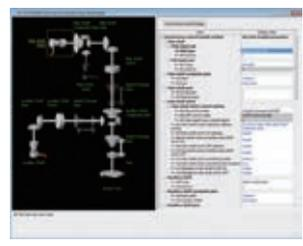

# Achieving Various Machines to be Highly Functional by MR-JE-B and Simple Motion Module.

JE-B	+	FX5-40SSC	LD77MS
		QD77MS	RD77MS

Advanced synchronous control, cam control, and mark detection function

## Packing Machines

When the machine packs food, the whole process is synchronized by using synchronous control and cam control.

The packing film is cut using the registration mark as a reference with the mark detection function.

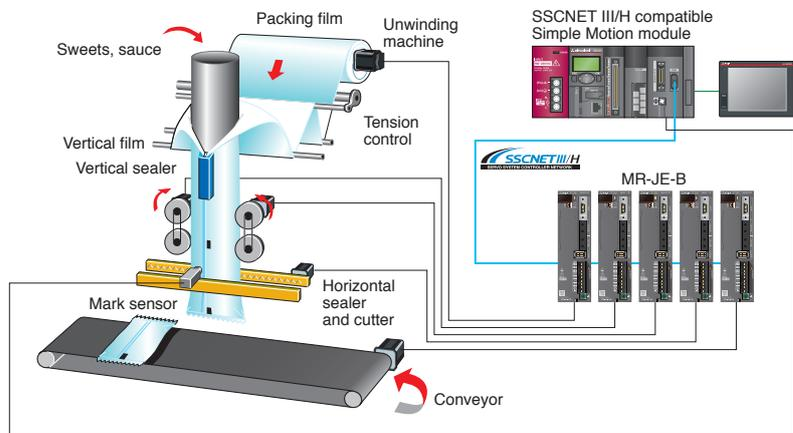

JE-B	+	FX5-40SSC	LD77MS
		QD77MS	RD77MS

Machine resonance suppression filter, instantaneous power failure tough drive, and lost motion compensation

## Simplified Machine Tools

In positioning operation of XY table, workpiece will be processed in high quality by using machine resonance suppression filter that suppresses machine vibration and lost motion compensation function that suppresses quadrant protrusion.

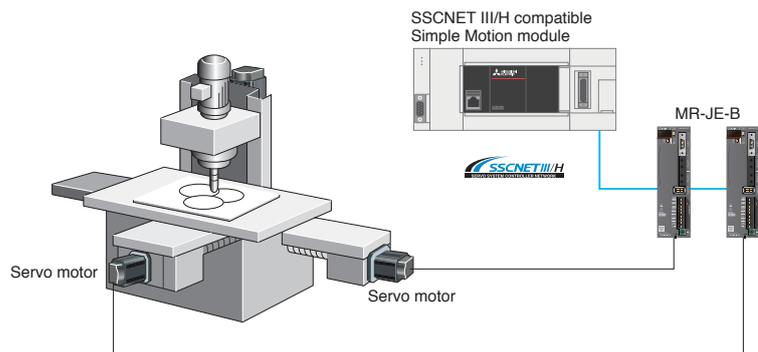

JE-B	+	FX5-40SSC	LD77MS
		QD77MS	RD77MS

Multi-axis synchronous control, tightening & press-fit control, machine resonance suppression filter

## Cap Tightening Machines

Position control can be switched to torque control and vice versa. "Tightening & press-fit control" is also available, switching to torque control without stopping the servo motor during the positioning operation. Since the current position is controlled in any control modes, the positioning is carried out smoothly even after switching back to the position control.

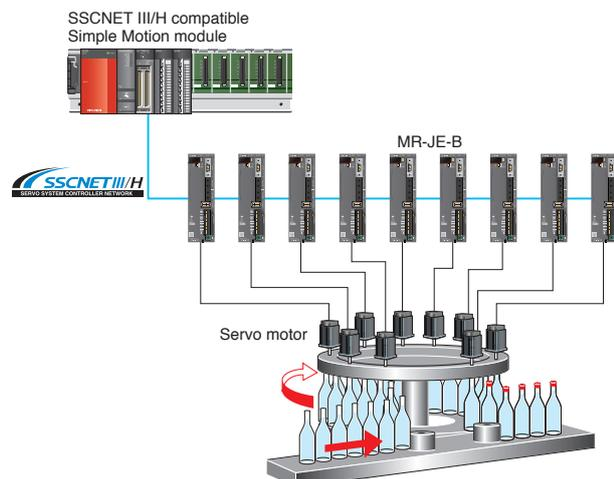





JE-B	+	FX5-40SSC	LD77MS
		QD77MS	RD77MS

One-touch tuning, advanced vibration suppression control II, and cam control

### Robot Material Handling

Servo gains are easily adjusted by using advanced one-touch tuning function. In addition, the advanced vibration suppression control II suppresses low-frequency vibration of a robot hand, resulting in shorter settling time and machine tact time.

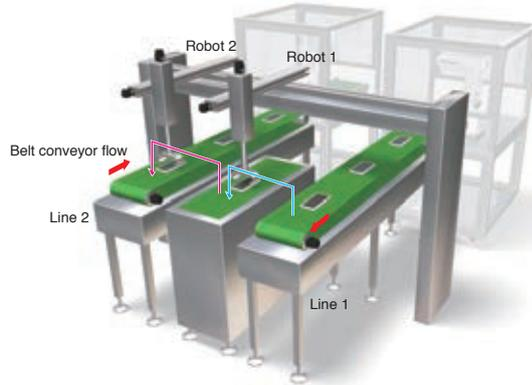

JE-B	+	FX5-40SSC	LD77MS
		QD77MS	RD77MS

Multi-axis synchronous control, speed/torque control, and robust filter

### Unwinders & Rewinders

SSCNET III/H allows to configure a multi-axis synchronous control system even for unwinders & rewinders with multiple axes. For machines with a machining axis, further high-level synchronous control system is possible by using cam control and advanced synchronous control. Because the current position is controlled during the speed or torque control, positioning based on the absolute position coordinate is possible when the control mode is switched to the position control.

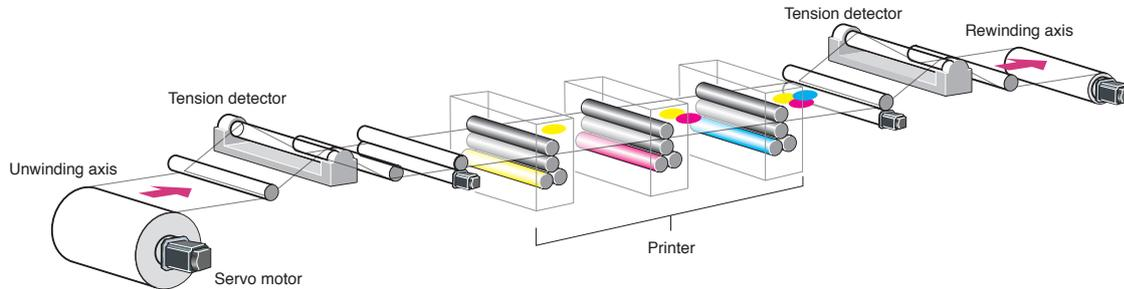

JE-B	+	FX5-40SSC	LD77MS
		QD77MS	RD77MS

Machine resonance suppression filter, advanced vibration suppression control II, and high-resolution encoder

### Testing System

High gain control of servo is available by applying machine resonance suppression filters, enabling high-speed operation patterns.

In addition, advanced vibration suppression control II suppresses vibrations of a hand and an inspection camera, reducing tact time and enabling high quality inspection.

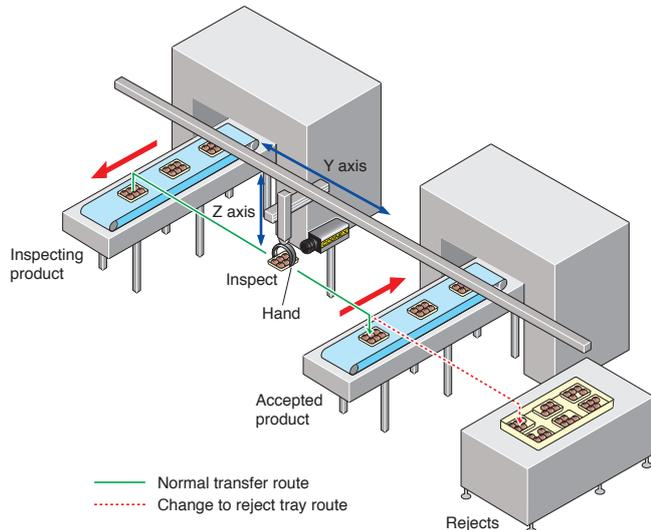

# Easy To Use

MITSUBISHI SERVO AMPLIFIERS & MOTORS  
**MELSERVO-JE**



## Fast, Trouble-Free Setup

Mitsubishi Electric's unique "Advanced one-touch tuning" enables servo gain adjustment with one-touch ease. The increased tolerance against instantaneous power failure, the ease of maintenance, and the simple setup software would add further usability for all MELSERVO-JE users.

MELSERVO-JE

## High-Precision Tuning

Servo gain adjustment with one-touch ease

JE-B

JE-A

### Advanced One-Touch Tuning Function

Servo gain adjustment is complete just by turning on the one-touch tuning function. With this function, machine resonance suppression filter, advanced vibration suppression control II\*, and robust filter are automatically adjusted to maximize your machine performance.

\* The advanced vibration suppression control II automatically adjusts one frequency.

MR-JE-B

Adjust the servo gain just by pressing the "Start" button on one-touch tuning window of MR Configurator2.



MR-JE-A

Adjust the servo gains just by pressing the buttons on the front of the servo amplifier.

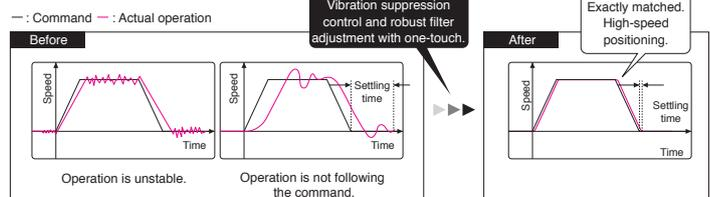
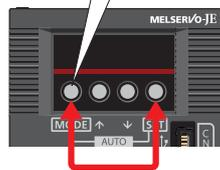

Suppress two types of low frequency vibrations at once

JE-B

JE-A

### Advanced Vibration Suppression Control II

Patent pending

The advanced vibration suppression control II suppresses two types of low frequency vibrations owing to vibration suppression algorithm which supports three-inertia system. This function is effective in suppressing residual vibration generated at the end of an arm and in a machine, enabling a shorter settling time. Adjustment is easily performed on MR Configurator2.

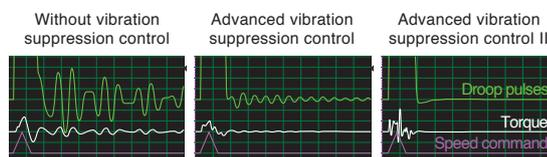
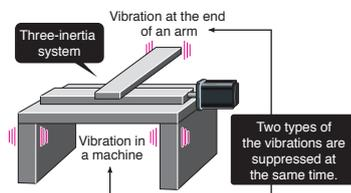



Wide frequency range

JE-B

JE-A

### Machine Resonance Suppression Filter

With advanced filter structure, applicable frequency range is expanded to between 10 Hz and 4500 Hz. Additionally, the number of simultaneously applicable filters is increased to five, improving vibration suppression performance of a machine.

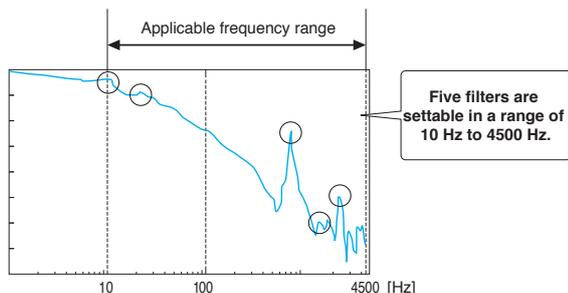

High responsivity and stability

JE-B

JE-A

### Robust Filter

Patent pending

Achieving both high responsivity and stability was difficult with the conventional control in high-inertia systems with belts and gears such as printing and packaging machines. Now, this function enables the high responsivity and the stability at the same time without adjustment. The robust filter gradually reduces the fluctuation of torque in wide frequency range and achieves more stability as compared to the prior model.

Machine with a high-inertia ratio

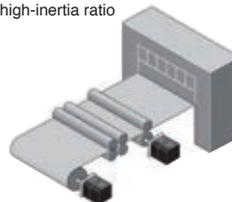

Robust filter

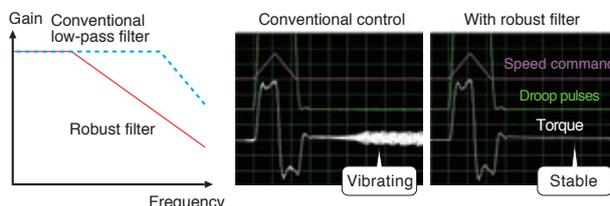

## For Changes in Power Supply Environment

Reduce machine downtime

JE-B

JE-A

### Large Capacity Main Circuit Capacitor

The capacity of main circuit capacitor is increased by 20% as compared to the previous model, increasing the tolerance against instantaneous power failure. The increased tolerance reduces machine downtime and then improves productivity.

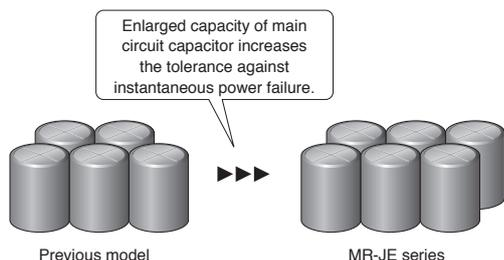

Reduce undervoltage alarms

JE-B

JE-A

### Instantaneous Power Failure Tough Drive

When an instantaneous power failure is detected, this function allows the servo amplifier to use the electric energy charged in the main circuit capacitor in the servo amplifier to avoid an alarm occurrence, increasing the machine availability even with an unstable power supply.

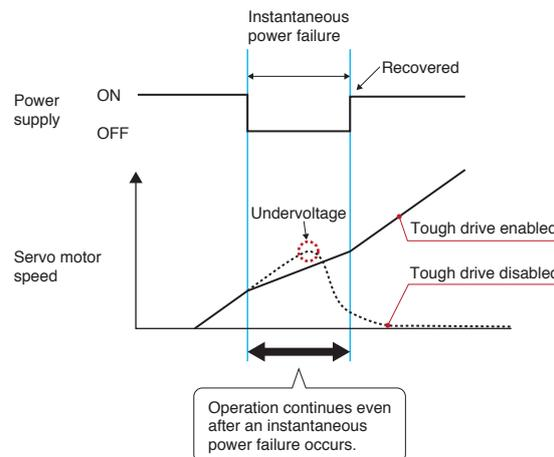

Wide power supply voltage input range

JE-B

JE-A

### Compatible with 1-phase 200 to 240 V AC Input NEW

Servo amplifiers of 2 kW or smaller are compatible with power supply voltage of 1-phase 200 V AC to 240 V AC.

\* When 1-phase 200 V AC to 240 V AC power supply is used with servo amplifiers of 1 kW and 2 kW, use the servo amplifiers with 75% or less of the effective load ratio. The servo amplifiers of 1 kW and 2 kW cannot be mounted closely when 1-phase power is input.



**NEW**

# MR-JE-A is now equipped with Positioning Function.

Positioning operation with point table and program based methods became capable by built-in positioning function in MR-JE-A\*, allowing to configure positioning system without controller such as Positioning module.

Features:

- Equipped with simple cam, encoder following, and mark detection functions, making it possible to increase machine functionality.
- Command interface compatible with DIO or RS-422/RS-485 serial communication (maximum 32 axes)
- Easy setting of positioning data from MR Configurator2.

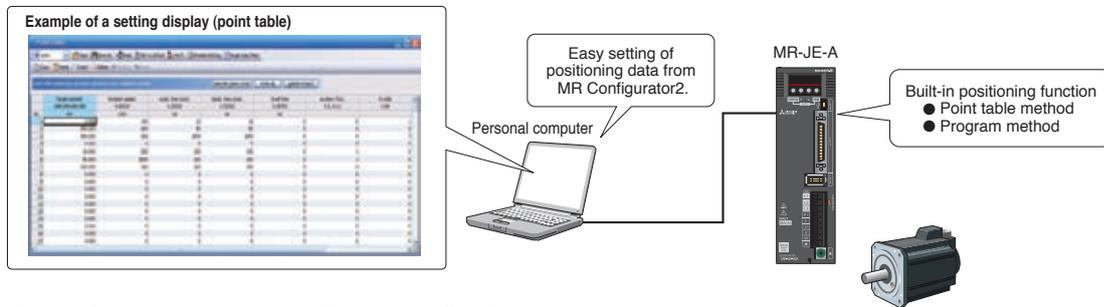

\*1. Use MR-JE-A servo amplifiers with software version B7 or later when using the positioning function.

## MELSERV o JE A Variety of Positioning Functions

### Easy to set a positioning data JE-A

#### Point Table Method

Setting position data (target position), servo motor speed, and acceleration/deceleration time constants in point table is as easy as setting a parameter. Up to 31 points are settable for the point table. The positioning operation is performed with a start signal after selecting the point table No.

Point table example

Point table No.	Position data	Servo motor speed	Acceleration time constant	Deceleration time constant	Dwell	Sub function	M code
1	1000	2000	200	200	0	1	1
2	2000	1600	100	100	0	0	2
⋮	⋮	⋮	⋮	⋮	⋮	⋮	⋮
31	3000	3000	100	100	0	2	99

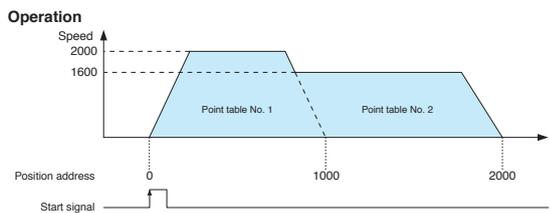

### Easy operation by program JE-A

#### Program Method\*

Create positioning programs with dedicated commands. The positioning operation is performed with a start signal after selecting the program No. The program method enables more complex positioning operation than the point table method. Maximum of 16 programs are settable. (The total number of steps of program: 480)

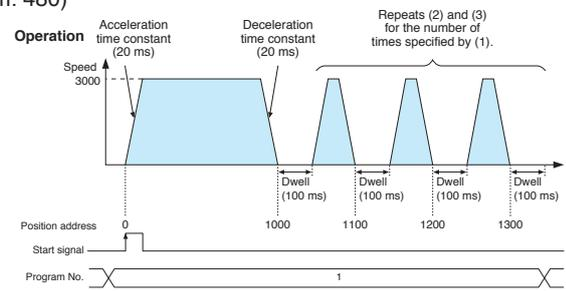
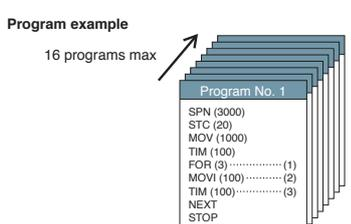

\* MR Configurator2 is required to create programs.

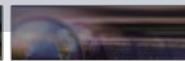

Easy to create electronic cam

JE-A

### Simple Cam Function

Various patterns of cam data\* can be created easily by using MR Configurator2. Command pulse or point table/program start signal can be used as input to the simple cam. The input command will be outputted to the servo motor according to the cam data.

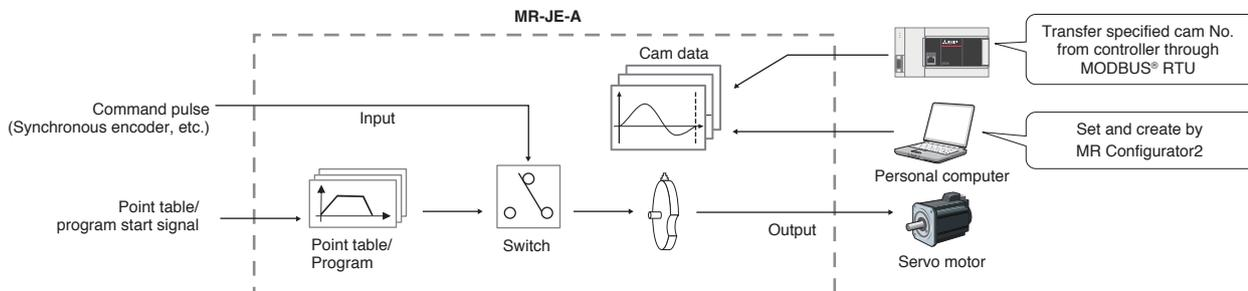

\* Cam curve can be selected from 12 types (constant speed/constant acceleration/5th curve/single hypotenuse/cycloid/distorted trapezoid/distorted sine/distorted constant speed/trapezoid/reverse trapezoid/double hypotenuse/reverse double hypotenuse). For details of simple cam function, refer to p.1-25 in this catalog.

Synchronous operation by encoder signal input

JE-A

### Encoder Following Function/Command Pulse Input Through Function

With the encoder following function, the servo amplifier receives A/B-phase output signal from the synchronous encoder as command pulse, and the input command will be outputted to the servo motor according to the cam data. By setting cam data that matches with sheet length, a diameter of the rotary knife axis, and synchronous section of the sheet; a system in which the conveyor axis and the rotary knife axis are synchronized can be configured. Up to 4 Mpulses/s of input from synchronous encoder is compatible with the servo amplifier.

The command pulse input through function allows the first axis to output A/B-phase pulse from the synchronous encoder to the next axis, enabling a system the second and later axes are synchronized with the synchronous encoder.

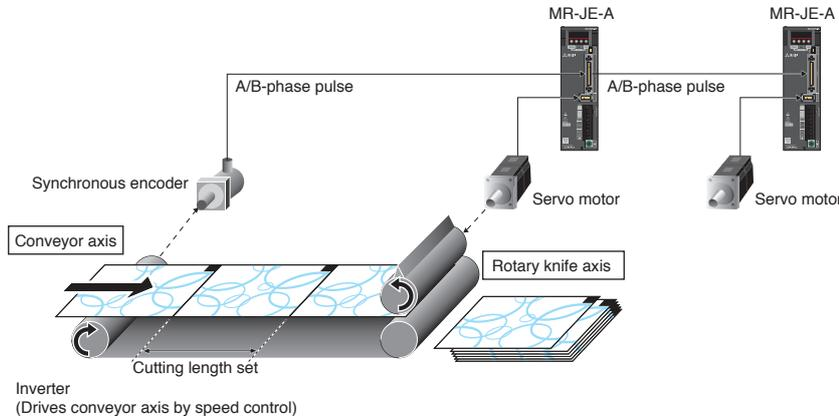

Compensating a position gap by sensor input

JE-A

### Mark Sensor Input Compensation Function

The actual position of the servo motor can be obtained based on the inputs from the sensor that detects the registration marks printed on the high-speed moving film. The servo amplifier calculates compensation amounts and corrects position errors of the rotary knife axis based on those inputs from the sensor so that the film can be cut at the set position.

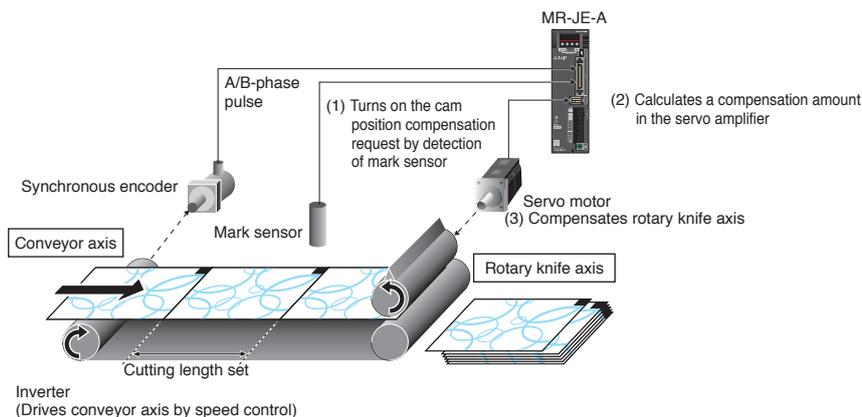

Compatible with MODBUS® protocol

JE-A

Communication Function (MODBUS® RTU)

NEW

In addition to RS-422 communication (Mitsubishi general-purpose AC servo protocol), RS-485 communication (MODBUS® RTU protocol) is supported.

MODBUS® RTU protocol is compatible with function code 03h (Read holding registers), etc. Controlling and monitoring the servo amplifier by external devices is possible.

Compatible function code

03h	Read holding registers
08h	Diagnostics
10h	Preset multiple registers

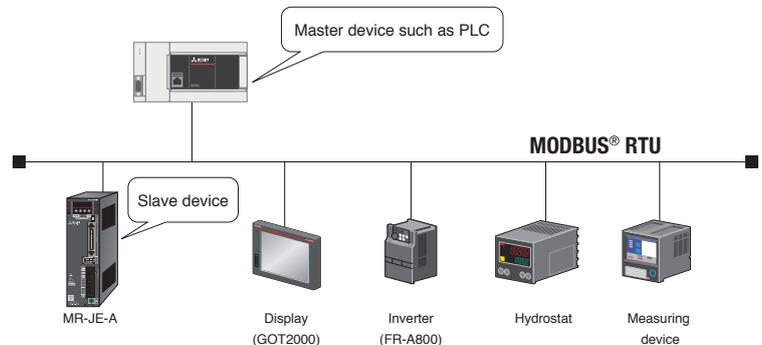

Point to Point positioning

While the point table is in operation, the next target position of the point table can be overwritten.

Current position latch

While the point table is in operation, the position data is latched by the mark detection function, and the current position latch function let the controller to obtain the latched data.

Analyze cause of alarm

JE-B

JE-A

Large Capacity Drive Recorder

Patent pending

- Servo data such as motor current and position command before and after the alarm occurrence are stored in non-volatile memory of the servo amplifier. Reading the servo data on MELSOFT MR Configurator2 helps you analyze the cause of the alarm.
- Check the waveform ((analog 16 bits × 7 channels + digital 8 channels) × 256 points) and the monitor values of 16 alarms in the alarm history.

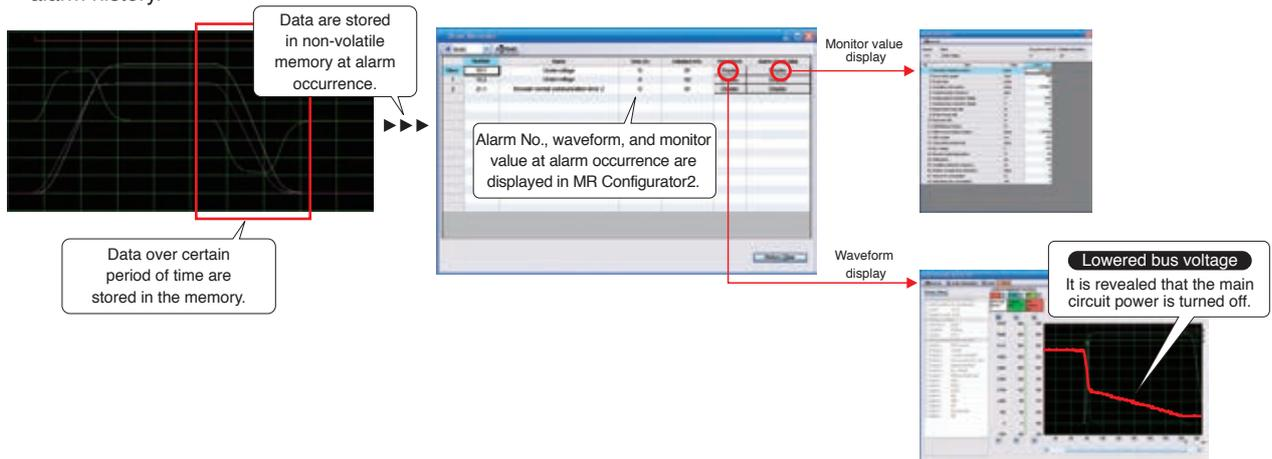

Reduce machine downtime incurred by age-related deterioration

JE-B

JE-A

Vibration Tough Drive

Machine resonance suppression filter is automatically readjusted when a change in machine resonance frequency is detected by the servo amplifier. Losses from the machine stop due to age-related deterioration are reduced.

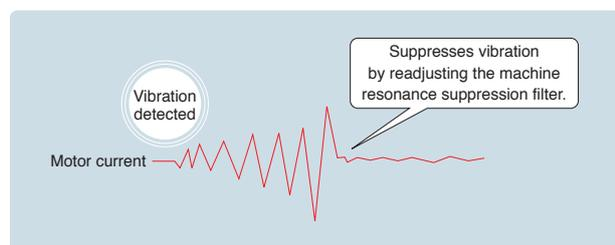



Support optimal maintenance of driving parts

JE-B JE-A

Machine Diagnosis Function

Patent pending

This function detects changes of machine parts (ball screw, guide, bearing, belt, etc.) by analyzing machine friction, load moment of inertia, unbalanced torque, and changes in vibration component from the data inside the servo amplifier, supporting timely maintenance of the driving parts.

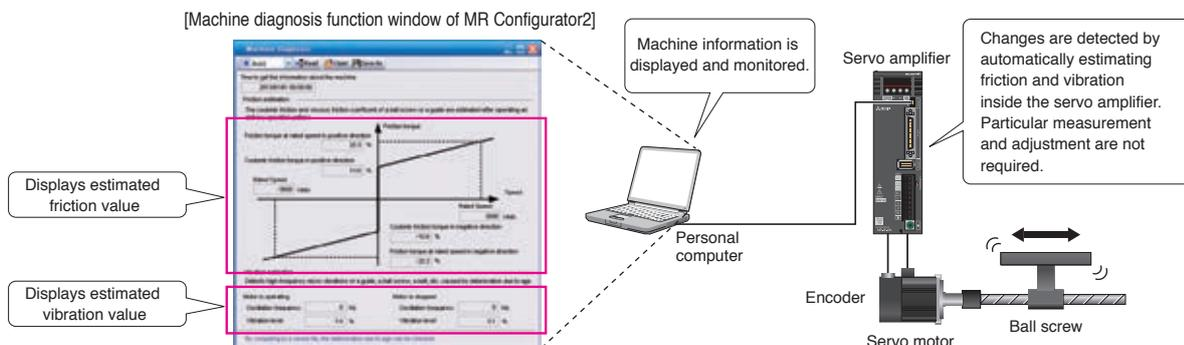

Easy troubleshooting

JE-B JE-A

Three-Digit Alarm

MR-JE series displays the alarm No. in three digits to show the servo alarm in more details, making troubleshooting easy.

[Example of an alarm window on MR Configurator2]

[Three-digit alarm display]



This display is of MR-JE-A.

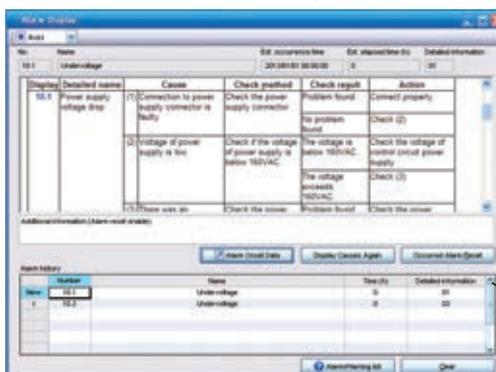

The alarm No. shows whether the undervoltage alarm was caused by instantaneous power failure or by lowered bus voltage in the servo amplifier.

Even in severe environment

Improved Environment Safety

HG-KN series and HG-SN series are rated IP65 and IP67 respectively.

\* The shaft-through portion is excluded.



Cable leading in both ways

Selectable Cable Leading Direction

The power cable, the encoder cable, and the electromagnetic brake cable are led out to either in direction of or in opposite direction of the load side, depending on the selected cables. (HG-KN series)

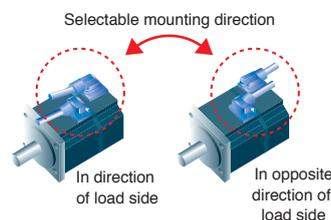

The easy-to-use design MR-JE series makes startup and adjustment that simple.

Servo setup software

# MR Configurator2 (SW1DNC-MRC2-E)

Tuning, monitor display, diagnosis, reading/writing parameters, and test operations are easily performed on a personal computer.

This startup support tool achieves a stable machine system, optimum control, and short setup time.



## MELSER/o-JE Preparation

Just follow the guidance, and setup is complete **JE-B** **JE-A**

### Servo Assistant Function

Complete setting up the servo amplifier just by following guidance displays. Setting parameters and tuning are easy since related functions are called up from shortcut buttons.

So simple!  
Just follow  
the guidance.

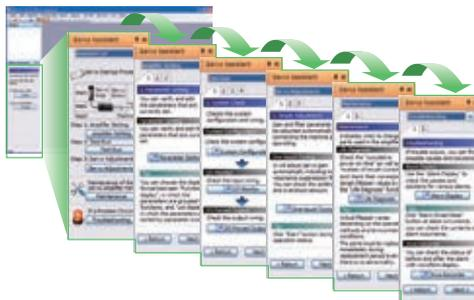

Supporting replacement from conventional system **JE-A**

### Parameter Converter Function

With this function, parameter files for MR-E series or MR-E Super series are converted to those for MR-JE-A series.

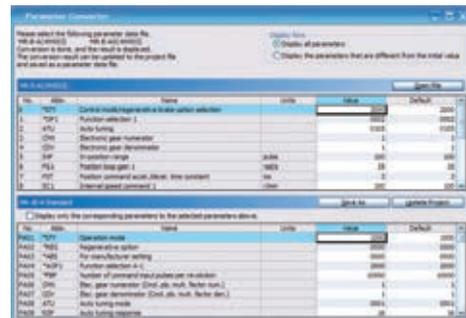

## MELSER/o-JE Setting and Start-up

Easy and fast parameter setting **JE-B** **JE-A**

### Parameter Setting Function

Display parameter setting in list or visual formats, and set parameters by selecting from the drop down list. Set in-position range in mechanical system unit (e.g.  $\mu\text{m}$ ). Parameter read/write time is approximately one tenth of the conventional time.

Set without  
manuals.

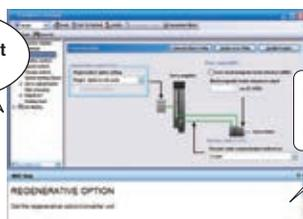

Display details of  
relevant parameters  
in a docking window.

Visible operation and power status **JE-B** **JE-A**

### Monitor Function

Monitor operation status on the [Display all] window. Check power consumption without any measurement equipment such as electric power meter, assign input/output signals, and monitor ON/OFF status on the [I/O monitor] window.

[Display all] window

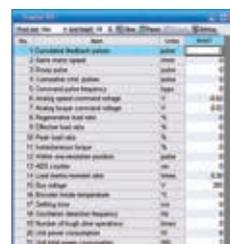

[I/O monitor] window

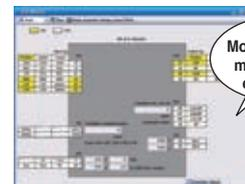

Monitor without  
measurement  
equipment.



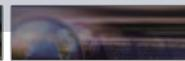

# Servo Adjustment

Tuning is just one click away **JE-B** **JE-A**

## One-Touch Tuning Function

Adjustments including estimating load to motor inertia ratio, adjusting gain, and suppressing machine resonance are automatically performed for the maximum servo performance just by clicking the start button. Check the adjustment results of settling time and overshoot.

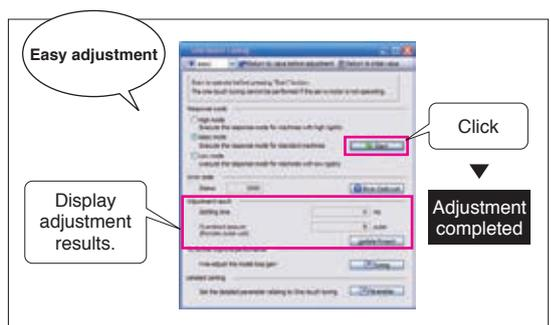

Fine tuning of loop gain **JE-B** **JE-A**

## Tuning Function

Adjust control gain finely on the [Tuning] window manually for further performance after the one-touch tuning.

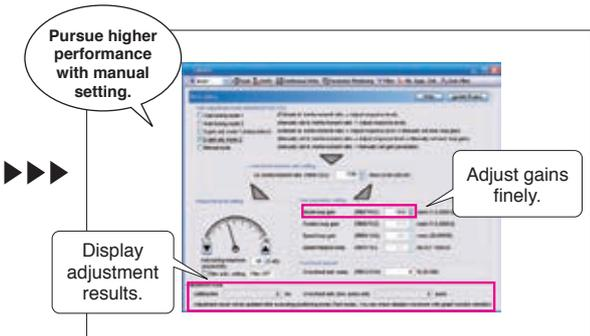

Convenient with overwrite and graph history functions **JE-B** **JE-A**

## Graph Function

The number of measurement channels is increased to 7 channels for analog, and 8 channels for digital. Display various servo statuses in the waveform at one measurement, supporting setting and adjustment. Convenient functions such as [Overwrite] for overwriting multiple data and [Graph history] for displaying graph history are available.

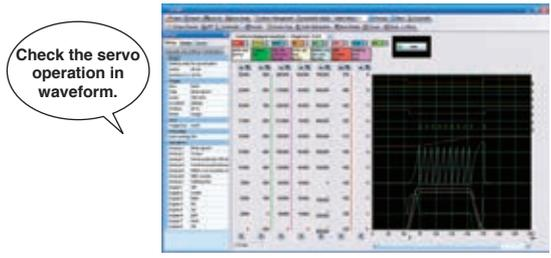

Analyze the frequency characteristics **JE-B** **JE-A**

## Machine Analyzer Function

Input random torque to the servo motor automatically and analyze frequency characteristics (0.1 Hz to 4.5 kHz) of a machine system just by clicking the [Start] button. This function supports setting of machine resonance suppression filter, etc.

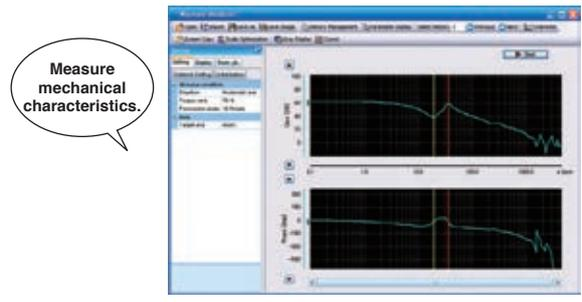

# Maintenance

For timely parts replacement **JE-B** **JE-A**

## Servo Amplifier Life Diagnosis Function

Check cumulative operation time and on/off times of inrush relay. This function provides an indication of replacement time for servo amplifier parts such as capacitor and relays.

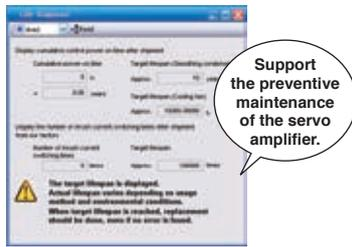

Find out the aging deterioration of machines **JE-B** **JE-A**

## Machine Diagnosis Function

Patent pending

This function estimates and displays machine friction and vibration in normal operation without any special measurement. Comparing the data of the first operation and after years of operation helps to find out the aging deterioration of a machine and is beneficial for preventive maintenance.

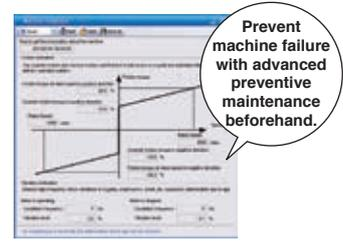

# High Performance

MITSUBISHI SERVO AMPLIFIERS & MOTORS  
**MELSERVO-JE**



## Further Reduction of Tact Time

Top-level basic performance is achieved, including speed frequency response of 2.0 kHz. The MELSERVO-JE series that utilizes regenerative energy maximizes the machine performance and energy saving.

MELSERVO-JE

Fast and Accurate

Class top-level speed frequency response **JE-B** **JE-A**

### 2.0 kHz Speed Frequency Response

The top-level speed frequency response of 2.0 kHz shortens the settling time substantially, reducing the tact time of a machine.

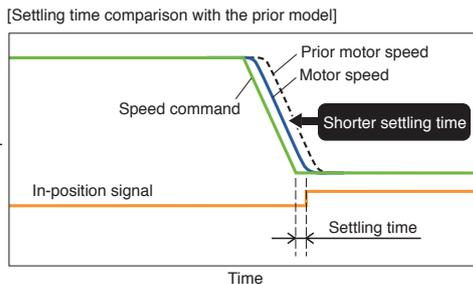

Exact positioning **JE-B** **JE-A**

### High-Resolution Encoder

The servo motor equipped with an incremental encoder\* of 131072 pulses/rev (17-bit) enables high-accuracy positioning and smooth rotation.

\* MR-JE-A is not compatible with absolute position detection system.



Equipped with high-resolution incremental encoder.

Further smooth operation **JE-A**

### Max Command Pulse Frequency of 4 Mpulses/s

MR-JE-A having a general-purpose interface is compatible with the maximum command pulse frequency of 4 Mpulses/s, enabling smooth operation.

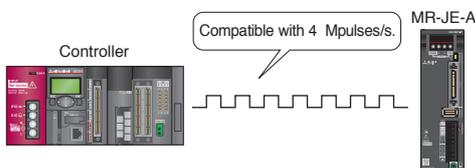

Smooth, constant-speed operation **JE-B** **JE-A**

### Reduced Torque Ripple during Conduction

By optimizing the combination of the number of motor poles and the number of slots, torque ripple during conduction is greatly reduced. Smooth constant-velocity operation of a machine is achieved.

■ Torque ripple

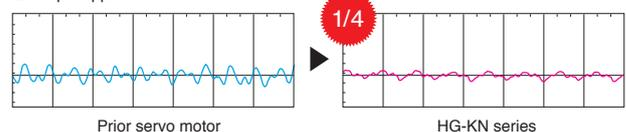

Compatible with pulse train and analog

JE-A

### Flexible Command Interface

The command interface of MR-JE-A is compatible with both pulse train command and analog voltage command. The MR-JE-A servo amplifier enables position control with pulse train command, and speed and torque control with analog voltage command.

MELSERVO-JE

## Eco-Friendly Performance

Reduce waste in energy consumption

JE-B

JE-A

### Efficient Utilization of Regenerative Energy

Capacity of the main circuit capacitor is increased by 20% compared to that of the prior model, and thus the charging capacity is increased, enabling larger regenerative energy to be reused as driving power energy. Additionally, because the control circuit and the main circuit use a common power supply, the regenerative energy is also used for the control circuit, reducing waste in energy consumption.

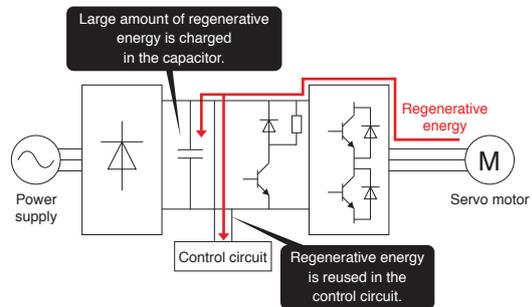

Visualize power consumption

JE-B

JE-A

### Power Monitor

Driving power and regenerative energy are calculated from the data in the servo amplifier such as speed and current, and the power consumption is monitored with MR Configurator2. Visualization of the power consumption helps to save energy.

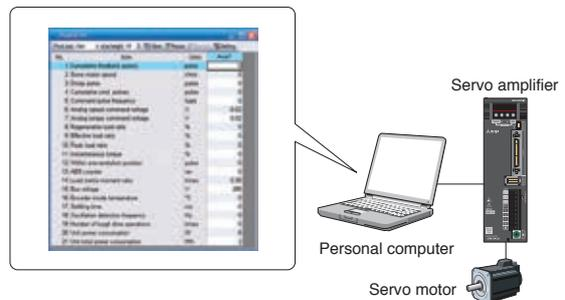

Achieve further energy saving

JE-B

JE-A

### Saving Energy with Advanced Technologies

#### Reducing energy loss of the servo amplifier

Efficiency is increased by the use of a new power module. Energy loss of the servo amplifier itself is reduced.



#### Saving energy by improving machine performance

The servo amplifiers and the servo motors with the industry-leading level of high performance reduce machine tact time and operation time, resulting less energy consumption.

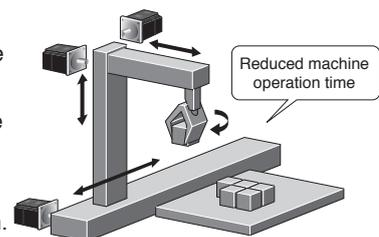

# Global Standard

MITSUBISHI SERVO AMPLIFIERS & MOTORS  
**MELSERVO-JE**



## Fully Compliant Worldwide

To satisfy growing needs in driving control throughout the world, the MR-JE series complies with global standards.

Command pulse input and digital input/output are compatible with both sink and source type connections.

MELSERVO-JE

Global Servo Meets Global Standards

Best quality all over the world

JE-B JE-A

### Conformity with Global Standards and Regulations

Use the MR-JE series globally. The servo amplifiers and the servo motors conform to global standards as standard.

#### Conformity with global standards and regulations



		Servo amplifier	Servo motor
European EC directive	Low voltage directive	EN 61800-5-1	EN 60034-1
	EMC directive	EN 61800-3	EN 60034-1
	RoHS directive	Compliant	Compliant
UL standard		UL 508C	UL 1004-1 / UL 1004-6
CSA standard		CSA C22.2 No.14	CSA C22.2 No.100
Measures for Administration of the Pollution Control of Electronic Information Products (Chinese RoHS)		Compliant (optional cables and connectors)	Compliant (optional cables and connectors)
China Compulsory Certification (CCC)		N/A	N/A
Korea Radio Wave Law (KC)		Compliant	N/A

\*1. Refer to "Servo Amplifier Instruction Manual" and "EMC Installation Guidelines" when your system needs to meet the EMC directive.  
\*2. When exporting the product, follow the local laws and regulations.

Flexible connections for the global use

JE-B JE-A

### Sink and Source Connections

Command pulse input and digital input/output are compatible with both sink and source type connections.

#### Example of digital input

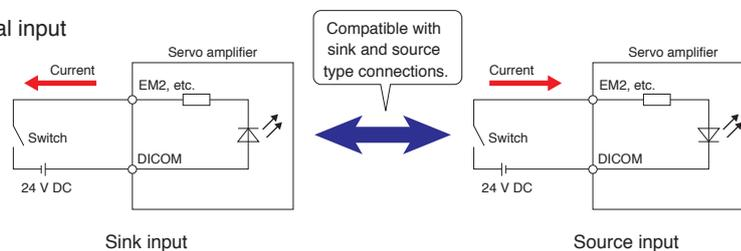



**MELSERVO-JE** Extensive Global Support Network

Supporting MELSERVO users worldwide

**Global FA Centers**

Across the globe, FA Centers provide customers with local assistance for purchasing Mitsubishi Electric products and with after-sales services. To enable national branch offices and local representatives to work together in responding to local needs, we have developed a service network throughout the world. We provide repairs, on-site engineering support, and sales of replacement parts. We also provide various services from technical consulting services by our expert engineers to practical training for equipment operations.

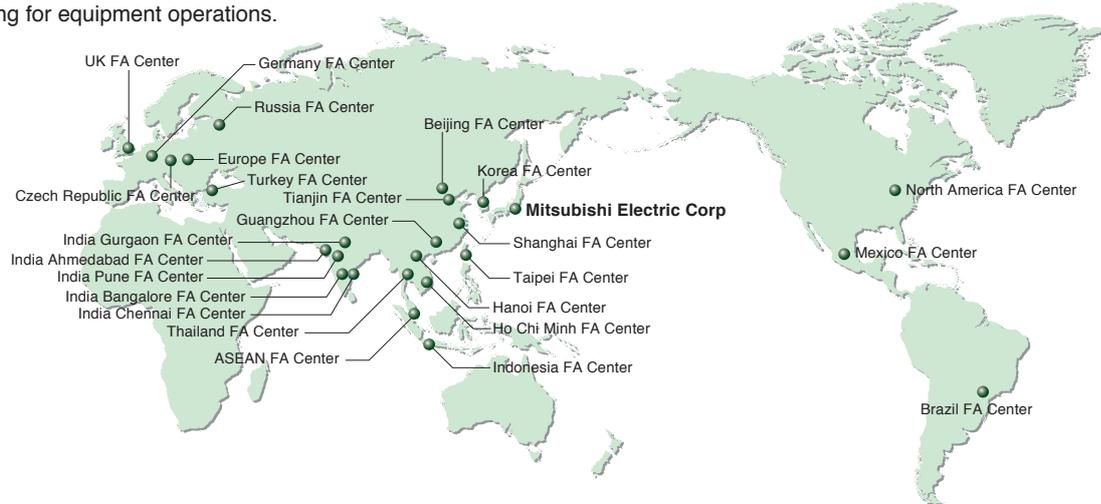

**Shanghai, China**  
Shanghai FA Center



**Seoul, Korea**  
Korea FA Center



**Pune/Gurgaon/Bangalore/  
Chennai/Ahmadabad, India**  
India FA Center



**Ratingen, Germany**  
Germany FA Center/  
Europe Development Center



**Beijing, China**  
Beijing FA Center



**Bangkok, Thailand**  
Thailand FA Center



**Chicago IL, U.S.A.**  
North America FA Center/  
North American Development Center



**Hatfield, U.K.**  
UK FA Center



**Tianjin, China**  
Tianjin FA Center



**Singapore**  
ASEAN FA Center



**Tlalneantla Edo., Mexico**  
Mexico FA Center



**Praha, Czech Republic**  
Czech Republic FA Center



**Guangzhou, China**  
Guangzhou FA Center



**Bekasi, Indonesia**  
Indonesia FA Center



**Sao Paulo SP, Brazil**  
Brazil FA Center



**St. Petersburg, Russia**  
Russia FA Center



**Taipei/Taichung, Taiwan**  
Left: Taipei FA Center/  
Right: Taichung FA Center



**Hanoi/Ho Chi Minh, Vietnam**  
Left: Hanoi FA Center/  
Right: Ho Chi Minh FA Center



**Krakowska, Poland**  
Europe FA Center (Poland)



**Istanbul, Turkey**  
Turkey FA Center

MEMO

---

# 1

Model Designation.....	1-1
Combinations of Servo Amplifier and Servo Motor .....	1-1
MR-JE-B	
Connections with Peripheral Equipment.....	1-2
Specifications .....	1-3
Standard Wiring Diagram Example .....	1-4
Power Supply Connection Example .....	1-5
Servo Motor Connection Example.....	1-6
Dimensions.....	1-7
MR-JE-A	
Connections with Peripheral Equipment.....	1-8
Specifications .....	1-9
Standard Wiring Diagram Example .....	1-10
RS-422 Serial Communication Connection Example ...	1-14
RS-485 Serial Communication Connection Example ...	1-14
MODBUS® RTU Specification .....	1-15
Power Supply Connection Example .....	1-16
Positioning Function .....	1-17
Simple Cam Specification.....	1-25
Dimensions.....	1-26

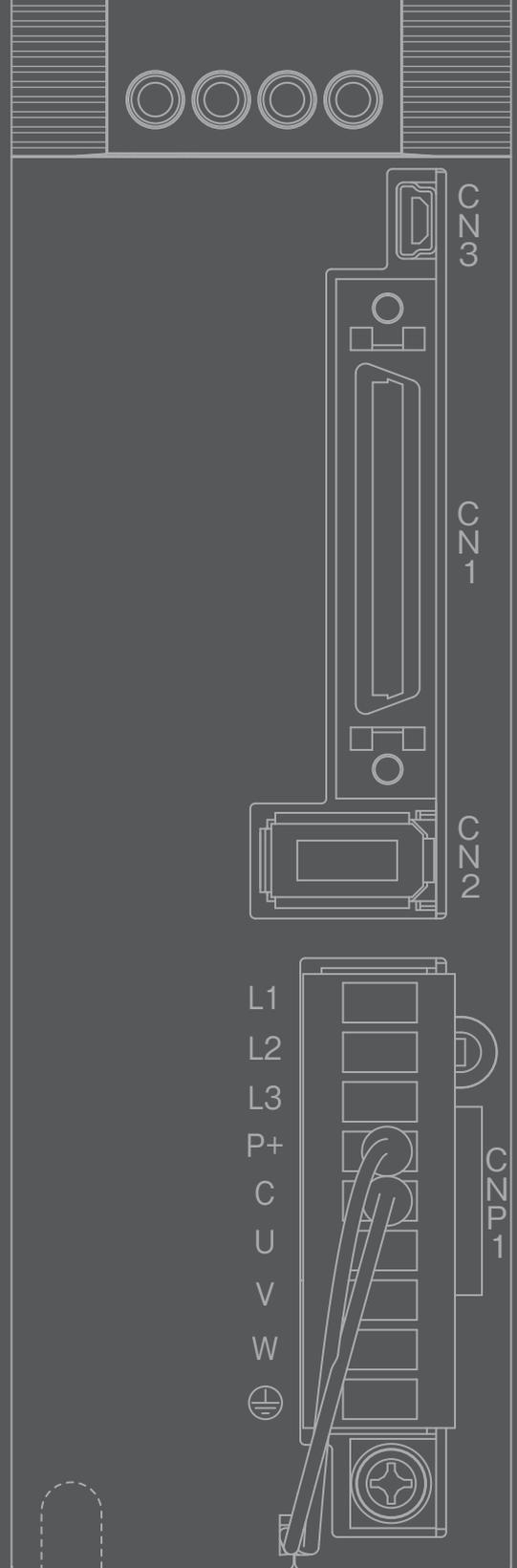

## Servo Amplifiers

## Servo Amplifier Model Designation

B

A

MR-JE-10B

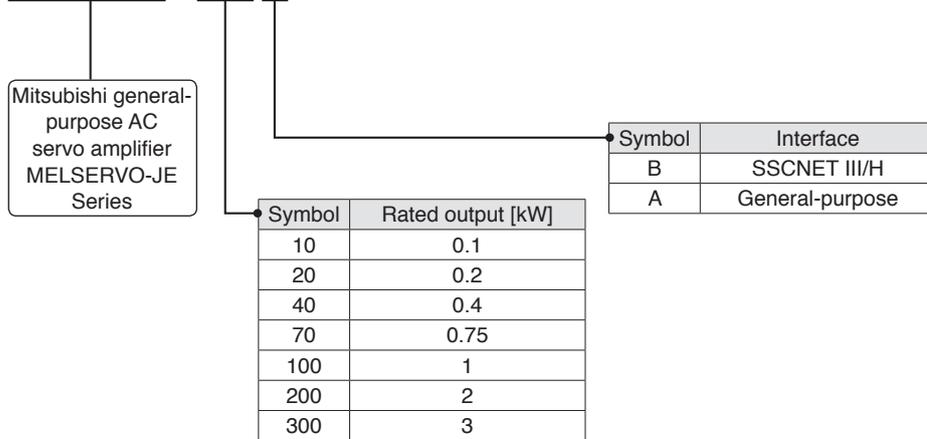

## Combinations of Servo Amplifier and Servo Motor

B

A

Servo amplifier	Servo motor	
	HG-KN series	HG-SN series
MR-JE-10B/MR-JE-10A	HG-KN13J	-
MR-JE-20B/MR-JE-20A	HG-KN23J	-
MR-JE-40B/MR-JE-40A	HG-KN43J	-
MR-JE-70B/MR-JE-70A	HG-KN73J	HG-SN52J
MR-JE-100B/MR-JE-100A	-	HG-SN102J
MR-JE-200B/MR-JE-200A	-	HG-SN152J, HG-SN202J
MR-JE-300B/MR-JE-300A	-	HG-SN302J



## MR-JE-B Connections with Peripheral Equipment (Note 1)

B

Peripheral equipment is connected to MR-JE-B as described below. Connectors, cables, options, and other necessary equipment are available so that users can set up the servo amplifier easily and start using it right away.

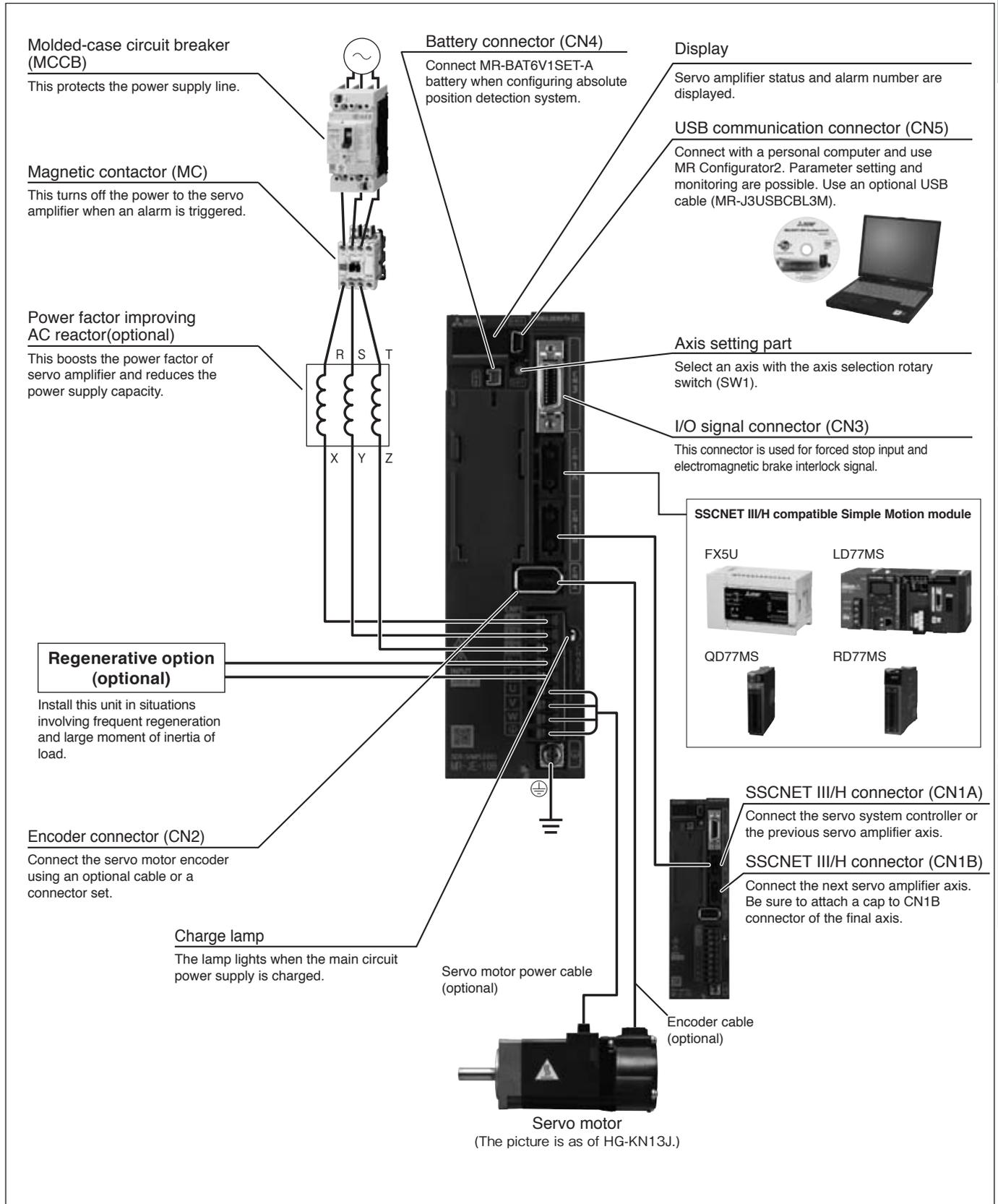

Notes: 1. The connection with the peripheral equipment is an example for MR-JE-100B or smaller servo amplifiers. Refer to "MR-JE-\_B Servo Amplifier Instruction Manual" for the actual connections.

Servo Amplifiers

Servo Motors

Options/Peripheral Equipment

LVS/Wires

Product List

Cautions

## MR-JE-B (SSCNET III/H Interface) Specifications

**B**

Servo amplifier model MR-JE-		10B	20B	40B	70B	100B	200B	300B	
Output	Rated voltage	3-phase 170 V AC							
	Rated current [A]	1.1	1.5	2.8	5.8	6.0	11.0	11.0	
Power supply input	Voltage/frequency <sup>(Note 1)</sup>	3-phase or 1-phase 200 V AC to 240 V AC, 50 Hz/60 Hz				3-phase or 1-phase 200 V AC to 240 V AC, 50 Hz/60 Hz <sup>(Note 8)</sup>		3-phase 200 V AC to 240 V AC, 50 Hz/60 Hz	
	Rated current <sup>(Note 7)</sup> [A]	0.9	1.5	2.6	3.8	5.0	10.5	14.0	
	Permissible voltage fluctuation	3-phase or 1-phase 170 V AC to 264 V AC				3-phase or 1-phase 170 V AC to 264 V AC <sup>(Note 8)</sup>		3-phase 170 V AC to 264 V AC	
	Permissible frequency fluctuation	±5% maximum							
Interface power supply		24 V DC ± 10% (required current capacity: 0.1 A)							
Control method		Sine-wave PWM control/current control method							
Tolerable regenerative power of the built-in regenerative resistor <sup>(Note 2, 3)</sup> [W]		-	-	10	20	20	100	100	
Dynamic brake		Built-in <sup>(Note 4)</sup>							
SSCNET III/H command communication cycle <sup>(Note 6)</sup>		0.444 ms, 0.888 ms							
Communication function		USB: Connect a personal computer (MR Configurator2 compatible)							
Servo function		Advanced vibration suppression control II, adaptive filter II, robust filter, auto tuning, one-touch tuning, tough drive function, drive recorder function, tightening & press-fit function, machine diagnosis function, power monitoring function, lost motion compensation function							
Protective functions		Overcurrent shut-off, regenerative overvoltage shut-off, overload shut-off (electronic thermal), servo motor overheat protection, encoder error protection, regenerative error protection, undervoltage protection, instantaneous power failure protection, overspeed protection, error excessive protection, hotline forced stop function <sup>(Note 9)</sup>							
Compliance to global standards		Refer to "Conformity with global standards and regulations" on p. 19 in this catalog.							
Structure (IP rating)		Natural cooling, open (IP20)					Force cooling, open (IP20)		
Close mounting <sup>(Note 5)</sup>	3-phase power supply input	Possible							
	1-phase power supply input	Possible				Not possible		-	
Environment	Ambient temperature	Operation: 0 °C to 55 °C (non-freezing), storage: -20 °C to 65 °C (non-freezing)							
	Ambient humidity	Operation/Storage: 90 %RH maximum (non-condensing)							
	Ambience	Indoors (no direct sunlight); no corrosive gas, inflammable gas, oil mist or dust							
	Altitude	1000 m or less above sea level							
Vibration resistance		5.9 m/s <sup>2</sup> at 10 Hz to 55 Hz (directions of X, Y and Z axes)							
Mass [kg]		0.8	0.8	0.8	1.5	1.5	2.1	2.1	

Notes: 1. Rated output and speed of a servo motor are applicable when the servo amplifier, combined with the servo motor, is operated within the specified power supply voltage and frequency.

2. Select the most suitable regenerative option for your system with our capacity selection software.

3. Refer to "Regenerative Option" in this catalog for the tolerable regenerative power [W] when regenerative option is used.

4. When using the built-in dynamic brake, refer to "MR-JE-\_B Servo Amplifier Instruction Manual" for the permissible load to motor inertia ratio.

5. When the servo amplifiers are closely mounted, keep the ambient temperature within 0 °C to 45 °C, or use them with 75% or less of the effective load ratio.

6. The command communication cycle depends on the controller specifications and the number of axes connected.

7. This value is applicable when a 3-phase power supply is used.

8. When a 1-phase 200 V AC to 240 V AC power supply is used, use the servo amplifiers with 75% or less of the effective load ratio.

9. When an alarm occurs on MR-JE-B servo amplifier, the hot line forced stop signal will be sent to other servo amplifiers through a controller, and all the servo motors that are operated normally by MR-JE-B servo amplifiers decelerate to a stop. Refer to "MR-JE-\_B Servo Amplifier Instruction Manual" for details.

## MR-JE-B Standard Wiring Diagram Example

B

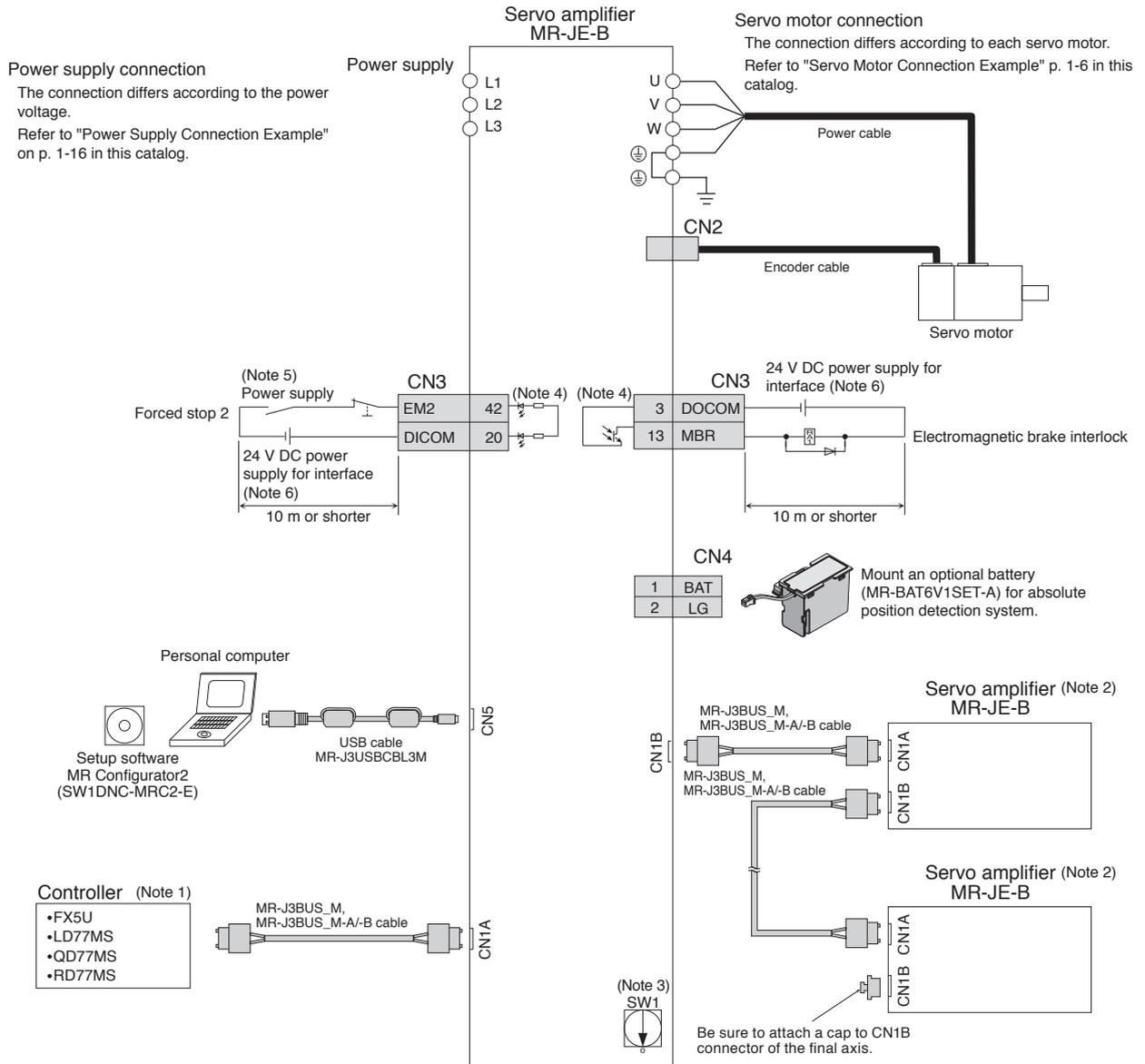

- Notes: 1. For details such as setting the controllers, refer to programming manual or user's manual for the controllers.  
 2. Connections for the second and following axes are omitted.  
 3. Up to 16 axes are set by using an axis selection rotary switch (SW1). Note that the number of the connectable axes depends on the controller specifications. This is for sink wiring. Source wiring is also possible.  
 4. Create a circuit to turn off EM2 (Forced stop 2) when the power is turned off to prevent an unexpected restart of the servo amplifier.  
 5. For convenience of illustration, the diagram shows separate 24 V DC power supplies for input and output signals. However, the input and output signals can share a common power supply.



Be sure to read through Instruction Manual for the actual wiring and use. Use the equipment after you have a full knowledge of the equipment, safety information and instructions.

Servo Amplifiers

Servo Motors

Options/Peripheral Equipment

LVS/Wires

Product List

Cautions

## Power Supply Connection Example (MR-JE-B)

B

● For 1-phase 200 V AC, 1 kW or smaller

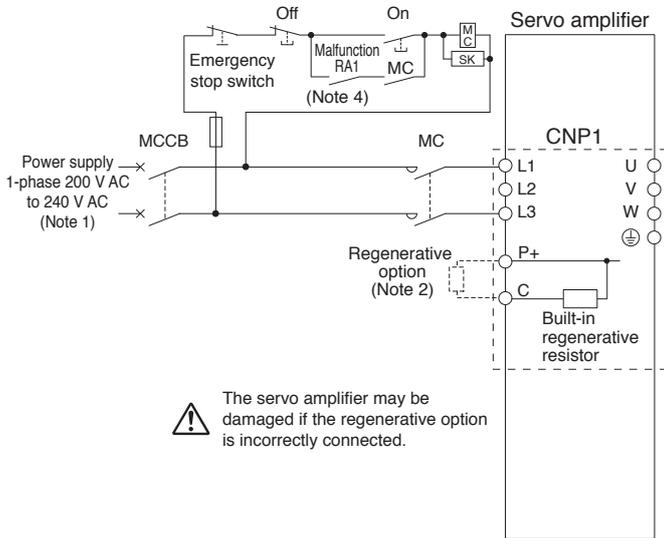

● For 3-phase 200 V AC, 1 kW or smaller

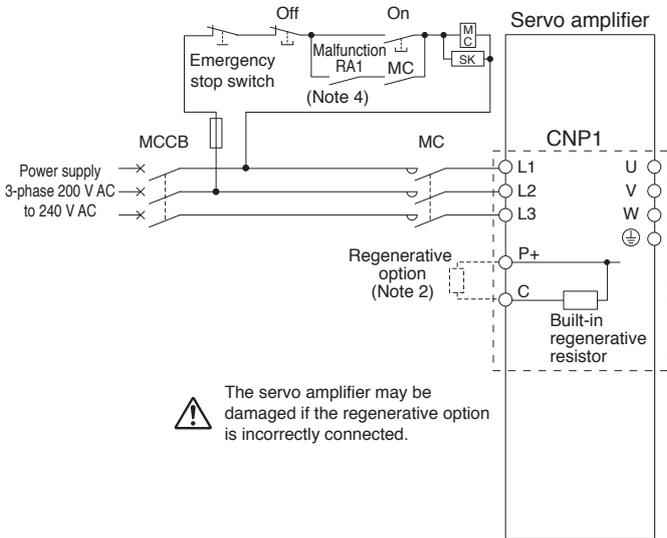

● For 1-phase 200 V AC, 2 kW

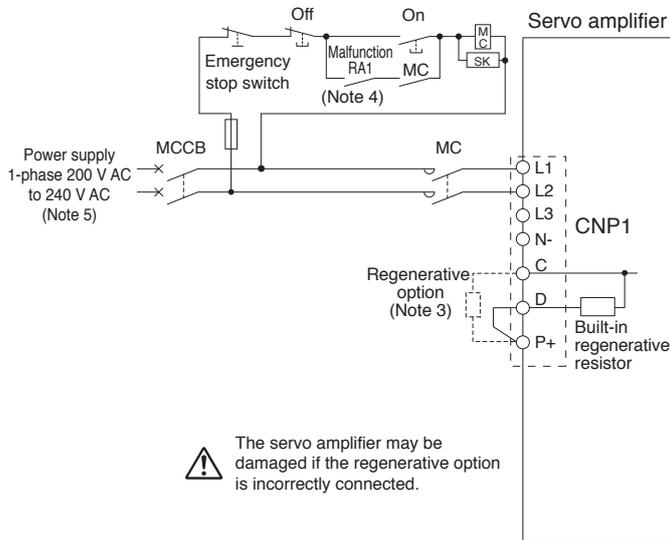

● For 3-phase 200 V AC, 2 kW and 3 kW

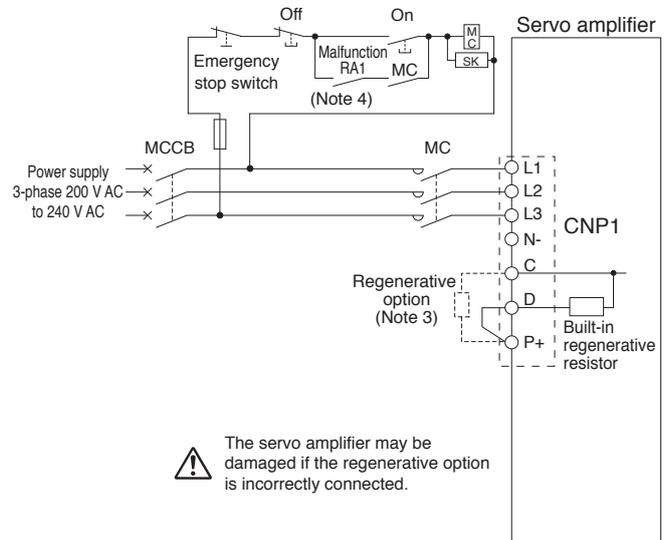

- Notes: 1. For 1-phase 200 V AC to 240 V AC, connect the power supply to L1 and L3 terminals. Do not connect anything to L2.  
 2. Disconnect the wires for the built-in regenerative resistor (P+ and C), and remove the resistor when connecting the regenerative option externally.  
 3. Disconnect a short-circuit bar between P+ and D when connecting the regenerative option externally.  
 4. Create a power circuit to turn off the magnetic contactors of all the servo amplifiers after an alarm is detected on controller side.  
 5. For 1-phase 200 V AC to 240 V AC, connect the power supply to L1 and L2 terminals. Do not connect anything to L3.



Be sure to read through Instruction Manual for the actual wiring and use. Use the equipment after you have a full knowledge of the equipment, safety information and instructions.

## Servo Motor Connection Example

B A

### ● For HG-KN series

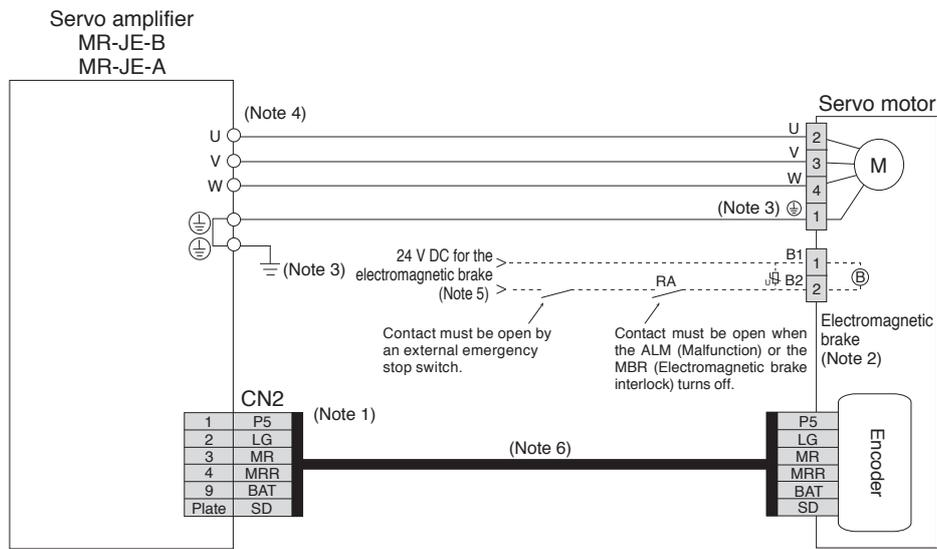

### ● For HG-SN series

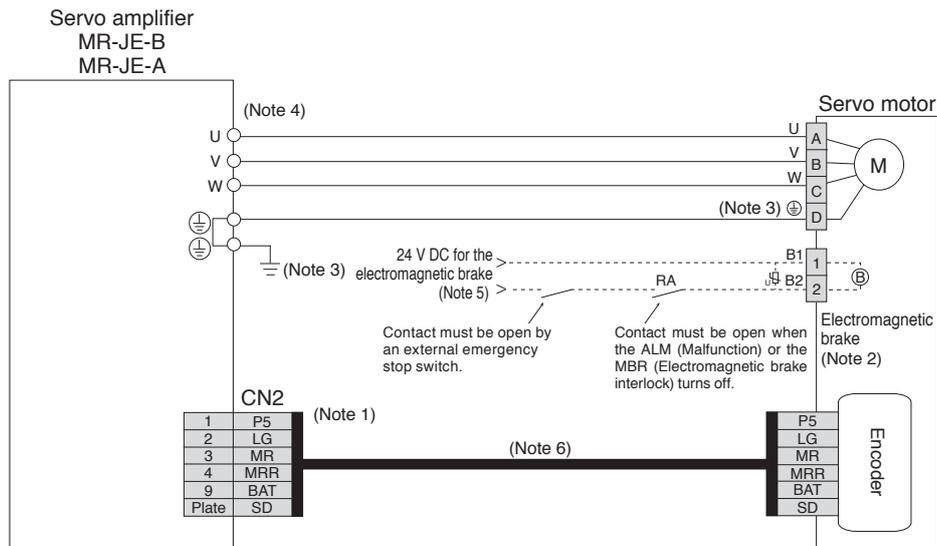

- Notes: 1. The signals shown is applicable when using a two-wire type encoder cable. Four-wire type is also compatible.  
 2. This is for the servo motor with electromagnetic brake. The electromagnetic brake terminals (B1, B2) do not have polarity.  
 3. For 1 kW or smaller servo amplifiers, connect the grounding terminal of the servo motor to ⊕ of CNP1, and connect the protective earth (PE) terminal (⊕) located on the lower front of the servo amplifier to the cabinet protective earth (PE).  
 For 2 kW or larger servo amplifiers, connect the grounding terminal of the servo motor to the protective earth (PE) terminal (⊕) located on the lower front of the servo amplifier, and connect the other protective earth (PE) terminal (⊕) to the cabinet protective earth (PE).  
 4. The connector varies depending on the servo amplifier capacities. Refer to the dimensions of the relevant servo amplifier in this catalog for details.  
 5. Do not use the 24 V DC interface power supply for the electromagnetic brake. Provide a dedicated power supply to the electromagnetic brake.  
 6. Encoder cable is available as an option. Refer to "HG-KN HG-SN Servo Motor Instruction Manual" when fabricating the cables.



Be sure to read through Instruction Manual for the actual wiring and use. Use the equipment after you have a full knowledge of the equipment, safety information and instructions.

## MR-JE-B Dimensions

- MR-JE-10B (Note 1)
- MR-JE-20B (Note 1)
- MR-JE-40B (Note 1)

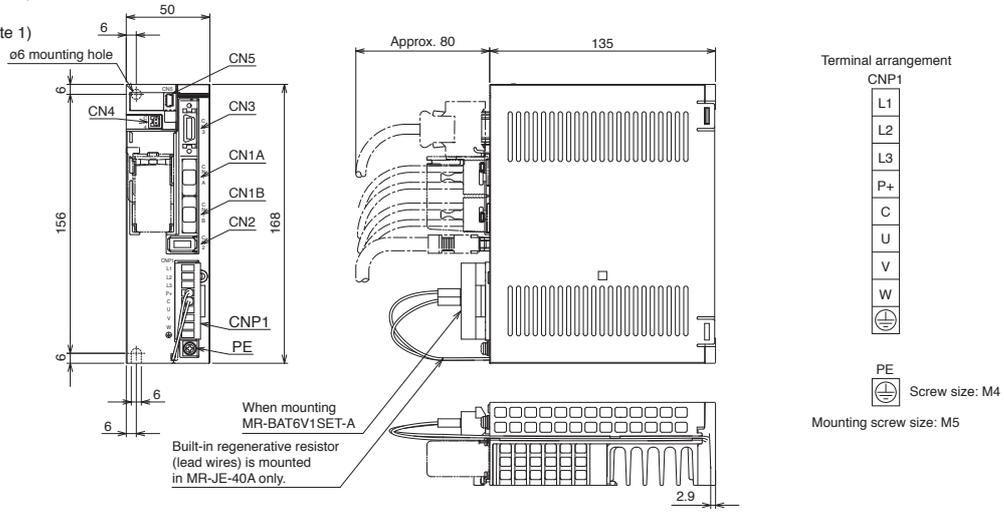

- MR-JE-70B (Note 1)
- MR-JE-100B (Note 1)

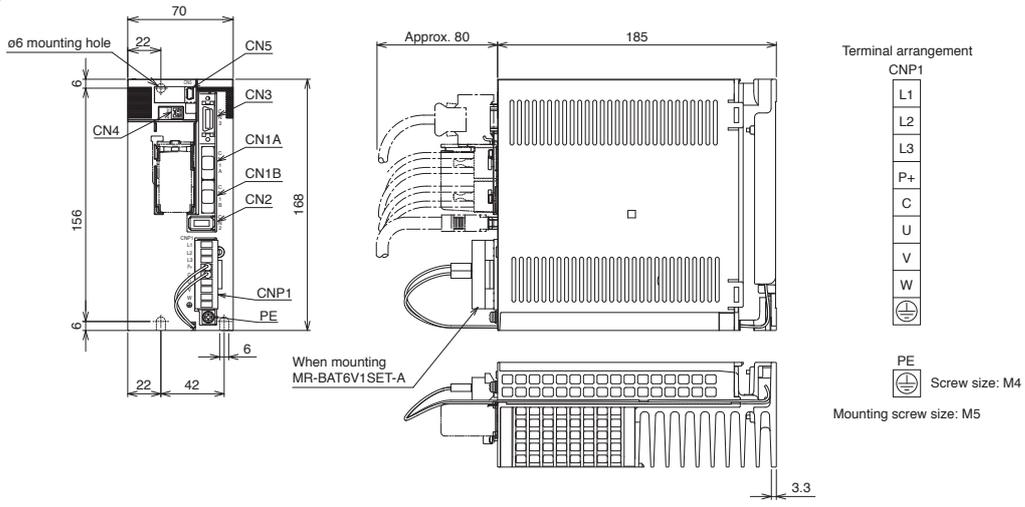

- MR-JE-200B (Note 2)
- MR-JE-300B (Note 2)

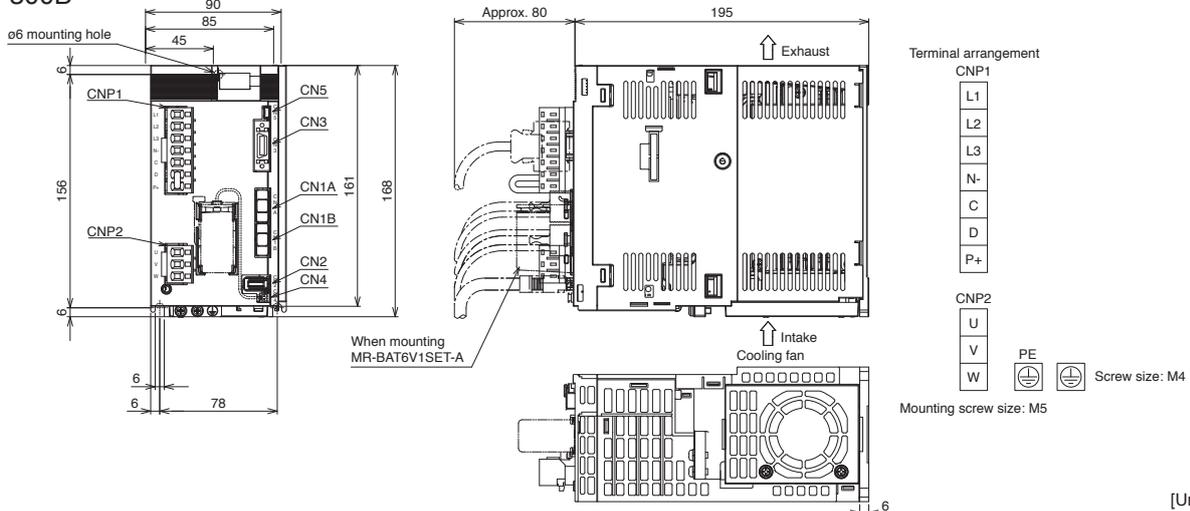

Notes: 1. CNP1 connector (insertion type) is supplied with the servo amplifier.  
2. CNP1 and CNP2 connectors (insertion type) are supplied with the servo amplifier.

## MR-JE-A Connections with Peripheral Equipment (Note 1)

A

Peripheral equipment is connected to MR-JE-A as described below. Connectors, cables, options, and other necessary equipment are available so that users can set up the servo amplifier easily and start using it right away.

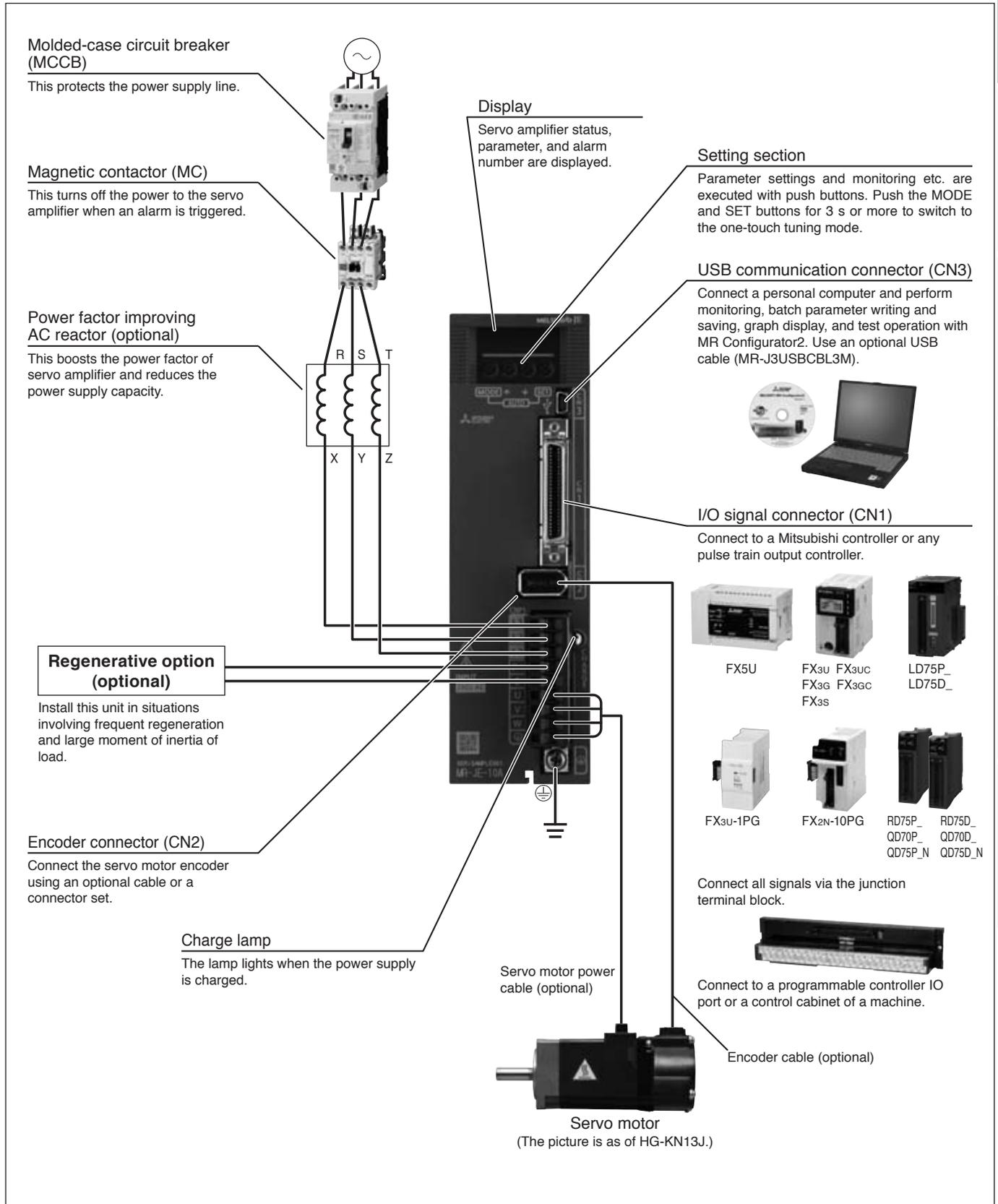

Notes: 1. The connection with the peripheral equipment is an example for MR-JE-100A or smaller servo amplifiers. Refer to "MR-JE-\_A Servo Amplifier Instruction Manual" for the actual connections.

## MR-JE-A (General-purpose Interface) Specifications

A

Servo amplifier model MR-JE-		10A	20A	40A	70A	100A	200A	300A	
Output	Rated voltage	3-phase 170 V AC							
	Rated current [A]	1.1	1.5	2.8	5.8	6.0	11.0	11.0	
Power supply input	Voltage/frequency (Note 1)	3-phase or 1-phase 200 V AC to 240 V AC, 50 Hz/60 Hz				3-phase or 1-phase 200 V AC to 240 V AC, 50 Hz/60 Hz (Note 9)		3-phase 200 V AC to 240 V AC, 50 Hz/60 Hz	
	Rated current (Note 7) [A]	0.9	1.5	2.6	3.8	5.0	10.5	14.0	
	Permissible voltage fluctuation	3-phase or 1-phase 170 V AC to 264 V AC				3-phase or 1-phase 170 V AC to 264 V AC (Note 9)		3-phase 170 V AC to 264 V AC	
	Permissible frequency fluctuation	±5% maximum							
Interface power supply		24 V DC ± 10% (required current capacity: 0.3 A)							
Control method		Sine-wave PWM control/current control method							
Tolerable regenerative power of the built-in regenerative resistor (Note 2, 3) [W]		-	-	10	20	20	100	100	
Dynamic brake		Built-in (Note 4, 8)							
Communication function		USB: Connect a personal computer (MR Configurator2 compatible) RS-422/RS-485 (Note 10): Connect a controller (1 : n communication up to 32 axes) (Note 6)							
Encoder output pulse		Compatible (A/B/Z-phase pulse)							
Analog monitor		2 channels							
Position control mode	Maximum input pulse frequency	4 Mpulses/s (when using differential receiver), 200 kpulses/s (when using open-collector)							
	Positioning feedback pulse	Encoder resolution: 131072 pulses/rev							
	Command pulse multiplying factor	Electronic gear A/B multiple, A: 1 to 16777215, B: 1 to 16777215, 1/10 < A/B < 4000							
	Positioning complete width setting	0 pulse to ±65535 pulses (command pulse unit)							
	Error excessive	±3 rotations							
	Torque limit	Set by parameters or external analog input (0 V DC to +10 V DC/maximum torque)							
Speed control mode	Speed control range	Analog speed command 1:2000, internal speed command 1:5000							
	Analog speed command input	0 V DC to ±10 V DC/rated speed (Speed at 10 V is changeable with [Pr. PC12].)							
	Speed fluctuation rate	±0.01% maximum (load fluctuation 0% to 100%), 0% (power fluctuation: ±10%) ±0.2% maximum (ambient temperature: 25 °C ± 10 °C) only when using analog speed command							
	Torque limit	Set by parameters or external analog input (0 V DC to +10 V DC/maximum torque)							
Torque control mode	Analog torque command input	0 V DC to ±8 V DC/maximum torque (input impedance: 10 kΩ to 12 kΩ)							
	Speed limit	Set by parameters or external analog input (0 V DC to ± 10 V DC/rated speed)							
Positioning mode		Point table method, program method							
Servo function		Advanced vibration suppression control II, adaptive filter II, robust filter, auto tuning, one-touch tuning, tough drive function, drive recorder function, machine diagnosis function, power monitoring function							
Protective functions		Overcurrent shut-off, regenerative overvoltage shut-off, overload shut-off (electronic thermal), servo motor overheat protection, encoder error protection, regenerative error protection, undervoltage protection, instantaneous power failure protection, overspeed protection, error excessive protection							
Compliance to global standards		Refer to "Conformity with global standards and regulations" on p. 19 in this catalog.							
Structure (IP rating)		Natural cooling, open (IP20)					Force cooling, open (IP20)		
Close mounting (Note 5)	3-phase power supply input	Possible							
	1-phase power supply input	Possible				Not possible		-	
Environment	Ambient temperature	Operation: 0 °C to 55 °C (non-freezing), storage: -20 °C to 65 °C (non-freezing)							
	Ambient humidity	Operation/Storage: 90 %RH maximum (non-condensing)							
	Ambience	Indoors (no direct sunlight); no corrosive gas, inflammable gas, oil mist or dust							
	Altitude	1000 m or less above sea level							
Vibration resistance		5.9 m/s <sup>2</sup> at 10 Hz to 55 Hz (directions of X, Y and Z axes)							
Mass [kg]		0.8	0.8	0.8	1.5	1.5	2.1	2.1	

Notes: 1. Rated output and speed of a servo motor are applicable when the servo amplifier, combined with the servo motor, is operated within the specified power supply voltage and frequency.

2. Select the most suitable regenerative option for your system with our capacity selection software.

3. Refer to "Regenerative Option" in this catalog for the tolerable regenerative power [W] when regenerative option is used.

4. When using the built-in dynamic brake, refer to "MR-JE-\_A Servo Amplifier Instruction Manual" for the permissible load to motor inertia ratio.

5. When the servo amplifiers are closely mounted, keep the ambient temperature within 0 °C to 45 °C, or use them with 75% or less of the effective load ratio.

6. RS-422 communication function is available with the servo amplifiers manufactured on December 2013 or later. RS-485 communication function is available with the servo amplifiers manufactured on May 2015 or later. Refer to "MR-JE-\_A Servo Amplifier Instruction Manual" for how to verify the manufacturing date of the products.

7. This value is applicable when a 3-phase power supply is used.

8. The coast distance by dynamic brake of HG-KN/HG-SN servo motor series may be different from prior HF-KN/HF-SN. Contact your local sales office for more details.

9. When 1-phase 200 V AC to 240 V AC power supply is used, use them with 75% or less of the effective load ratio.

10. Compatible with Mitsubishi general-purpose AC servo protocol (RS-422/RS-485 communication) and MODBUS® RTU protocol (RS-485 communication).





MR-JE-A Standard Wiring Diagram Example: Position Control Operation

A

Connecting to QD75D/LD75D/RD75D (position servo, incremental)

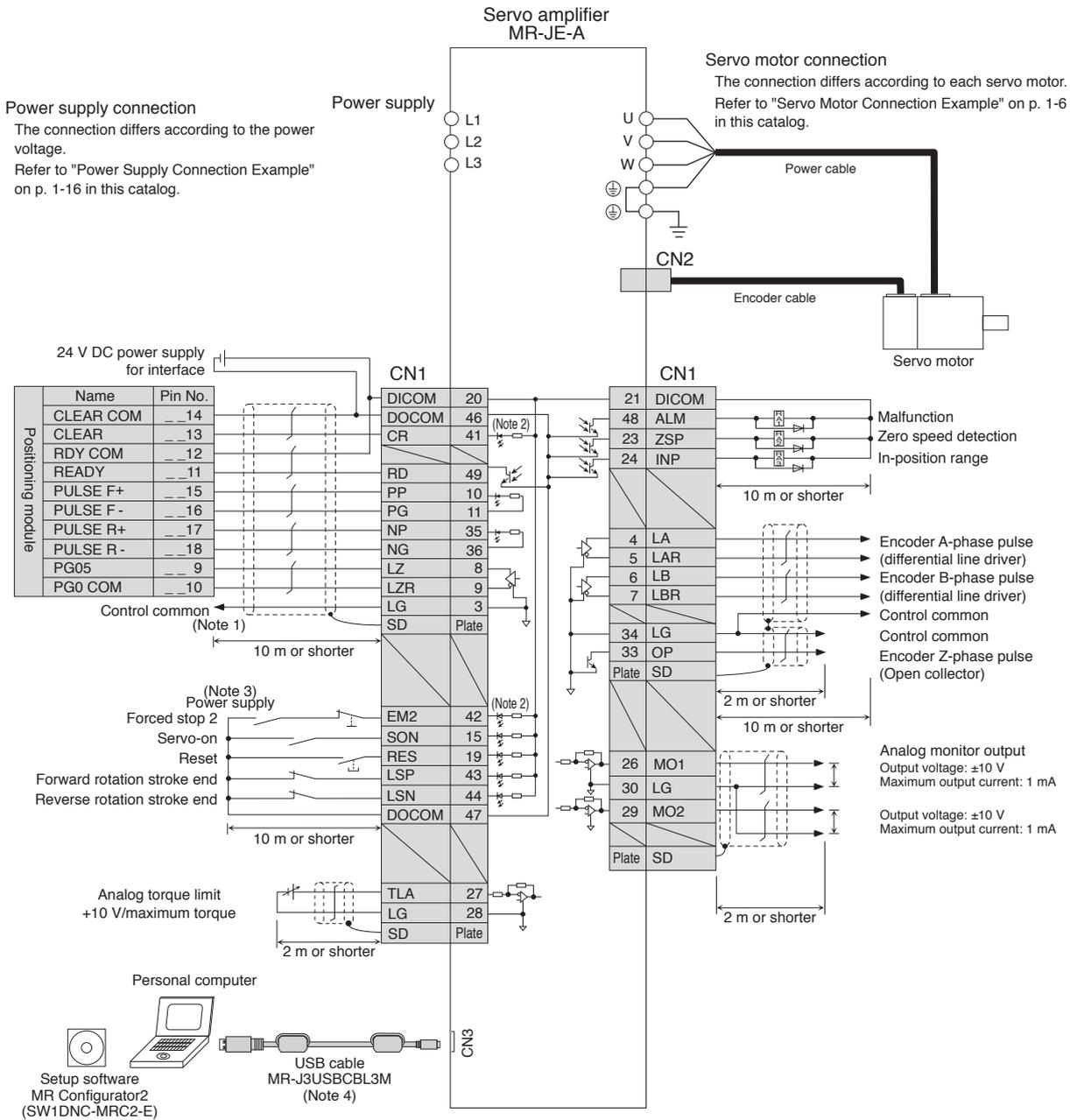

- Notes: 1. This connection is not necessary for QD75D/LD75D/RD75D Positioning module. Note that the connection between LG and control common terminal is recommended for some Positioning modules to improve noise tolerance.  
 2. This is for sink wiring. Source wiring is also possible.  
 3. Create a circuit to turn off EM2 (Forced stop 2) when the power is turned off to prevent an unexpected restart of the servo amplifier.  
 4. USB interface, RS-422 interface, and RS-485 interface are mutually exclusive. Do not use them at the same time.



Be sure to read through Instruction Manual for the actual wiring and use. Use the equipment after you have a full knowledge of the equipment, safety information and instructions.

# MR-JE-A Standard Wiring Diagram Example: Speed Control Operation

A

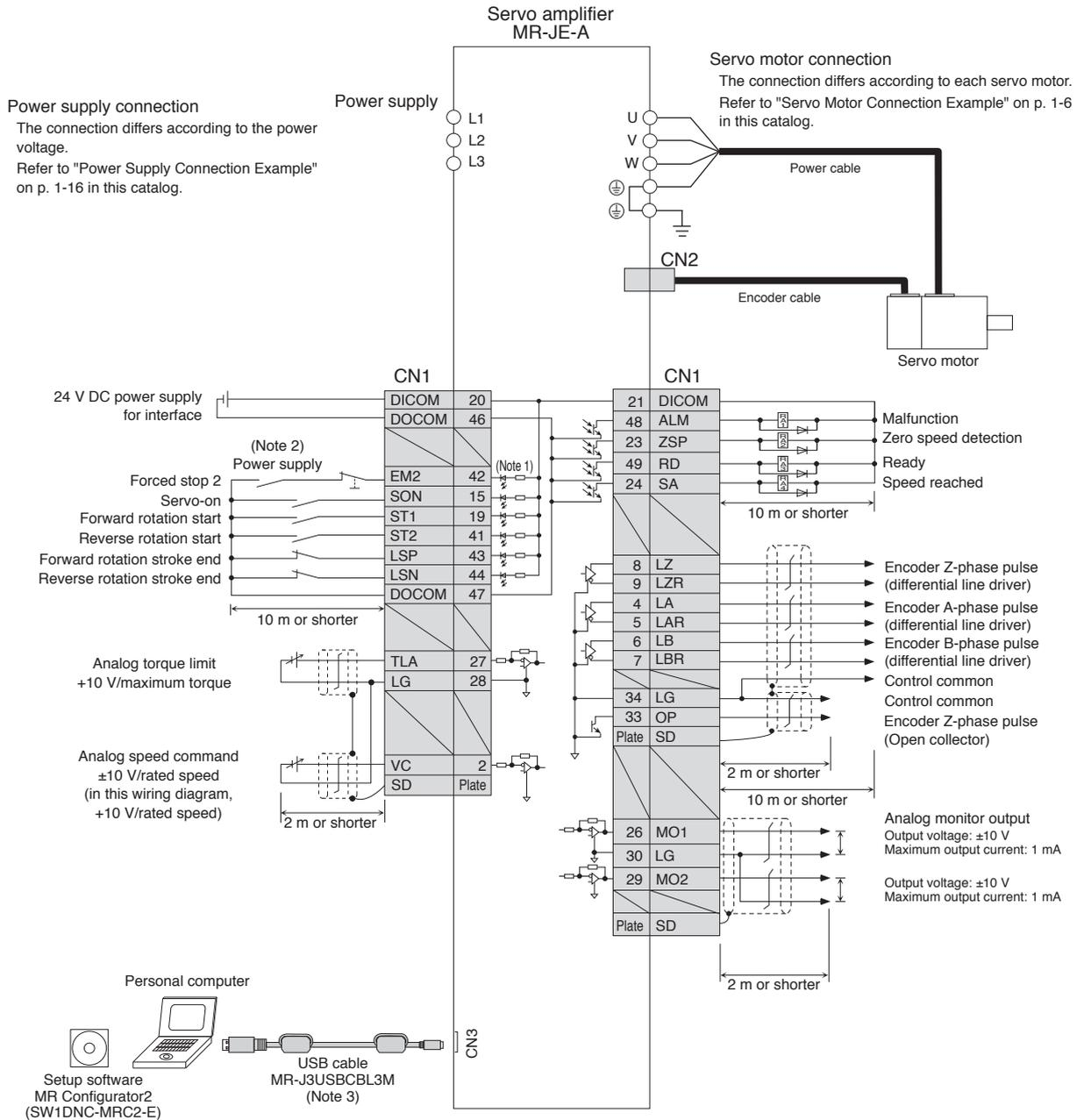

- Notes: 1. This is for sink wiring. Source wiring is also possible.  
 2. Create a circuit to turn off EM2 (Forced stop 2) when the power is turned off to prevent an unexpected restart of the servo amplifier.  
 3. USB interface, RS-422 interface, and RS-485 interface are mutually exclusive. Do not use them at the same time.

**!** Be sure to read through Instruction Manual for the actual wiring and use. Use the equipment after you have a full knowledge of the equipment, safety information and instructions.

Servo Amplifiers  
 Servo Motors  
 Options/Peripheral Equipment  
 LVS/Wires  
 Product List  
 Cautions

## MR-JE-A Standard Wiring Diagram Example: Torque Control Operation

A

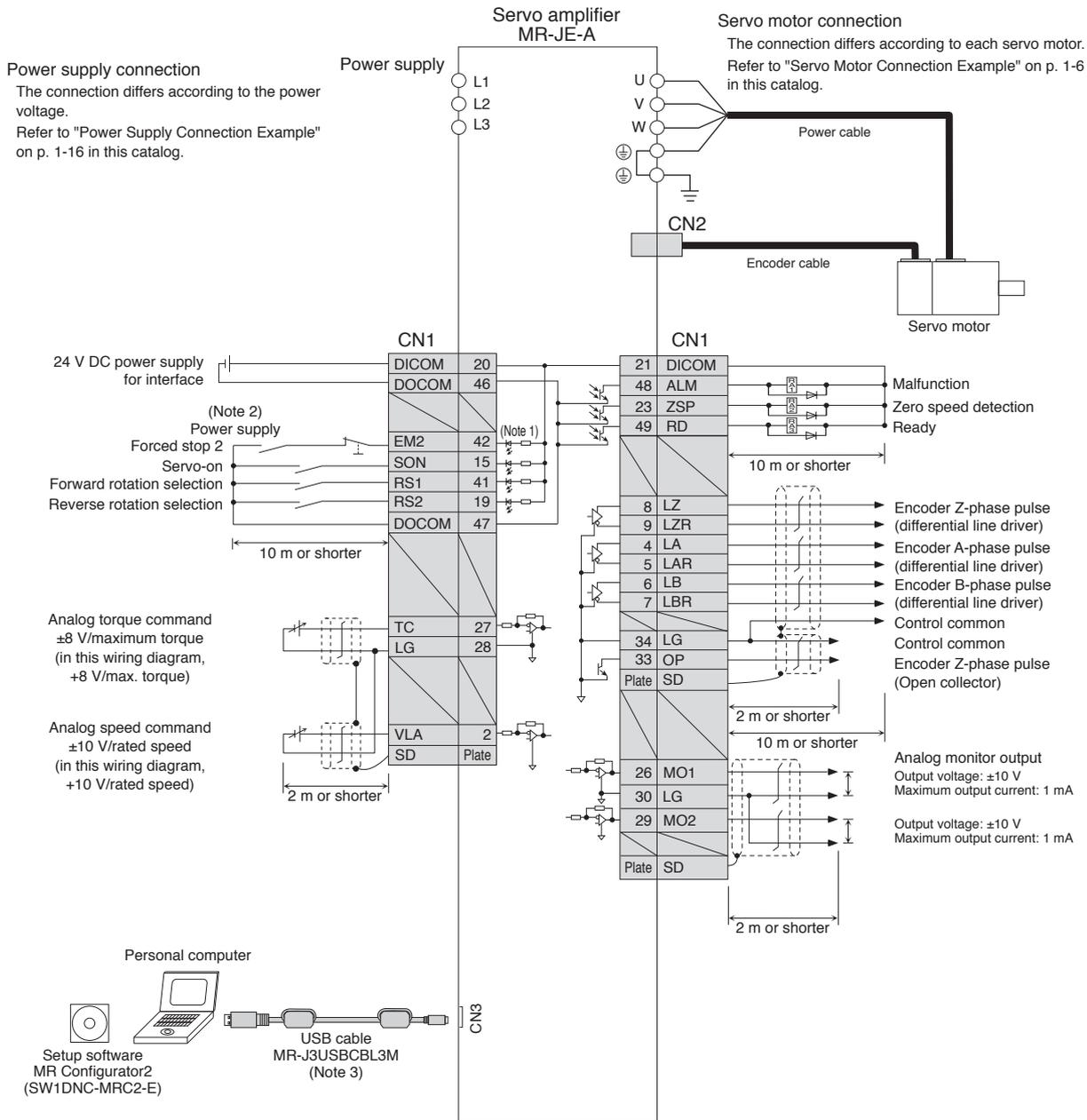

- Notes: 1. This is for sink wiring. Source wiring is also possible.  
2. Create a circuit to turn off EM2 (Forced stop 2) when the power is turned off to prevent an unexpected restart of the servo amplifier.  
3. USB interface, RS-422 interface, and RS-485 interface are mutually exclusive. Do not use them at the same time.



Be sure to read through Instruction Manual for the actual wiring and use. Use the equipment after you have a full knowledge of the equipment, safety information and instructions.

## RS-422 Serial Communication Connection Example

A

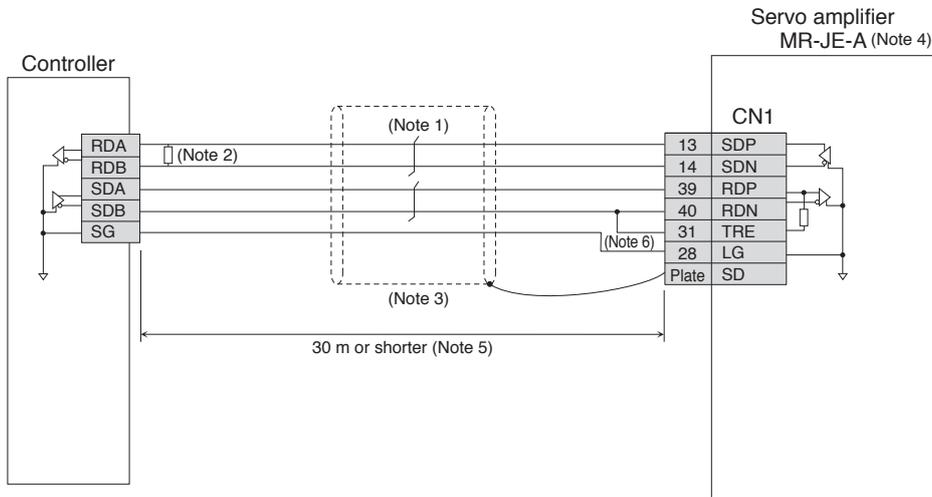

Servo Amplifiers

Servo Motors

Options/Peripheral Equipment

LVS/Wires

Product List

Cautions

## RS-485 Serial Communication Connection Example

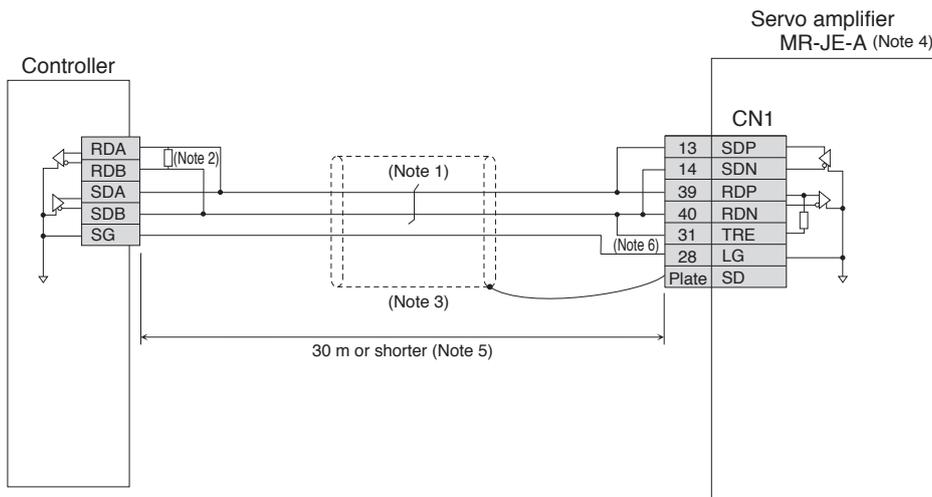

Notes: 1. Twist the wires from SDP and SDN together, and RDP and PDN together.

2. Refer to the controller manual to connect a termination resistor. If a termination resistor is not specified, terminate with a 150 Ω resistor.

3. It is recommended that the cable be shielded.

4. RS-422 communication function is available with the servo amplifiers manufactured on December 2013 or later. RS-485 communication function is available with the servo amplifiers manufactured on May 2015 or later. Refer to "MR-JE\_A Servo Amplifier Instruction Manual" for how to identify the manufacturing date of the products.

5. The cable length must be 30 m or shorter in a low-noise environment. When connecting multiple axes, also keep the overall length within 30 m.

6. Connect TRE and RDN for the servo amplifier of the final axis.



Be sure to read through Instruction Manual for the actual wiring and use. Use the equipment after you have a full knowledge of the equipment, safety information and instructions.

## MODBUS® RTU Specifications

Item	Specifications	
Communication protocol	MODBUS® RTU protocol	
Compliance to standards	EIA-485 (RS-485)	
Numbers connected	1: n (Maximum 32) Set stations 1 to 247 by a parameter. (Station 0 is for broadcast communication)	
Communication baud rate [bps]	4800/9600/19200/38400/57600/115200 (set by a parameter)	
Control process	Asynchronous system	
Communication method	Half-duplex method	
Maximum overall extension distance [m]	30	
Communication specifications	Character method	Binary (8-bit fixed)
	Start bit	1-bit
	Stop bit length	Select from the following by a parameter. • Even parity, stop bit length 1-bit (initial value) • Odd parity, stop bit length 1-bit • No parity, stop bit length 2-bit
	Parity check	
	Error check	CRC-16 method
	Terminator	None
Waiting time setting	None	
Master/Slave classification	Slave	

## MODBUS® RTU Wiring (For Multi-drop)

Up to 32 servo amplifier axes can be operated on the same bus.

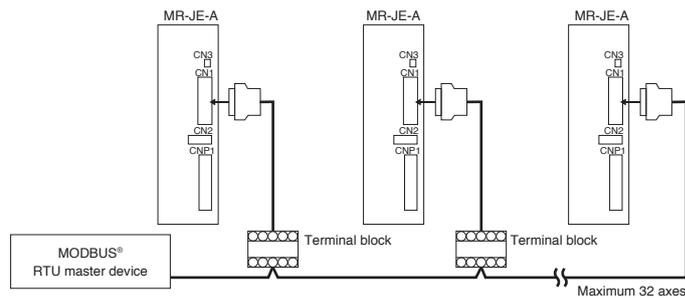

## MODBUS® RTU Compatible Function Codes

MR-JE-A servo amplifier is compatible with following function code.

Code	Function name	Description
03h	Read holding registers	Reading holding registers Reads data stored in holding registers from a master.
08h	Diagnostics	Functional diagnostics When this function code is sent from a master to slaves, the slaves return the data as it is. This function can be used for checking the communication status.
10h	Preset multiple registers	Writing to multiple registers Writes a series of data to multiple holding registers from a master.

## MODBUS® RTU Functions

The functions of MODBUS® RTU are as follows. MODBUS® RTU can operate and maintain the servo amplifier by remote control.

Function	Description
Status monitor	Reads the items of "Display All" in monitor function of MR Configurator 2 such as servo motor speed and droop pulse.
Parameter setting	Reads and writes parameters.
Point table setting	Reads and writes point table data.
Current alarm reading	Reads an alarm No. currently generated.
Alarm history reading	Reads all 16 alarm histories.
Parameter error No. reading/point table error No. reading	Reads corresponding parameter No. for parameter error and corresponding point table No. for point table error.
Input/output monitor	Reads on/off status of I/O signal and monitor situation of I/O device.
Motor driving	Drives servo motors.
Servo amplifier information reading	Reads servo amplifier model, software version, and cumulative power time.

## Power Supply Connection Example (MR-JE-A)

● For 1-phase 200 V AC, 1 kW or smaller

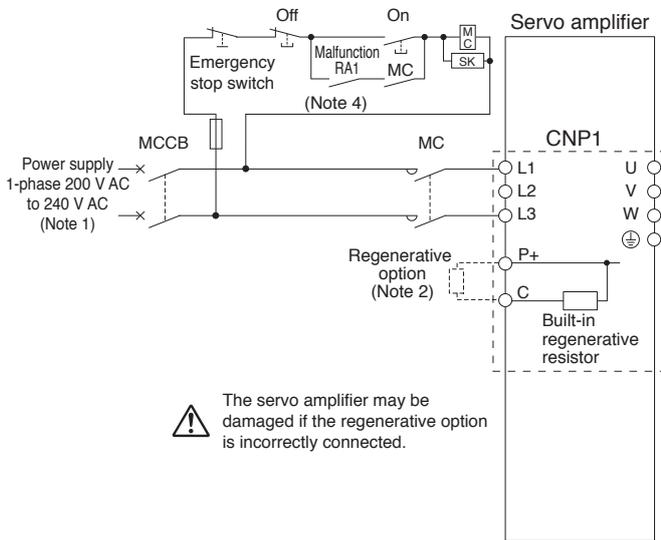

● For 3-phase 200 V AC, 1 kW or smaller

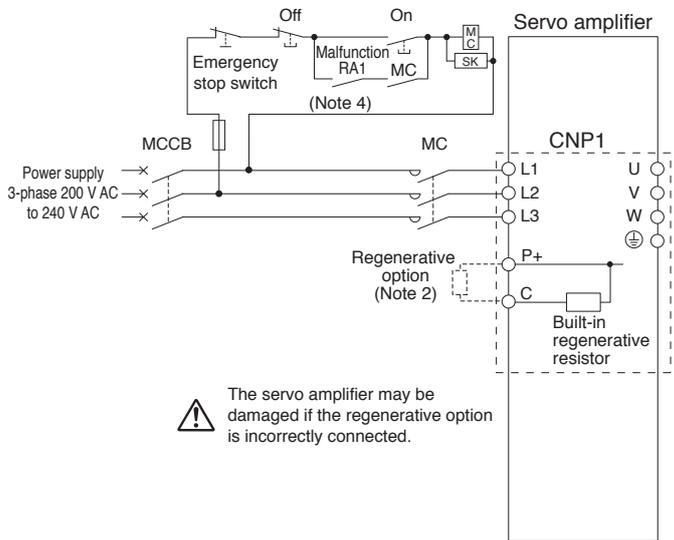

● For 1-phase 200 V AC, 2 kW

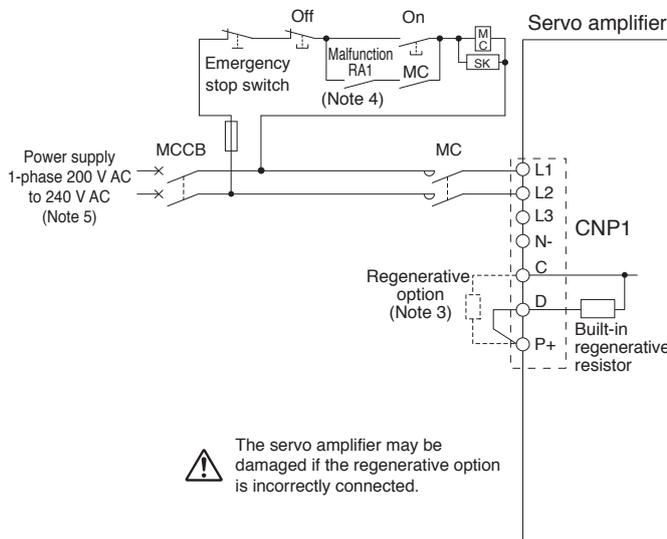

● For 3-phase 200 V AC, 2 kW and 3 kW

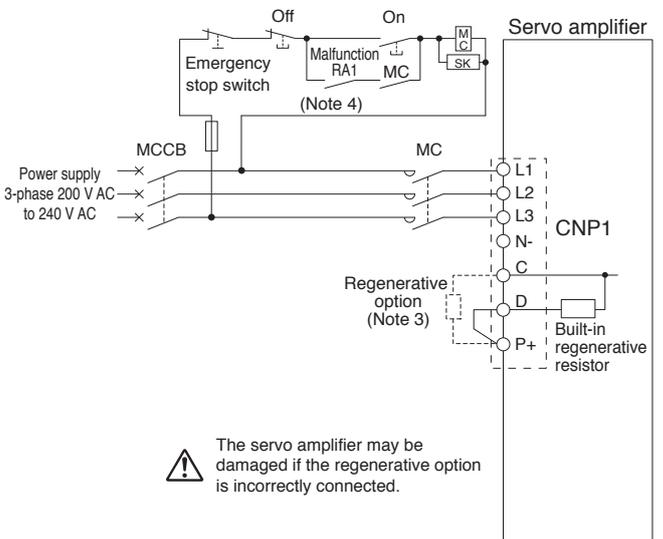

- Notes: 1. For 1-phase 200 V AC to 240 V AC, connect the power supply to L1 and L3 terminals. Do not connect anything to L2. The connections are different from MR-E Super series servo amplifiers. Be careful not to make a connection error when replacing MR-E Super with MR-JE.  
 2. Disconnect the wires for the built-in regenerative resistor (P+ and C), and remove the resistor when connecting the regenerative option externally.  
 3. Disconnect a short-circuit bar between P+ and D when connecting the regenerative option externally.  
 4. Create a power circuit to turn off the magnetic contactor when ALM (malfunction) is off (alarm occurrence).  
 5. For 1-phase 200 V AC to 240 V AC, connect the power supply to L1 and L2 terminals. Do not connect anything to L3.



Be sure to read through Instruction Manual for the actual wiring and use. Use the equipment after you have a full knowledge of the equipment, safety information and instructions.

## MR-JE-A Positioning Function: Point Table Method

A

Positioning operation is executed by selecting the point table No. with a command interface signal according to the position and speed data set in the point table.

Item		Description	
Command method	Command interface	Input: 7 points excluding EM2 (Forced stop 2), output: 3 points excluding ALM (Malfunction), RS-422 communication/RS-485 communication (Note 2)	
	Operating specification	Positioning by specifying the point table No. (31 points when communication is specified, 15 points when DI is used)	
	Position command input (Note 1)	Absolute value command method	Set in the point table. Setting range of feed length per point: -999999 to 999999 [ $\times 10^{\text{STM}}$ $\mu\text{m}$ ], -99.9999 to 99.9999 [ $\times 10^{\text{STM}}$ inch], -999999 to 999999 [pulse], Setting range of rotation angle: -360.000 to 360.000 [degree]
		Incremental value command method	Set in the point table. Setting range of feed length per point: 0 to 999999 [ $\times 10^{\text{STM}}$ $\mu\text{m}$ ], 0 to 99.9999 [ $\times 10^{\text{STM}}$ inch], 0 to 999999 [pulse], Setting range of rotation angle: 0 to 999.999 [degree]
	Speed command input	Set the acceleration/deceleration time constants in the point table. Set the S-pattern acceleration/deceleration time constants with [Pr. PC03].	
	System	Signed absolute value command method, incremental value command method	
	Analog override	0 V DC to $\pm 10$ V DC/0% to 200%	
	Torque limit	Set by parameters or external analog input (0 V DC to +10 V DC/maximum torque)	
Operation mode	Automatic operation mode	Each positioning operation	Point table No. input, position data input method Each positioning operation is executed based on the position/speed commands.
		Automatic continuous positioning operation	Varying-speed operation (2 to 31 speeds), automatic continuous positioning operation (2 to 31 points)
	Manual operation mode	JOG operation	Inching operation is executed with DI or serial communication function (Note 2) according to the speed command set with a parameter.
		Manual pulse generator operation	Manual feeding is executed with a manual pulse generator. Command pulse multiplication: select from $\times 1$ , $\times 10$ , and $\times 100$ with a parameter.
	Home position return mode	Dog type	Returns to home position upon Z-phase pulse after passing through proximity dog. Home position return direction selectable, home position shift distance settable, home position address settable, automatic retract on dog back to home position, automatic stroke retract function
		Count type	Returns to home position upon the encoder pulse count after touching proximity dog. Home position return direction selectable, home position shift distance settable, home position address settable, automatic retract on dog back to home position, automatic stroke retract function
		Data set type	Returns to home position without dog. Any position settable as a home position using manual operation, etc. Home position address settable
		Stopper type	Returns to home position upon hitting the stroke end. Home position return direction selectable, home position address settable
		Home position ignorance (servo-on position as home position)	Sets a home position where SON (Servo-on) signal turns on. Home position address settable
		Dog type rear end reference	Returns to home position with reference to the rear end of proximity dog. Home position return direction selectable, home position shift distance settable, home position address settable, automatic retract on dog back to home position, automatic stroke retract function
		Count type front end reference	Returns to home position with reference to the front end of proximity dog. Home position return direction selectable, home position shift distance settable, home position address settable, automatic retract on dog back to home position, automatic stroke retract function
		Dog cradle type	Returns to home position upon the first Z-phase pulse with reference to the front end of proximity dog. Home position return direction selectable, home position shift distance settable, home position address settable, automatic retract on dog back to home position, automatic stroke retract function
		Dog type adjacent Z-phase reference	Returns to home position upon the last Z-phase pulse with reference to the front end of proximity dog. Home position return direction selectable, home position shift distance settable, home position address settable, automatic retract on dog back to home position, automatic stroke retract function
		Dog type front end reference	Returns to home position to the front end of dog with reference to the front end of proximity dog. Home position return direction selectable, home position shift distance settable, home position address settable, automatic retract on dog back to home position, automatic stroke retract function
	Dogless Z-phase reference	Returns to home position to Z-phase pulse with reference to the first Z-phase pulse. Home position return direction selectable, home position shift distance settable, home position address settable	
Automatic positioning to home position function	High-speed automatic positioning to a defined home position		
Other functions	Backlash compensation, overtravel prevention with external limit switches (LSP/LSN), teaching function, roll feed display function, software stroke limit, mark detection (current position latch/interrupt positioning/mark sensor input compensation), simple cam function, encoder following function, command pulse input through function, analog override function		

Notes: 1. STM is the ratio to the setting value of the position data. STM can be changed with [Pr. PT03].

2. Compatible with Mitsubishi general-purpose AC servo protocol (RS-422/RS-485 communication) and MODBUS<sup>®</sup> RTU protocol (RS-485 communication).



## MR-JE-A Positioning Function: Point Table Method

A

Absolute value command method: travels to a specified address (absolute value) with reference to the home position

Item	Setting range	Description
Point table No.	1 to 31 (when communication is specified) 1 to 15 (when DI is used)	Specify a point table in which a target position, servo motor speed, acceleration/deceleration time constants, dwell, and sub function will be set.
Target position <sup>(Note 1, 2)</sup> (position data)	-999999 to 999999 [ $\times 10^{\text{STM}}$ $\mu\text{m}$ ] -99.9999 to 99.9999 [ $\times 10^{\text{STM}}$ inch] -360.000 to 360.000 [degree] -999999 to 999999 [pulse]	Set a travel distance. (1) When using as absolute value command method Set a target address (absolute value). (2) When using as incremental value command method Set a travel distance. Reverse rotation command is applied with a minus sign.
Servo motor speed	0 to permissible speed [r/min]	Set a command speed for the servo motor in positioning.
Acceleration time constant	0 to 20000 [ms]	Set a time period for the servo motor to reach the rated speed.
Deceleration time constant	0 to 20000 [ms]	Set a time period for the servo motor to decelerate from the rated speed to a stop.
Dwell	0 to 20000 [ms]	Set dwell. When the dwell is set, the position command for the next point table will be started after the position command for the selected point table is completed and the set dwell is passed. The dwell is disabled when 0 or 2 is set for the sub function. Varying-speed operation is enabled when 1, 3, 8, 9, 10, or 11 is set for the sub function and when 0 is set for the dwell.
Sub function	0 to 3, and 8 to 11	Set sub function. (1) When using as absolute value command method 0: Executes automatic operation for a selected point table. 1: Executes automatic continuous operation without stopping for the next point table. 8: Executes automatic continuous operation without stopping for the point table selected at the start. 9: Executes automatic continuous operation without stopping for the point table No. 1. (2) When using as incremental value command method 2: Executes automatic operation for a selected point table. 3: Executes automatic continuous operation without stopping for the next point table. 10: Executes automatic continuous operation without stopping for the point table selected at the start. 11: Executes automatic continuous operation without stopping for the point table No. 1.
M code	0 to 99	Set a code to be outputted when the positioning completes.

Notes: 1. Change the unit to  $\mu\text{m}$ /inch/degree/pulse with [Pr. PT01].

2. STM is the ratio to the setting value of the position data. STM can be changed with [Pr. PT03].

### Example of setting point table data

Point table No.	Target position (position data) [ $\times 10^{\text{STM}}$ $\mu\text{m}$ ] <small>(Note 1)</small>	Servo motor speed [r/min]	Acceleration time constant [ms]	Deceleration time constant [ms]	Dwell [ms]	Sub function	M code
1	1000	2000	200	200	0	*	1
2	2000	1600	100	100	0	0	2
:	:	:	:	:	:	:	:
31	3000	3000	100	100	0	2	99

\* The operation of the next point table is set with the sub function.

● When the sub function is set to 0:

Start signal is required for each point table.

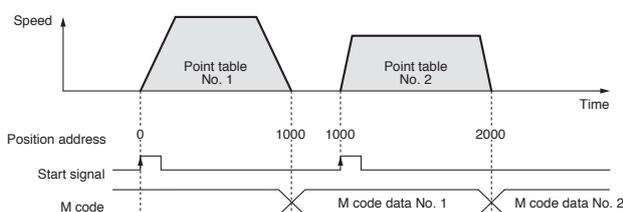

● When the sub function is set to 1:

Automatic continuous operation is executed based on the point table.

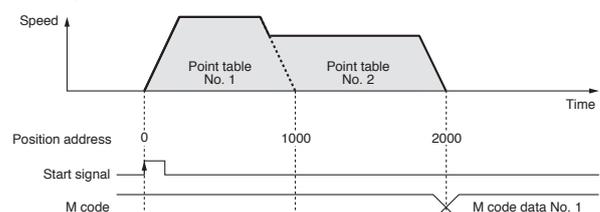

Notes: 1. STM is the ratio to the setting value of the position data. STM can be changed with [Pr. PT03].

Servo Amplifiers

Servo Motors

Options/Peripheral Equipment

LVS/Wires

Product List

Cautions

## MR-JE-A Positioning Function: Point Table Method

A

Incremental value command method: travels from a current position according to the set position data

Item	Setting range	Description
Point table No.	1 to 31 (when communication is specified) 1 to 15 (when DI is used)	Specify a point table in which a target position, servo motor speed, acceleration/deceleration time constants, dwell, and sub function will be set.
Target position (Note 1, 2) (position data)	0 to 999999 [ $\times 10^{\text{STM}}$ $\mu\text{m}$ ] 0 to 99.9999 [ $\times 10^{\text{STM}}$ inch] 0 to 999.999 [degree] 0 to 999999 [pulse]	Set a travel distance. Operation starts with ST1 (Forward rotation start) or ST2 (Reverse rotation start).
Servo motor speed	0 to permissible speed [r/min]	Set a command speed for the servo motor in positioning.
Acceleration time constant	0 to 20000 [ms]	Set a time period for the servo motor to reach the rated speed.
Deceleration time constant	0 to 20000 [ms]	Set a time period for the servo motor to decelerate from the rated speed to a stop.
Dwell	0 to 20000 [ms]	Set a dwell. When the dwell is set, the position command for the next point table will be started after the position command for the selected point table is completed and the set dwell is passed. The dwell is disabled when 0 is set for the sub function. Varying-speed operation is enabled when 1, 8, or 9 is set for the sub function and when 0 is set for the dwell.
Sub function	0, 1, 8, and 9	Set sub function. 0: Executes automatic operation for the selected point table. 1: Executes automatic continuous operation without stopping for the next point table. 8: Executes automatic continuous operation without stopping for the point table selected at the start. 9: Executes automatic continuous operation without stopping for the point table No. 1.
M code	0 to 99	Set a code to be outputted when the positioning completes.

Notes: 1. Change the unit to  $\mu\text{m}/\text{inch}/\text{degree}/\text{pulse}$  with [Pr. PT01].

2. STM is the ratio to the setting value of the position data. STM can be changed with [Pr. PT03].

### Example of setting point table data

Point table No.	Target position (position data) [ $\times 10^{\text{STM}}$ $\mu\text{m}$ ] (Note 1)	Servo motor speed [r/min]	Acceleration time constant [ms]	Deceleration time constant [ms]	Dwell [ms]	Sub function	M code
1	1000	2000	200	200	0	*	1
2	1000	1600	100	100	0	0	2
:	:	:	:	:	:	:	:
31	3000	3000	100	100	0	0	99

\* The operation of the next point table is set with the sub function.

● When the sub function is set to 0:

Start signal is required for each point table.

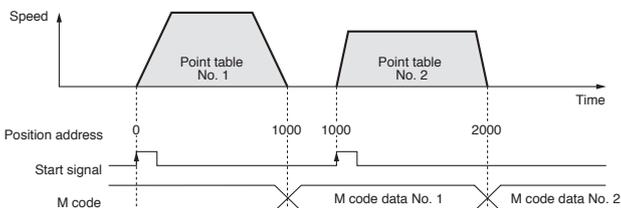

● When the sub function is set to 1:

Automatic continuous operation is executed based on the point table.

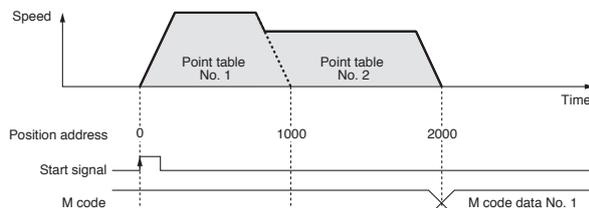

Notes: 1. STM is the ratio to the setting value of the position data. STM can be changed with [Pr. PT03].



## MR-JE-A Positioning Function: Program Method

Positioning operation is executed by selecting programs with command signals. The programs including position data, servo motor speed, acceleration/deceleration time constants and others need to be created beforehand. The program method enables more complex positioning operation than the point table method. MR Configurator2 is required to create programs.

Item		Description	
Command method	Command interface	Input: 7 points excluding EM2 (Forced stop 2), output: 3 points excluding ALM (Malfunction), RS-422 communication/RS-485 communication <sup>(Note 2)</sup>	
	Operating specification	Program language (program with MR Configurator2) Program capacity: 480 steps Program points: 16	
	Position command input <sup>(Note 1)</sup>	Absolute value command method	Set with program language. Setting range of feed length: -999999 to 999999 [ $\times 10^{\text{STM}}$ $\mu\text{m}$ ], -99.9999 to 99.9999 [ $\times 10^{\text{STM}}$ inch], -999999 to 999999 [pulse], Setting range of rotation angle: -360.000 to 360.000 [degree]
		Incremental value command method	Set with program language. Setting range of feed length: -999999 to 999999 [ $\times 10^{\text{STM}}$ $\mu\text{m}$ ], -99.9999 to 99.9999 [ $\times 10^{\text{STM}}$ inch], -999999 to 999999 [pulse], Setting range of rotation angle: -999.999 to 999.999 [degree]
	Speed command input	Set servo motor speed, acceleration/deceleration time constants, S-pattern acceleration/deceleration time constants with program language. S-pattern acceleration/deceleration time constants are also settable with [Pr. PC03].	
	System	Signed absolute value command method/signed incremental value command method	
	Analog override	0 V DC to $\pm 10$ V DC/0% to 200%	
	Torque limit	Set by parameters or external analog input (0 V DC to +10 V DC/maximum torque)	
Operation mode	Automatic operation mode	Program	
	Manual operation mode	JOG operation	Inching operation is executed with DI or serial communication function <sup>(Note 2)</sup> according to the speed command set with a parameter.
		Manual pulse generator operation	Manual feeding is executed with a manual pulse generator. Command pulse multiplication: select from $\times 1$ , $\times 10$ , and $\times 100$ with a parameter.
	Home position return mode	Dog type	Returns to home position upon Z-phase pulse after passing through proximity dog. Home position return direction selectable, home position shift distance settable, home position address settable, automatic retract on dog back to home position, automatic stroke retract function
		Count type	Returns to home position upon the encoder pulse count after touching proximity dog. Home position return direction selectable, home position shift distance settable, home position address settable, automatic retract on dog back to home position, automatic stroke retract function
		Data set type	Returns to home position without dog. Any position settable as a home position using manual operation, etc. Home position address settable
		Stopper type	Returns to home position upon hitting the stroke end. Home position return direction selectable, home position address settable
		Home position ignorance (servo-on position as home position)	Sets a home position where SON (Servo-on) signal turns on. Home position address settable
		Dog type rear end reference	Returns to home position with reference to the rear end of proximity dog. Home position return direction selectable, home position shift distance settable, home position address settable, automatic retract on dog back to home position, automatic stroke retract function
		Count type front end reference	Returns to home position with reference to the front end of proximity dog. Home position return direction selectable, home position shift distance settable, home position address settable, automatic retract on dog back to home position, automatic stroke retract function
		Dog cradle type	Returns to home position upon the first Z-phase pulse with reference to the front end of proximity dog. Home position return direction selectable, home position shift distance settable, home position address settable, automatic retract on dog back to home position, automatic stroke retract function
		Dog type adjacent Z-phase reference	Returns to home position upon the last Z-phase pulse with reference to the front end of proximity dog. Home position return direction selectable, home position shift distance settable, home position address settable, automatic retract on dog back to home position, automatic stroke retract function
	Dog type front end reference	Returns to home position to the front end of dog with reference to the front end of proximity dog. Home position return direction selectable, home position shift distance settable, home position address settable, automatic retract on dog back to home position, automatic stroke retract function	
	Dogless Z-phase reference	Returns to home position to Z-phase pulse with reference to the first Z-phase pulse. Home position return direction selectable, home position shift distance settable, home position address settable	
Automatic positioning to home position function	High-speed automatic positioning to a defined home position		
Other functions	Backlash compensation, overtravel prevention with external limit switches (LSP/LSN), roll feed display function, software stroke limit, mark detection (current position latch/interrupt positioning/mark sensor input compensation), simple cam function, encoder following function, command pulse input through function, analog override function		

Notes: 1. STM is the ratio to the setting value of the position data. STM can be changed with [Pr. PT03].

2. Compatible with Mitsubishi general-purpose AC servo protocol (RS-422/RS-485 communication) and MODBUS<sup>®</sup> RTU protocol (RS-485 communication).

## MR-JE-A Positioning Function: Program Method

A

### Command List

Command	Name	Setting range	Description
SPN(setting value) (Note 2)	Servo motor speed	0 to instantaneous permissible speed [r/min]	Set a command speed for the servo motor in positioning. Do not set a value exceeding the instantaneous permissible speed of the servo motor.
STA(setting value) (Note 2)	Acceleration time constant	0 to 20000 [ms]	Set acceleration time constant. The setting value is a time period that the servo motor reaches the rated speed from a stop.
STB(setting value) (Note 2)	Deceleration time constant	0 to 20000 [ms]	Set deceleration time constant. The setting value is a time period that the servo motor stops from the rated speed.
STC(setting value) (Note 2)	Acceleration/ deceleration time constants	0 to 20000 [ms]	Set acceleration and deceleration time constants. The setting value is a time period that the servo motor reaches the rated speed from a stop and stops from the rated speed.
STD(setting value) (Note 2)	S-pattern acceleration/ deceleration time constants	0 to 1000 [ms]	Set S-pattern acceleration/deceleration time constants.
MOV(setting value) (Note 4, 5)	Absolute value travel command	-999999 to 999999 [ $\times 10^{\text{STM}}$ $\mu\text{m}$ ] -99.9999 to 99.9999 [ $\times 10^{\text{STM}}$ inch]	Travels according to the value set as an absolute value.
MOVA(setting value) (Note 4, 5)	Absolute value continuous travel command	-360.000 to 360.000 [degree] -999999 to 999999 [pulse]	Travels continuously according to the value set as an absolute value. Be sure to write this command after [MOV] command.
MOVI(setting value) (Note 4, 5)	Incremental value travel command	-999999 to 999999 [ $\times 10^{\text{STM}}$ $\mu\text{m}$ ] -99.9999 to 99.9999 [ $\times 10^{\text{STM}}$ inch]	Travels according to the value set as an incremental value.
MOVIA(setting value) (Note 4, 5)	Incremental value continuous travel command	-999.999 to 999.999 [degree] -999999 to 999999 [pulse]	Travels continuously according to the value set as an incremental value. Be sure to write this command after [MOVI] command.
SYNC(setting value) (Note 1)	Waiting for external signal to switch on	1 to 3	Stops the next step until PI1 (Program input 1) to PI3 (Program input 3) turn on after SOUT (SYNC synchronous output) is outputted.
OUTON(setting value) (Note 1)	External signal on output	1 to 3	Turns on OUT1 (Program output 1) to OUT3 (Program output 3).
OUTOF(setting value) (Note 1)	External signal off output	1 to 3	Turns off OUT1 (Program output 1) to OUT3 (Program output 3) which were turned on with [OUTON] command.
TRIP(setting value) (Note 1, 4, 5)	Absolute value trip point specification	-999999 to 999999 [ $\times 10^{\text{STM}}$ $\mu\text{m}$ ] -99.9999 to 99.9999 [ $\times 10^{\text{STM}}$ inch] -360.000 to 360.000 [degree] -999999 to 999999 [pulse]	Executes the next step after [MOV] or [MOVA] commands are started and then the servo motor moves for the travel amount set in [TRIP] command. Be sure to write this command after [MOV] or [MOVA] command.
TRIP1(setting value) (Note 1, 4, 5)	Incremental value trip point specification	-999999 to 999999 [ $\times 10^{\text{STM}}$ $\mu\text{m}$ ] -99.9999 to 99.9999 [ $\times 10^{\text{STM}}$ inch] -999.999 to 999.999 [degree] -999999 to 999999 [pulse]	Executes the next step after [MOVI] or [MOVIA] commands are started and then the servo motor moves for the travel amount set in [TRIP1] command. Be sure to write this command after [MOVI] or [MOVIA] command.
ITP(setting value) (Note 1, 3, 4, 5)	Interrupt positioning	-999999 to 999999 [pulse]	Stops the operation after the servo motor moves for the travel amount set when the interrupt signal is inputted. Be sure to write this command after [SYNC] command.
COUNT(setting value) (Note 1)	External pulse count	-999999 to 999999 [pulse]	Executes the next step when the value of the pulse counter exceeds the count value set in [COUNT] command. [COUNT (0)] clears the pulse counter to zero.
FOR(setting value) NEXT	Step repeat command	0, and 1 to 10000 [number of times]	Repeats the steps between [FOR (setting value)] and [NEXT] commands for the number of times set. Repeats endlessly with [FOR (0) NEXT].
LPOS (Note 1)	Current position latch	-	Latches the current position with the rising edge of the LPS signal. The latched current position data can be read with the communication command.
TIM(setting value)	Dwell	1 to 20000 [ms]	Waits for the next step until the set time passes.
ZRT	Home position return	-	Executes a manual home position return.
TIMES(setting value)	Program count command	0, and 1 to 10000 [number of times]	Set the number of program execution by writing [TIMES (setting value)] command in the first line of the program. The setting is not required for executing once. Repeats endlessly with [TIMES (0)].
STOP	Program stop	-	Stops the program in execution. Be sure to write this command in the final line.

Notes: 1. [SYNC], [OUTON], [OUTOF], [TRIP], [TRIP1], [ITP], [COUNT], and [LPOS] commands are valid while the commands are outputted.

2. [SPN] command is valid while [MOV], [MOVA], [MOVI], or [MOVIA] command is in execution. [STA], [STB], [STC], and [STD] commands are valid while [MOV] or [MOVI] command is in execution.

3. [ITP] command will be skipped to the next step when the remaining distance equals to or less than the setting value, when the servo motor is not running, or when the servo motor is decelerating.

4. Change the unit to  $\mu\text{m}$ /inch/degree/pulse with [Pr. PT01].

5. STM is the ratio to the setting value of the position data. STM can be changed with [Pr. PT03].

Servo Amplifiers

Servo Motors

Options/Peripheral Equipment

LVS/Wires

Product List

Cautions

## MR-JE-A Positioning Function: Program Method

A

### Command list

Command	Name	Setting range	Description
TLP(setting value)	Forward rotation torque limit	0, and 1 to 1000 [0.1%]	Limits the torque generated by the servo motor driving in CCW and regenerating in CW, as the maximum torque is 100%. The setting remains valid until the program is stopped. [TLP (0)] enables the setting of [Pr. PA11].
TLN(setting value)	Reverse rotation torque limit	0, and 1 to 1000 [0.1%]	Limits the torque generated by the servo motor driving in CW and regenerating in CCW, as the maximum torque is 100%. The setting remains valid until the program is stopped. [TLN (0)] enables the setting of [Pr. PA12].
TQL(setting value)	Torque limit	0, and 1 to 1000 [0.1%]	Limits the torque generated by the servo motor, as the maximum torque is 100%. The setting remains valid until the program is stopped. [TQL (0)] enables the settings of [Pr. PA11] and [Pr. PA12].

### Program example 1

The following is an example of executing two types of operations with the same servo motor speed and acceleration/deceleration time constants but the different travel commands.

Step	Program <sup>(Note 1)</sup>	Description
(1)	SPN(3000)	Servo motor speed: 3000 [r/min]
(2)	STA(200)	Acceleration time constant: 200 [ms]
(3)	STB(300)	Deceleration time constant: 300 [ms]
(4)	MOV(1000)	Absolute value travel command: 1000 [ $\times 10^{STM} \mu\text{m}$ ]
(5)	TIM(100)	Dwell: 100 [ms]
(6)	MOV(2500)	Absolute value travel command: 2500 [ $\times 10^{STM} \mu\text{m}$ ]
(7)	STOP	Program stop

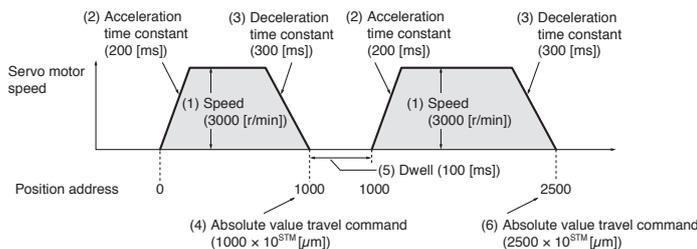

### Program example 2

The following is an example of repeating the steps between [FOR (setting value)] and [NEXT] commands for the number of times set.

Step	Program <sup>(Note 1)</sup>	Description
(1)	SPN(3000)	Servo motor speed: 3000 [r/min]
(2)	STC(20)	Acceleration/deceleration time constants: 20 [ms]
(3)	MOV(1000)	Absolute value travel command: 1000 [ $\times 10^{STM} \mu\text{m}$ ]
(4)	TIM(100)	Dwell: 100 [ms]
(5)	FOR(3)	Starting the step repeat command: 3 [number of times]
(6)	MOVI(100)	Incremental value travel command: 100 [ $\times 10^{STM} \mu\text{m}$ ]
(7)	TIM(100)	Dwell: 100 [ms]
(8)	NEXT	Ending the step repeat command
(9)	STOP	Program stop

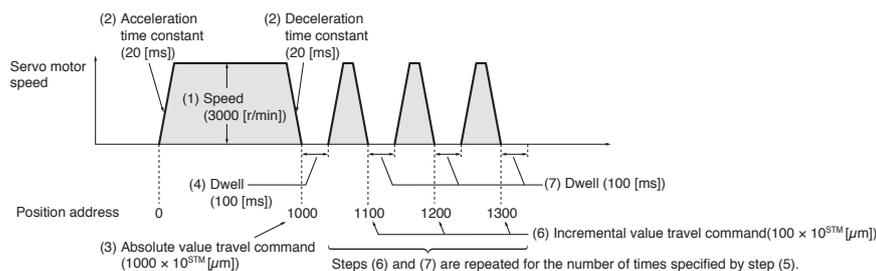

Notes: 1. The values in [SPN], [STA], [STB], and [STC] commands remains valid until they are reset. The values will not be initialized at the start of the program. The settings are also valid in other programs.

## MR-JE-A Standard Wiring Diagram Example: Program Methods

A

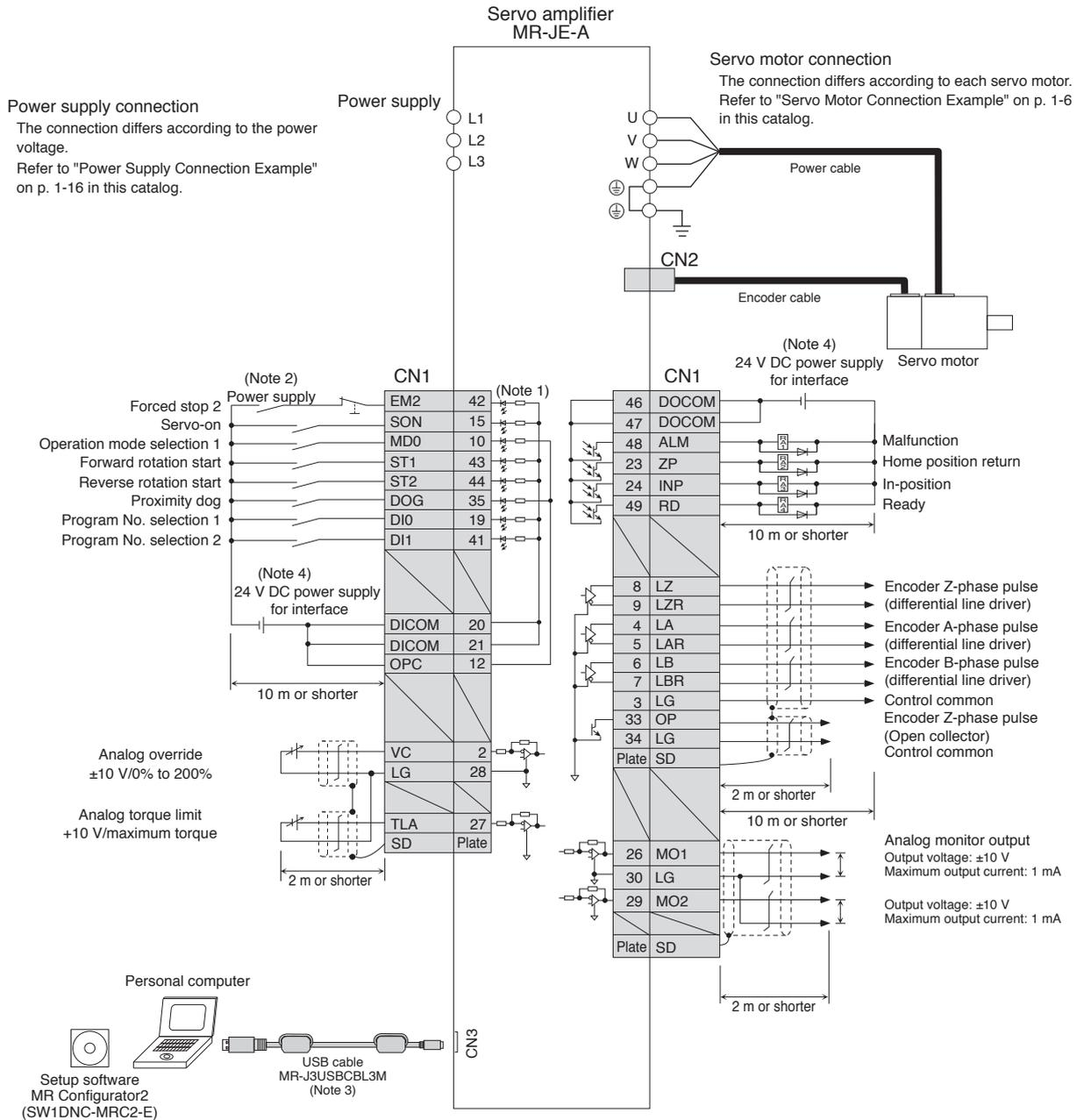

Servo Amplifiers

Servo Motors

Options/Peripheral Equipment

LVS/Wires

Product List

Cautions



Be sure to read through Instruction Manual for the actual wiring and use. Use the equipment after you have a full knowledge of the equipment, safety information and instructions.

## Simple Cam Specifications

Items		Specifications	
Memory capacity	Storage area for cam data	8 Kbytes (FLASH-ROM)	
	Working area for cam data	8 Kbytes (RAM)	
Number of registration		Maximum 8 (depending on cam resolution and coordinate number)	
Comment		Maximum 32 single-byte characters for each cam data	
Cam data	Stroke ratio data type	Cam resolution (Maximum number of registration)	256 (8), 512 (4), 1024 (2), 2048 (1)
		Stroke ratio	-100.000% to 100.000%
	Coordinate data type	Coordinate number (Maximum number of registration)	2 to 1024 Example: 128 (8), 256 (4), 512 (2), 1024 (1)
		Coordinate data	Input value: 0 to 999999 Output value: -999999 to 999999
Cam curve		12 types (constant speed/constant acceleration/5th curve/single hypotenuse/cycloid/distorted trapezoid/distorted sine/distorted constant speed/trapezoid/reverse trapezoid/double hypotenuse/reverse double hypotenuse)	



## MR-JE-A Dimensions

- MR-JE-10A (Note 1)
- MR-JE-20A (Note 1)
- MR-JE-40A (Note 1)

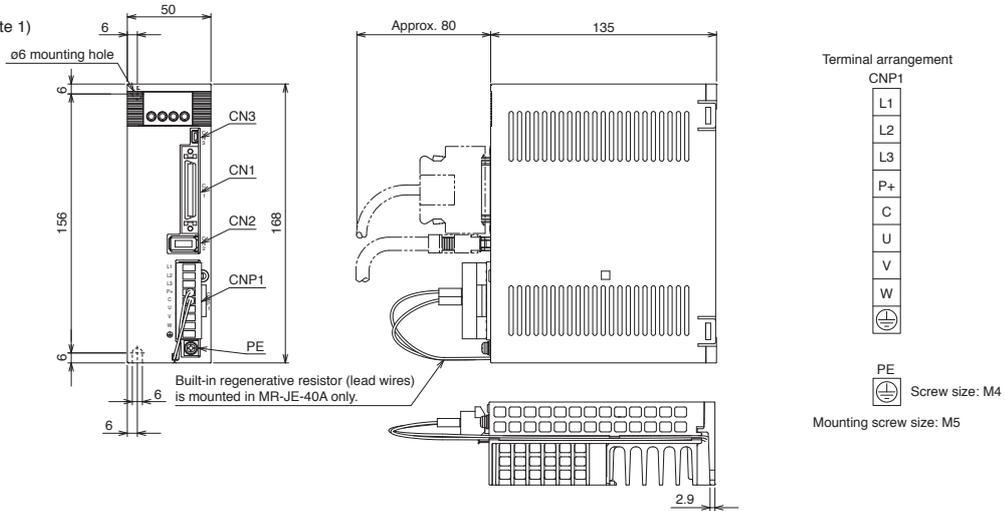

[Unit: mm]

- MR-JE-70A (Note 1)
- MR-JE-100A (Note 1)

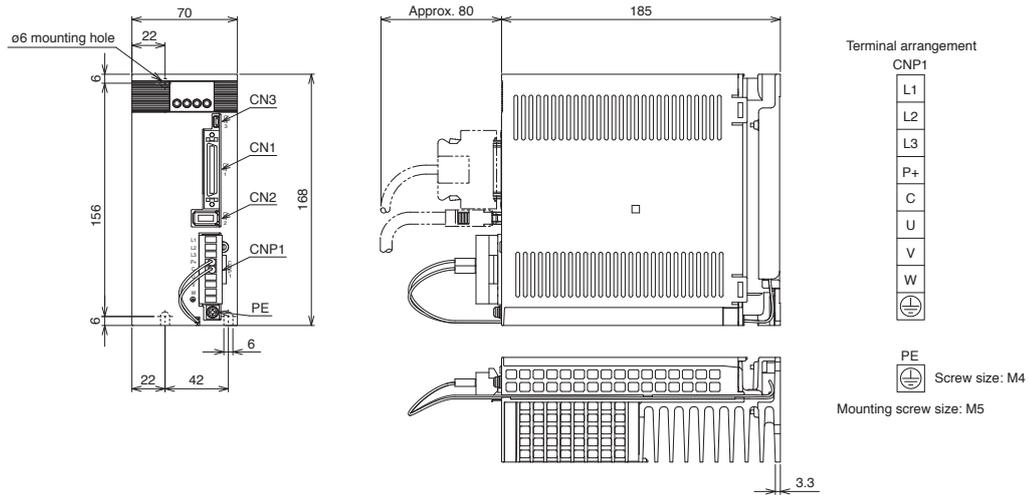

[Unit: mm]

- MR-JE-200A (Note 2)
- MR-JE-300A (Note 2)

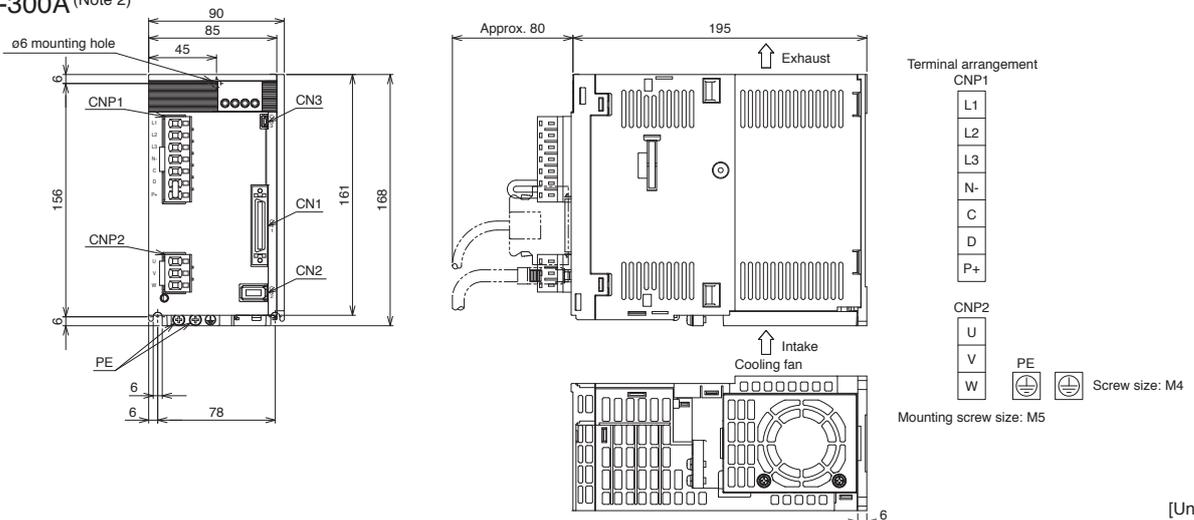

[Unit: mm]

Notes: 1. CNP1 connector (insertion type) is supplied with the servo amplifier.  
 2. CNP1 and CNP2 connectors (insertion type) are supplied with the servo amplifier.

MEMO

# 2

Model Designation.....	2-1
Combinations of Servo Motor and Servo Amplifier.....	2-1
Specifications	
HG-KN series .....	2-2
HG-SN series .....	2-4
Dimensions	
HG-KN series .....	2-7
HG-SN series .....	2-10
Sizing Example.....	2-11

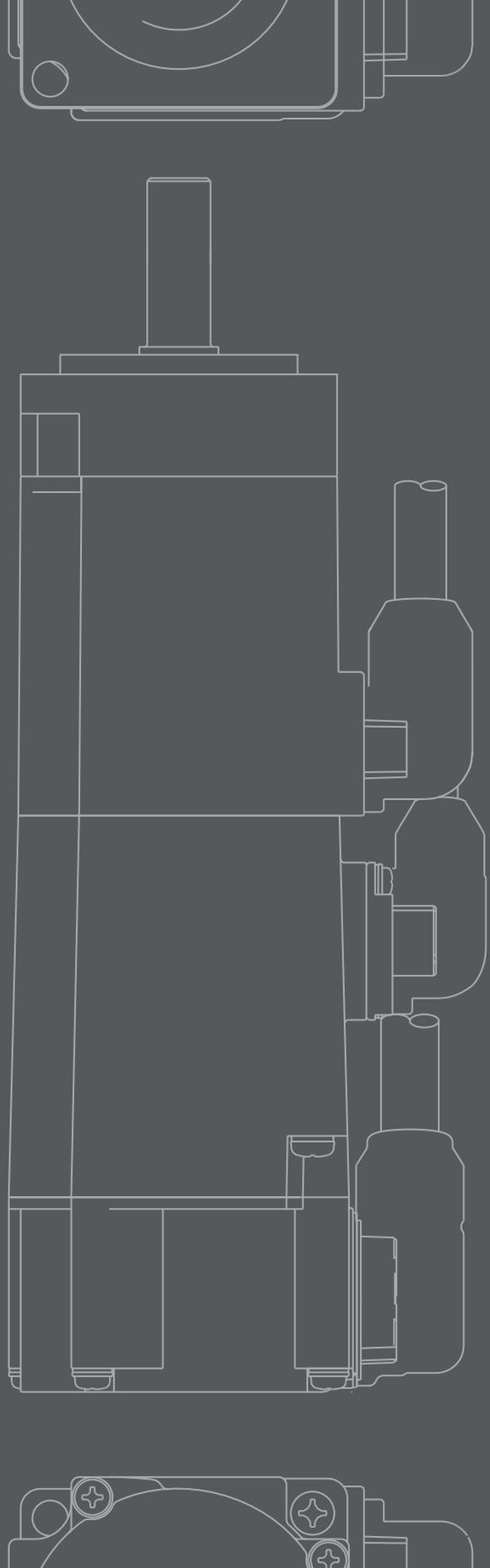

## Servo Motors

## Model Designation

HG - KN 1 3 B J □

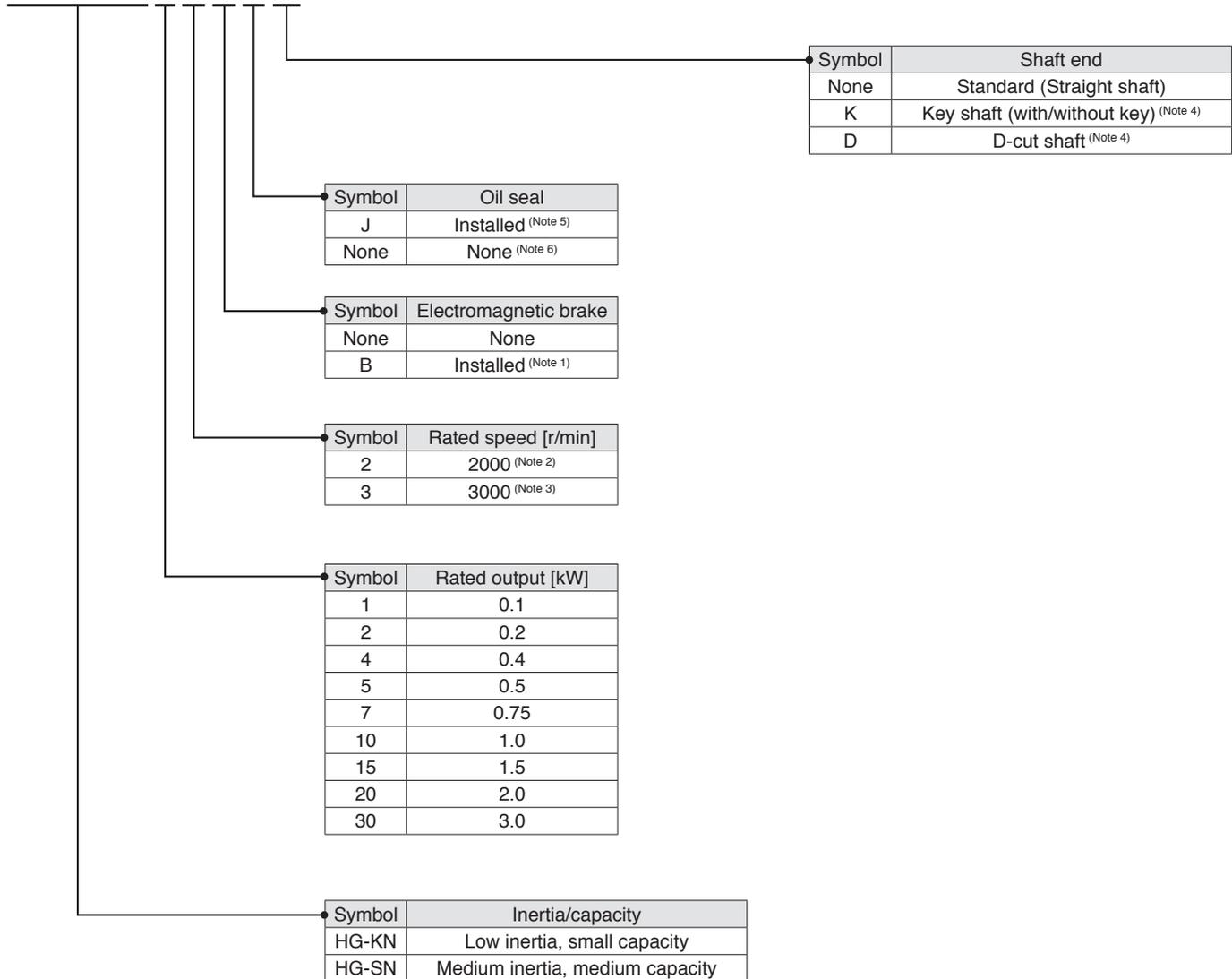

- Notes: 1. Refer to electromagnetic brake specifications of each servo motor series in this catalog for the available models and detailed specifications.  
 2. 2000 r/min is for HG-SN series only.  
 3. 3000 r/min is for HG-KN series only.  
 4. Refer to special shaft end specifications of each servo motor series in this catalog for the available models and detailed specifications.  
 5. An oil seal is attached as a standard for all servo motors.  
 6. Available in HG-KN13 to HG-KN43.

## Combinations of Servo Motor and Servo Amplifier

	Servo motor	Servo amplifier
HG-KN series	HG-KN13(B)J	MR-JE-10B/MR-JE-10A
	HG-KN23(B)J	MR-JE-20B/MR-JE-20A
	HG-KN43(B)J	MR-JE-40B/MR-JE-40A
	HG-KN73(B)J	MR-JE-70B/MR-JE-70A
HG-SN series	HG-SN52(B)J	MR-JE-70B/MR-JE-70A
	HG-SN102(B)J	MR-JE-100B/MR-JE-100A
	HG-SN152(B)J	MR-JE-200B/MR-JE-200A
	HG-SN202(B)J	MR-JE-200B/MR-JE-200A
	HG-SN302(B)J	MR-JE-300B/MR-JE-300A

## HG-KN Series (Low Inertia, Small Capacity) Specifications

Servo motor model		HG-KN	13(B)J	23(B)J	43(B)J	73(B)J
Compatible servo amplifier model		Refer to "Combinations of Servo Motor and Servo Amplifier" on p. 2-1 in this catalog.				
Power supply capacity <sup>1</sup>		[kVA]	0.3	0.5	0.9	1.3
Continuous running duty	Rated output	[W]	100	200	400	750
	Rated torque <sup>(Note 3)</sup>	[N·m]	0.32	0.64	1.3	2.4
Maximum torque		[N·m]	0.95	1.9	3.8	7.2
Rated speed		[r/min]	3000			
Maximum speed		[r/min]	5000			
Permissible instantaneous speed		[r/min]	5750			
Power rate at continuous rated torque	Standard	[kW/s]	12.9	18.0	43.2	44.5
	With electromagnetic brake	[kW/s]	12.0	16.4	40.8	41.0
Rated current		[A]	0.8	1.3	2.6	4.8
Maximum current		[A]	2.4	3.9	7.8	14
Regenerative braking frequency <sup>2, 3</sup>		[times/min]	(Note 4)	(Note 5)	276	159
Moment of inertia J	Standard	[ $\times 10^{-4}$ kg·m <sup>2</sup> ]	0.0783	0.225	0.375	1.28
	With electromagnetic brake	[ $\times 10^{-4}$ kg·m <sup>2</sup> ]	0.0843	0.247	0.397	1.39
Recommended load to motor inertia ratio <sup>(Note 1)</sup>		15 times or less				
Speed/position detector	Combination with MR-JE-B	Absolute/incremental 17-bit encoder (resolution: 131072 pulses/rev)				
	Combination with MR-JE-A	Incremental 17-bit encoder (resolution: 131072 pulses/rev)				
Oil seal		Installed. Without oil seal is also available.				Installed
Insulation class		130 (B)				
Structure		Totally enclosed, natural cooling (IP rating: IP65) <sup>(Note 2)</sup>				
Environment <sup>4</sup>	Ambient temperature	Operation: 0 °C to 40 °C (non-freezing), storage: -15 °C to 70 °C (non-freezing)				
	Ambient humidity	Operation: 80 %RH maximum (non-condensing), storage: 90 %RH maximum (non-condensing)				
	Ambience	Indoors (no direct sunlight); no corrosive gas, inflammable gas, oil mist or dust				
	Altitude	1000 m or less above sea level				
Vibration resistance <sup>5</sup>		X: 49 m/s <sup>2</sup> Y: 49 m/s <sup>2</sup>				
Vibration rank		V10 <sup>7</sup>				
Compliance to global standards		Refer to "Conformity with global standards and regulations" on p. 19 in this catalog.				
Permissible load for the shaft <sup>6</sup>	L	[mm]	25	30	30	40
	Radial	[N]	88	245	245	392
	Thrust	[N]	59	98	98	147
Mass	Standard	[kg]	0.6	0.98	1.5	3.0
	With electromagnetic brake	[kg]	0.8	1.4	1.9	4.0

Notes: 1. Contact your local sales office if the load to motor inertia ratio exceeds the value in the table.

2. The shaft-through portion is excluded. Refer to the asterisk 8 of "Annotations for Servo Motor Specifications" on p. 2-6 in this catalog for the shaft-through portion.

3. When unbalanced torque is generated, such as in a vertical lift machine, keep the unbalanced torque of the machine under 70% of the servo motor rated torque.

4. When the servo motor decelerates to a stop from the rated speed, the regenerative frequency will not be limited. When the servo motor decelerates to a stop from the maximum speed, the regenerative frequency will not be limited if the load to motor inertia ratio is 11 times or less.

5. When the servo motor decelerates to a stop from the rated speed, the regenerative frequency will not be limited if the load to motor inertia ratio is 9 times or less. When the servo motor decelerates to a stop from the maximum speed, the regenerative frequency will not be limited if the load to motor inertia ratio is 3 times or less.

Refer to "Annotations for Servo Motor Specifications" on p. 2-6 in this catalog for the asterisks 1 to 7.

## HG-KN Series Electromagnetic Brake Specifications (Note 1)

Servo motor model	HG-KN	13BJ	23BJ	43BJ	73BJ
Type	Spring actuated type safety brake				
Rated voltage	24 V DC $_{-10}^{0}\%$				
Power consumption [W] at 20 °C		6.3	7.9	7.9	10
Electromagnetic brake static friction torque [N·m]		0.32	1.3	1.3	2.4
Permissible braking work	Per braking [J]	5.6	22	22	64
	Per hour [J]	56	220	220	640
Electromagnetic brake life (Note 2)	Number of brakings [Times]	20000	20000	20000	20000
	Work per braking [J]	5.6	22	22	64

Notes: 1. The electromagnetic brake is for holding. It should not be used for deceleration applications.  
 2. Brake gap is not adjustable. Electromagnetic brake life is defined as the time period until the readjustment is needed.

## HG-KN Series Torque Characteristics

HG-KN13(B)J (Note 1, 2, 3)

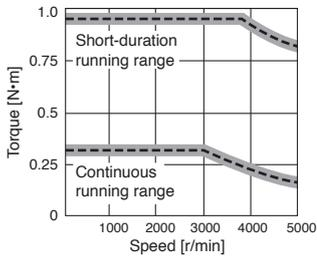

HG-KN23(B)J (Note 1, 2, 3)

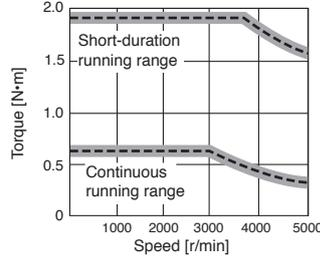

HG-KN43(B)J (Note 1, 2, 3)

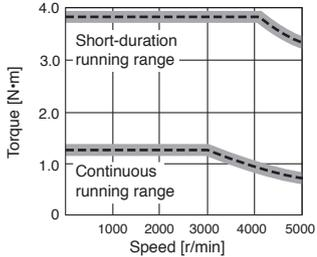

HG-KN73(B)J (Note 1, 2, 3)

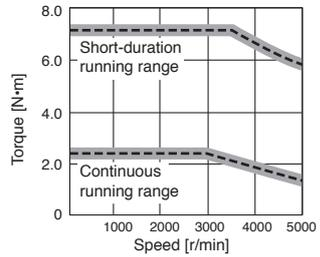

Notes: 1. ——— : For 3-phase 200 V AC.  
 2. - - - - : For 1-phase 230 V AC.  
 3. Torque drops when the power supply voltage is below the specified value.

## HG-KN Series Special Shaft End Specifications

Motors with the following specifications are also available.

D-cut shaft (Note 1): 100 W

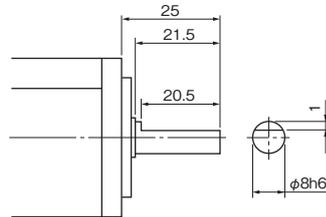

[Unit: mm]

Key shaft (with key) (Note 1, 2): 200 W, 400 W, and 750 W

Model	Variable dimensions								
	T	S	R	Q	W	QK	QL	U	Y
HG-KN23(B)JK, 43(B)JK	5	14h6	30	27	5	20	3	3	M4 screw Depth: 15
HG-KN73(B)JK	6	19h6	40	37	6	25	5	3.5	M5 screw Depth: 20

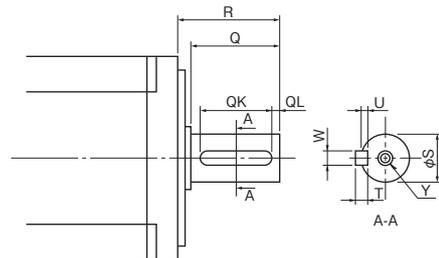

[Unit: mm]

Notes: 1. The servo motors with special shaft end are not suitable for frequent start/stop applications.  
 2. 2 round end key is attached.

## HG-SN Series (Medium Inertia, Medium Capacity) Specifications

Servo motor model		HG-SN	52(B)J	102(B)J	152(B)J	202(B)J	302(B)J	
Compatible servo amplifier model		Refer to "Combinations of Servo Motor and Servo Amplifier" on p. 2-1 in this catalog.						
Power supply capacity <sup>1</sup>		[kVA]	1.0	1.7	2.5	3.5	4.8	
Continuous running duty	Rated output	[kW]	0.5	1.0	1.5	2.0	3.0	
	Rated torque <sup>(Note 3)</sup>	[N·m]	2.39	4.77	7.16	9.55	14.3	
Maximum torque		[N·m]	7.16	14.3	21.5	28.6	42.9	
Rated speed		[r/min]	2000					
Maximum speed		[r/min]	3000					2500
Permissible instantaneous speed		[r/min]	3450					2875
Power rate at continuous rated torque	Standard	[kW/s]	7.85	19.7	32.1	19.5	26.1	
	With electromagnetic brake	[kW/s]	6.01	16.5	28.2	16.1	23.3	
Rated current		[A]	2.9	5.6	9.4	9.6	11	
Maximum current		[A]	9.0	17	29	31	33	
Regenerative braking frequency <sup>2,3</sup>		[times/min]	62	38	139	47	28	
Moment of inertia J	Standard	[ $\times 10^{-4}$ kg·m <sup>2</sup> ]	7.26	11.6	16.0	46.8	78.6	
	With electromagnetic brake	[ $\times 10^{-4}$ kg·m <sup>2</sup> ]	9.48	13.8	18.2	56.5	88.2	
Recommended load to motor inertia ratio <sup>(Note 1)</sup>		15 times or less						
Speed/position detector	Combination with MR-JE-B	Absolute/incremental 17-bit encoder (resolution: 131072 pulses/rev)						
	Combination with MR-JE-A	Incremental 17-bit encoder (resolution: 131072 pulses/rev)						
Oil seal		Installed						
Insulation class		155 (F)						
Structure		Totally enclosed, natural cooling (IP rating: IP67) <sup>(Note 2)</sup>						
Environment <sup>4</sup>	Ambient temperature	Operation: 0 °C to 40 °C (non-freezing), storage: -15 °C to 70 °C (non-freezing)						
	Ambient humidity	Operation: 80 %RH maximum (non-condensing), storage: 90 %RH maximum (non-condensing)						
	Ambience	Indoors (no direct sunlight); no corrosive gas, inflammable gas, oil mist or dust						
	Altitude	1000 m or less above sea level						
Vibration resistance <sup>5</sup>		X: 24.5 m/s <sup>2</sup> Y: 24.5 m/s <sup>2</sup>				X: 24.5 m/s <sup>2</sup> Y: 49 m/s <sup>2</sup>		
Vibration rank		V10 <sup>7</sup>						
Compliance to global standards		Refer to "Conformity with global standards and regulations" on p. 19 in this catalog.						
Permissible load for the shaft <sup>6</sup>	L	[mm]	55	55	55	79	79	
	Radial	[N]	980	980	980	2058	2058	
	Thrust	[N]	490	490	490	980	980	
Mass	Standard	[kg]	4.8	6.2	7.3	11	16	
	With electromagnetic brake	[kg]	6.7	8.2	9.3	17	22	

Notes: 1. Contact your local sales office if the load to motor inertia ratio exceeds the value in the table.

2. The shaft-through portion is excluded. Refer to the asterisk 8 of "Annotations for Servo Motor Specifications" on p. 2-6 in this catalog for the shaft-through portion.

3. When unbalanced torque is generated, such as in a vertical lift machine, keep the unbalanced torque of the machine under 70% of the servo motor rated torque.

Refer to "Annotations for Servo Motor Specifications" on p. 2-6 in this catalog for the asterisks 1 to 7.

## HG-SN Series Electromagnetic Brake Specifications (Note 1)

Servo motor model	HG-SN	52BJ	102BJ	152BJ	202BJ	302BJ
Type	Spring actuated type safety brake					
Rated voltage	24 V DC $-10\%$					
Power consumption [W] at 20 °C		20	20	20	34	34
Electromagnetic brake static friction torque [N·m]		8.5	8.5	8.5	44	44
Permissible braking work	Per braking [J]	400	400	400	4500	4500
	Per hour [J]	4000	4000	4000	45000	45000
Electromagnetic brake life (Note 2)	Number of brakings [Times]	20000	20000	20000	20000	20000
	Work per braking [J]	200	200	200	1000	1000

Notes: 1. The electromagnetic brake is for holding. It should not be used for deceleration applications.  
 2. Brake gap is not adjustable. Electromagnetic brake life is defined as the time period until the readjustment is needed.

## HG-SN Series Torque Characteristics

HG-SN52(B)J (Note 1, 2, 3)

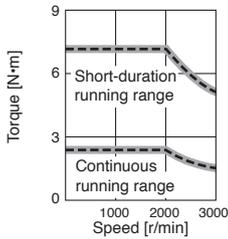

HG-SN102(B)J (Note 1, 2, 3)

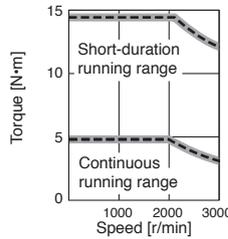

HG-SN152(B)J (Note 1, 2, 3)

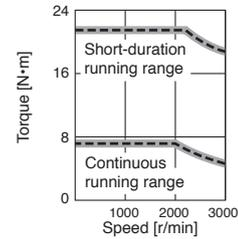

HG-SN202(B)J (Note 1, 2, 3)

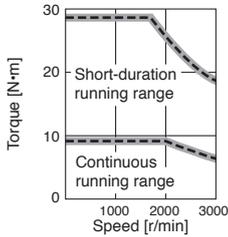

HG-SN302(B)J (Note 1, 3)

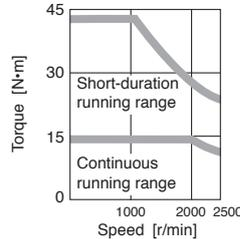

Notes: 1. — : For 3-phase 200 V AC.  
 2. - - - : For 1-phase 230 V AC.  
 3. Torque drops when the power supply voltage is below the specified value.

## HG-SN Series Special Shaft End Specifications

Motors with the following specifications are also available.

Key shaft (without key) (Note 1, 2)

Model	Variable dimensions								
	S	R	Q	W	QK	QL	U	r	Y
HG-SN52(B)JK, 102(B)JK, 152(B)JK	24h6	55	50	8 <sup>0</sup> <sub>-0.036</sub>	36	5	4 <sup>+0.2</sup> <sub>0</sub>	4	M8 screw Depth: 20
HG-SN202(B)JK, 302(B)JK	35 <sup>+0.010</sup> <sub>0</sub>	79	75	10 <sup>0</sup> <sub>-0.036</sub>	55	5	5 <sup>+0.2</sup> <sub>0</sub>	5	

Notes: 1. The servo motors with special shaft end are not suitable for frequent start/stop applications.  
 2. A key is not supplied with the servo motor. The key shall be installed by the user.

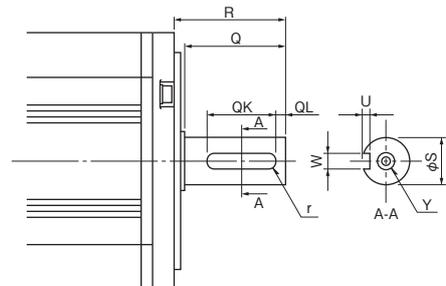

[Unit: mm]



## Annotations for Servo Motor Specifications

- \*1. The power supply capacity varies depending on the power supply impedance.
- \*2. The regenerative braking frequency shows the permissible frequency when the servo motor, without a load and a regenerative option, decelerates from the rated speed to a stop. When a load is connected; however, the value will be the table value/(m+1), where m = Moment of inertia of load/Moment of inertia of servo motor. When the operating speed exceeds the rated speed, the regenerative braking frequency is inversely proportional to the square of (operating speed/rated speed). Take measures to keep the regenerative power [W] during operation below the tolerable regenerative power [W]. Use caution, especially when the operating speed changes frequently or when the regeneration is constant (as with vertical feeds). Select the most suitable regenerative option for your system with our capacity selection software. Refer to "Regenerative Option" in this catalog for the tolerable regenerative power [W] when regenerative option is used.
- \*3. For 400 W or smaller servo amplifiers, the regenerative braking frequency may change affected by the power supply voltage due to the large ratio of the energy charged into the electrolytic capacitor in the servo amplifier.
- \*4. In the environment where the servo motor is exposed to oil mist, oil and/or water, a standard specification servo motor may not be usable. Contact your local sales office for more details.
- \*5. The vibration direction is shown in the diagram below. The numerical value indicates the maximum value of the component (commonly the bracket in the opposite direction of the servo motor shaft). Fretting more likely occurs on the bearing when the servo motor stops. Thus, maintain vibration level at approximately one-half of the allowable value.

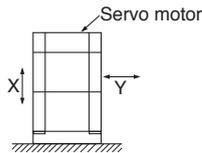

- \*6. Refer to the diagram below for the permissible load for the shaft. Do not apply a load exceeding the value specified in the table on the shaft. The values in the table are applicable when each load is applied singly.

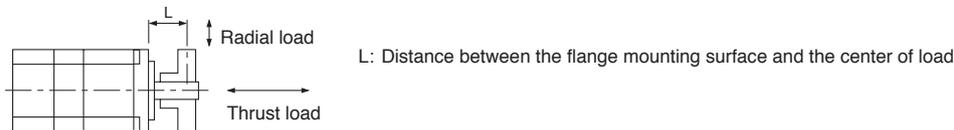

- \*7. V10 indicates that the amplitude of the servo motor itself is 10  $\mu\text{m}$  or less. The following shows mounting posture and measuring position of the servo motor during the measurement:

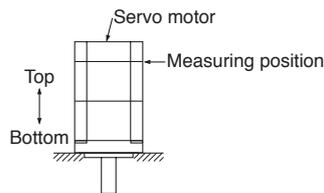

- \*8. Refer to the diagram below for shaft-through portion.

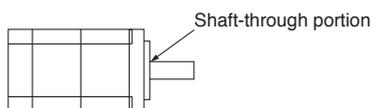

## HG-KN Series Dimensions (Note 1, 5)

### ●HG-KN13(B)J

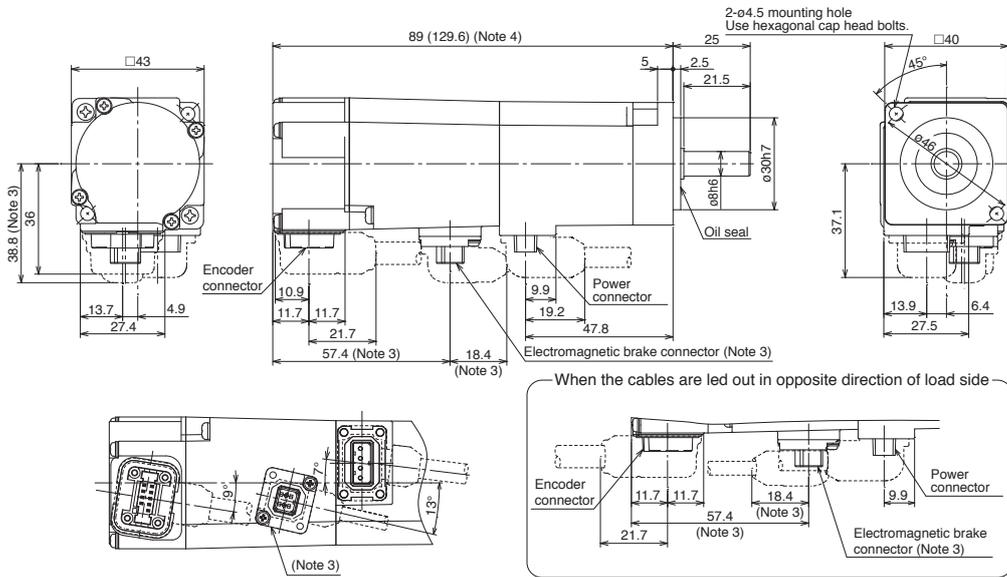

Power connector



Pin No.	Signal name
1	⊕ (PE)
2	U
3	V
4	W

Electromagnetic brake connector (Note 2)



Pin No.	Signal name
1	B1
2	B2

[Unit: mm]

### ●HG-KN13(B)

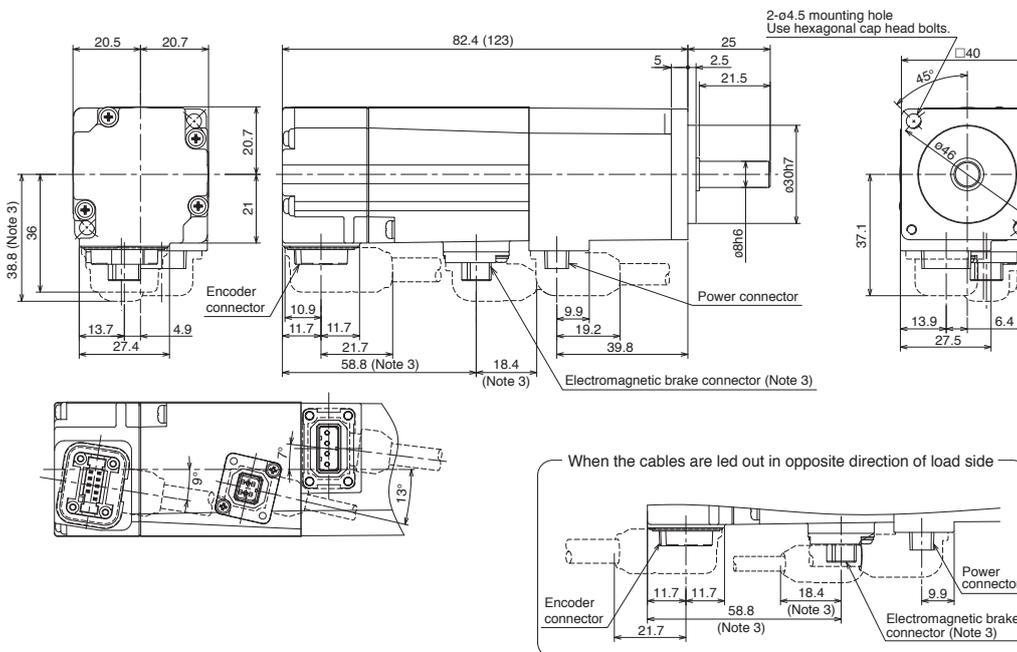

Power connector



Pin No.	Signal name
1	⊕ (PE)
2	U
3	V
4	W

Electromagnetic brake connector (Note 2)



Pin No.	Signal name
1	B1
2	B2

[Unit: mm]

- Notes: 1. For dimensions without tolerance, general tolerance applies.  
 2. The electromagnetic brake terminals (B1, B2) do not have polarity.  
 3. Only for the models with electromagnetic brake.  
 4. Dimensions in brackets are for the models with electromagnetic brake.  
 5. Use a friction coupling to fasten a load.

### HG-KN Series Dimensions (Note 1, 5)

#### ●HG-KN23(B)J, HG-KN43(B)J

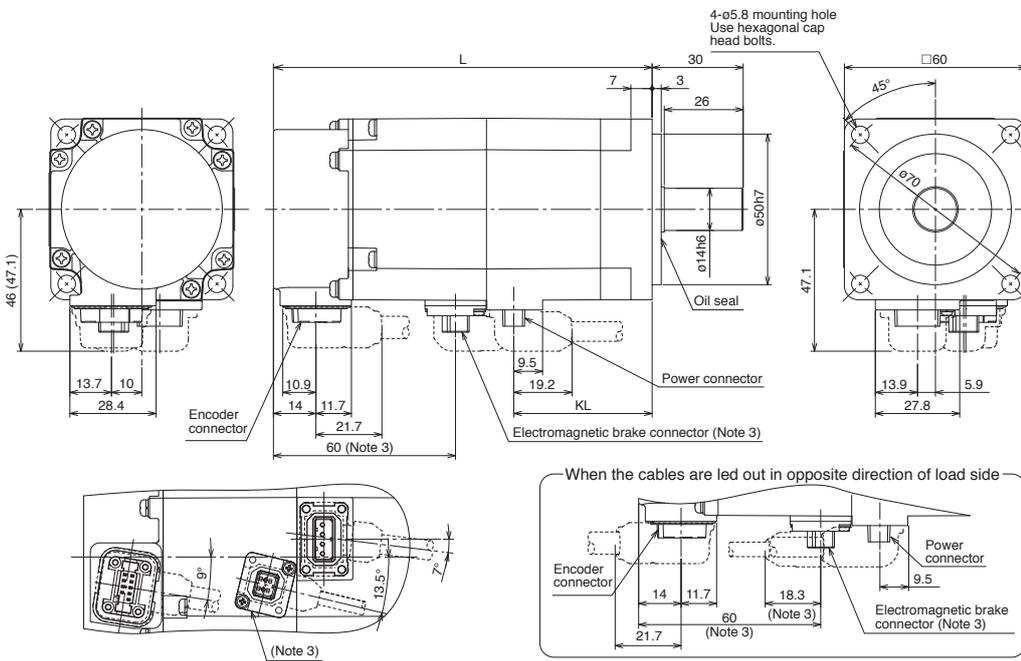

Power connector



Pin No.	Signal name
1	$\oplus$ (PE)
2	U
3	V
4	W

Electromagnetic brake connector (Note 2)



Pin No.	Signal name
1	B1
2	B2

Model	Variable dimensions (Note 4)	
	L	KL
HG-KN23(B)J	88 (124.8)	45.6
HG-KN43(B)J	109.7 (146.5)	67.3

[Unit: mm]

#### ●HG-KN23(B), HG-KN43(B)

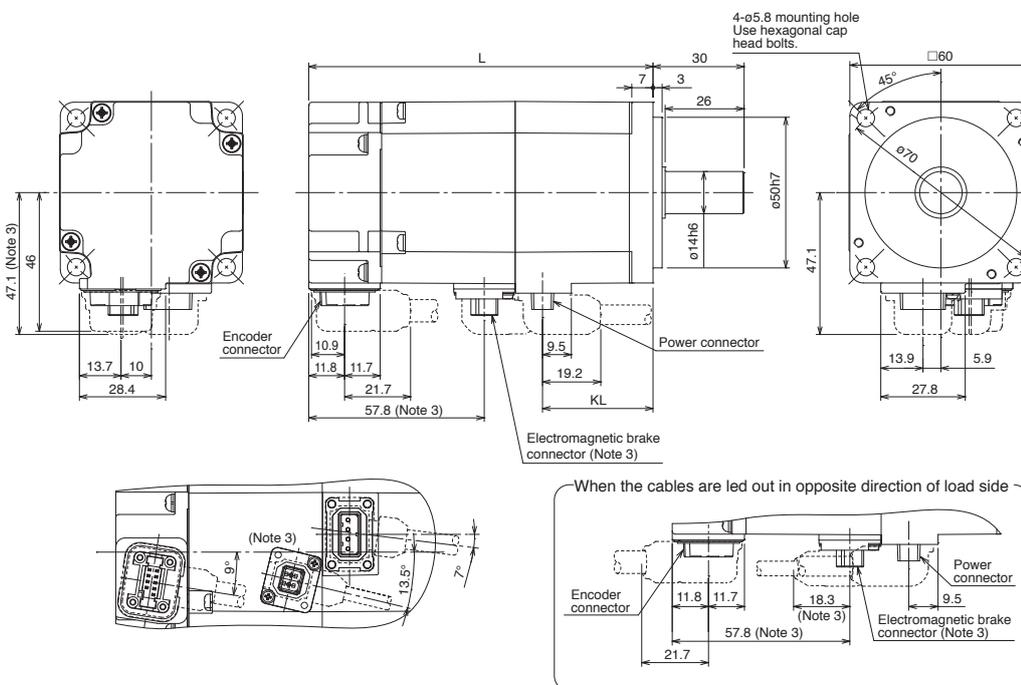

Power connector



Pin No.	Signal name
1	$\oplus$ (PE)
2	U
3	V
4	W

Electromagnetic brake connector (Note 2)



Pin No.	Signal name
1	B1
2	B2

Model	Variable dimensions (Note 4)	
	L	KL
HG-KN23(B)	76.6 (113.4)	36.4
HG-KN43(B)	98.3 (135.1)	58.1

[Unit: mm]

- Notes: 1. For dimensions without tolerance, general tolerance applies.  
 2. The electromagnetic brake terminals (B1, B2) do not have polarity.  
 3. Only for the models with electromagnetic brake.  
 4. Dimensions in brackets are for the models with electromagnetic brake.  
 5. Use a friction coupling to fasten a load.

## HG-KN Series Dimensions (Note 1, 5)

### ●HG-KN73(B)J

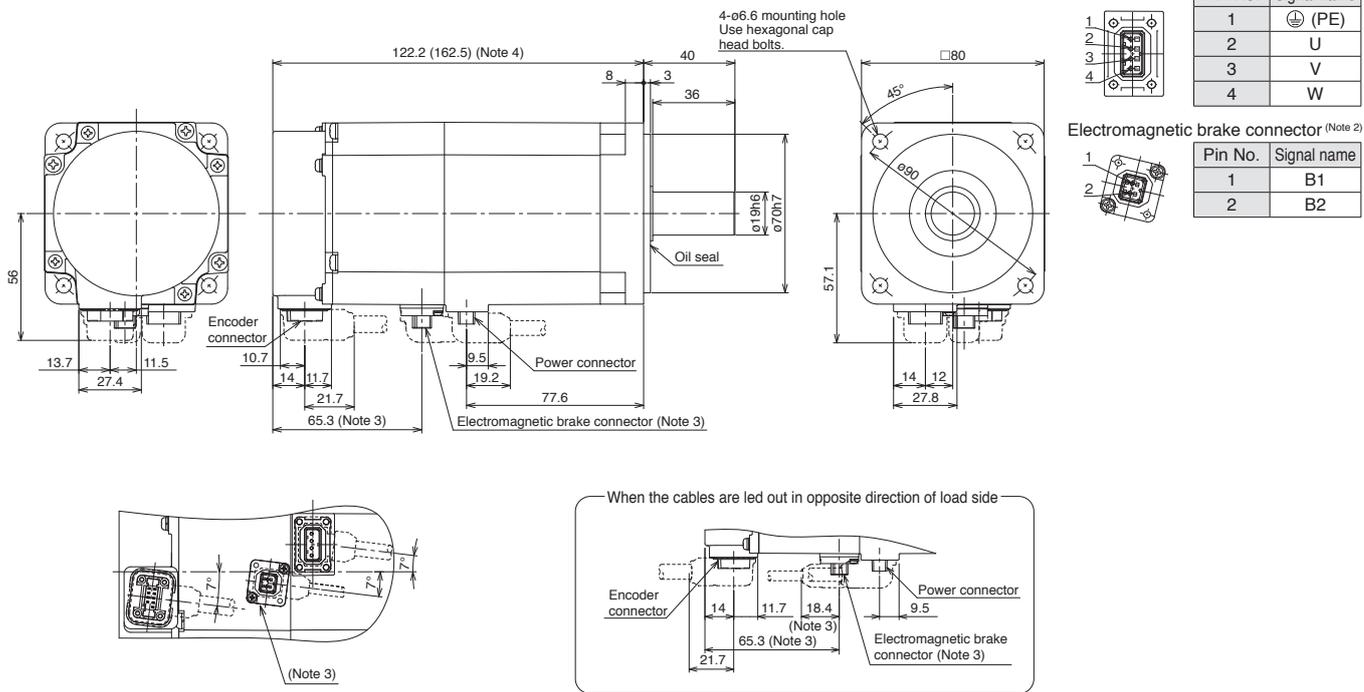

[Unit: mm]

- Notes: 1. For dimensions without tolerance, general tolerance applies.  
 2. The electromagnetic brake terminals (B1, B2) do not have polarity.  
 3. Only for the models with electromagnetic brake.  
 4. Dimensions in brackets are for the models with electromagnetic brake.  
 5. Use a friction coupling to fasten a load.

### HG-SN Series Dimensions (Note 1, 5)

#### ●HG-SN52(B)J, HG-SN102(B)J, HG-SN152(B)J

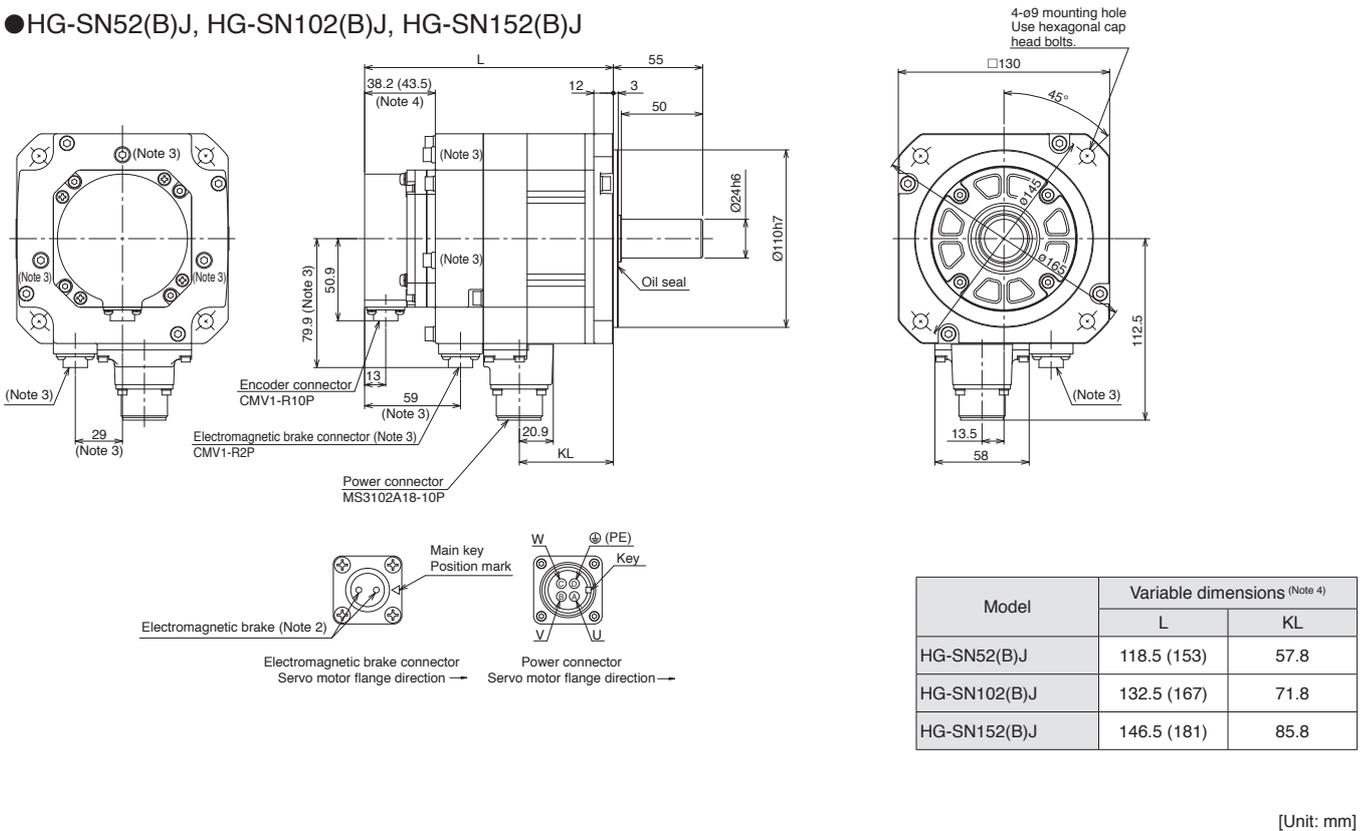

#### ●HG-SN202(B)J, HG-SN302(B)J

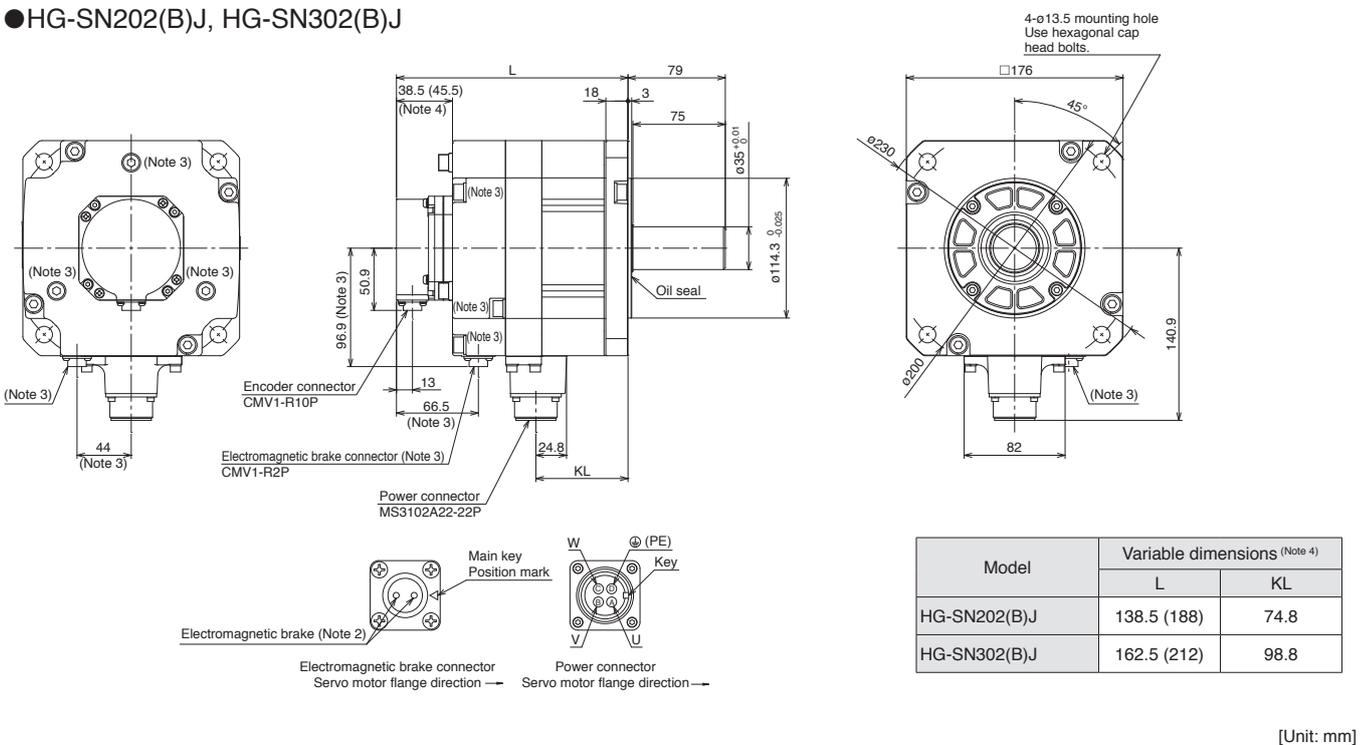

- Notes: 1. For dimensions without tolerance, general tolerance applies.  
 2. The electromagnetic brake terminals do not have polarity.  
 3. Only for the models with electromagnetic brake.  
 4. Dimensions in brackets are for the models with electromagnetic brake.  
 5. Use a friction coupling to fasten a load.

## Servo Motor Sizing Example

### 1. Selection criteria

#### (1) Configurations

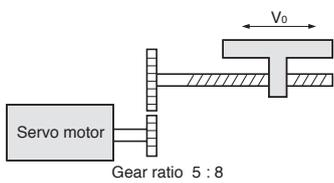

Feed speed of moving part  
 Feed length per cycle  
 Positioning time  
 Number of feed times  
 (Operating cycle)  
 Reduction ratio  
 Moving part mass  
 Drive system efficiency  
 Friction coefficient  
 Ball screw lead

$V_0 = 30000 \text{ mm/min}$   
 $\ell = 400 \text{ mm}$   
 $t_0 = \text{within } 1 \text{ s}$   
 40 times/min  
 $t_r = 1.5 \text{ s}$   
 $1/n = 5/8$   
 $W = 60 \text{ kg}$   
 $\eta = 0.8$   
 $\mu = 0.2$   
 $P_B = 16 \text{ mm}$

$D_B = \text{ball screw diameter } 20 \text{ mm}$   
 $L_B = \text{ball screw length } 500 \text{ mm}$   
 $D_{G1} = \text{gear diameter (servo motor shaft) } 25 \text{ mm}$   
 $D_{G2} = \text{gear diameter (load shaft) } 40 \text{ mm}$   
 $L_G = \text{gear tooth thickness } 10 \text{ mm}$

#### (2) Servo motor speed

$$N_0 = \frac{V_0}{P_B} \times \frac{1}{1/n} = \frac{30000}{16} \times \frac{8}{5} = 3000 \text{ r/min}$$

#### (3) Acceleration/deceleration time constant

$$t_{psa} = t_{psd} = t_0 - \frac{\ell}{V_0/60} - t_s = 0.05 \text{ s}$$

$t_s$ : settling time. Here assumed 0.15 s.

#### (4) Operating pattern

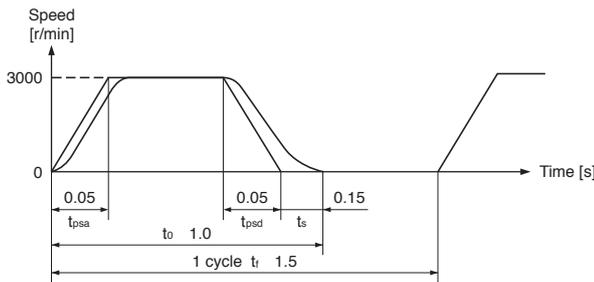

#### (3) Select a servo motor

##### Selection criteria

Load torque < Rated torque of servo motor

Moment of inertia of all loads <  $J_R$  × Moment of inertia of servo motor

$J_R$ : Recommended load to motor inertia ratio

Select the following servo motor to meet the criteria above.

HG-KN23J (rated torque: 0.64 N·m, max. torque: 1.9 N·m, moment of inertia:  $0.24 \times 10^{-4} \text{ kg}\cdot\text{m}^2$ )

#### (4) Acceleration/deceleration torque

Torque required during acceleration

$$T_{Ma} = \frac{(J_L / \eta + J_M) \times N_0}{9.55 \times 10^4 \times t_{psa}} + T_L = 1.84 \text{ N}\cdot\text{m}$$

$J_M$ : moment of inertia of servo motor

Torque required during deceleration

$$T_{Md} = -\frac{(J_L \times \eta + J_M) \times N_0}{9.55 \times 10^4 \times t_{psd}} + T_L = -0.85 \text{ N}\cdot\text{m}$$

Torque required during acceleration/deceleration must be equal to or lower than the max. torque of the servo motor.

## 2. Selecting servo motor

#### (1) Load torque (converted into the servo motor shaft)

Travel distance per servo motor revolution

$$\Delta S = P_B \times \frac{1}{n} = 10 \text{ mm}$$

$$T_L = \frac{\mu \times W \times g \times \Delta S}{2 \times 10^3 \pi \eta} = 0.23 \text{ N}\cdot\text{m}$$

#### (2) Moment of inertia of load (converted into the servo motor shaft)

Moving part

$$J_{L1} = W \times \left( \frac{\Delta S \times 10^{-3}}{2\pi} \right)^2 = 1.52 \times 10^{-4} \text{ kg}\cdot\text{m}^2$$

Ball screw

$$J_{L2} = \frac{\pi \times \rho \times L_B}{32} \times D_B^4 \times \left( \frac{1}{n} \right)^2 = 0.24 \times 10^{-4} \text{ kg}\cdot\text{m}^2$$

$\rho = 7.8 \times 10^3 \text{ kg/m}^3$  (iron)

Gear (servo motor shaft)

$$J_{L3} = \frac{\pi \times \rho \times L_G}{32} \times D_{G1}^4 = 0.03 \times 10^{-4} \text{ kg}\cdot\text{m}^2$$

Gear (load shaft)

$$J_{L4} = \frac{\pi \times \rho \times L_G}{32} \times D_{G2}^4 \times \left( \frac{1}{n} \right)^2 = 0.08 \times 10^{-4} \text{ kg}\cdot\text{m}^2$$

Moment of inertia of all loads (converted into the servo motor shaft)

$$J_L = J_{L1} + J_{L2} + J_{L3} + J_{L4} = 1.87 \times 10^{-4} \text{ kg}\cdot\text{m}^2$$

#### (5) Continuous effective load torque

$$T_{rms} = \sqrt{\frac{T_{Ma}^2 \times t_{psa} + T_L^2 \times t_c + T_{Md}^2 \times t_{psd}}{t_r}} = 0.40 \text{ N}\cdot\text{m}$$

$t_c = t_0 - t_s - t_{psa} - t_{psd}$

Continuous effective load torque must be equal to or lower than the rated torque of the servo motor.

#### (6) Torque pattern

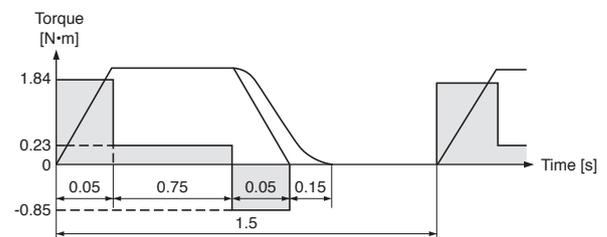

#### (7) Result

Select the following:

Servo motor: HG-KN23J

Servo amplifier: MR-JE-20B

[Free capacity selection software]

Capacity selection software (MRZJW3-MOTSZ111E) does all the calculations for you. The capacity selection software is available for free download. Contact your local sales office for more details.

\* Be sure to update your MRZJW3-MOTSZ111E to the latest version.

# 3

Basic Cable Configurations for Servo Motors.....	3-1
Configuration Example for Servo Motors.....	3-3
Details of Optional Cables and Connectors for Servo Motors ...	3-9
Products on the Market for Servo Motors.....	3-12
Configuration Example for MR-JE-B .....	3-15
Configuration Example for MR-JE-A.....	3-18
Details of Optional Cables and Connectors for Servo Amplifiers ..	3-20
Products on the Market for Servo Amplifiers .....	3-21
Regenerative Option.....	3-22
Battery .....	3-24
Battery Case and Battery .....	3-24
Junction Terminal Block.....	3-25
Radio Noise Filter .....	3-25
Line Noise Filter.....	3-25
Data Line Filter .....	3-25
Surge Killer .....	3-25
EMC Filter.....	3-26
Power Factor Improving Reactor.....	3-27
Servo Support Software .....	3-28

## Options/Peripheral Equipment

## Basic Cable Configurations for Servo Motors

Necessary optional cables and connectors vary depending on the servo motor series.  
Refer to the following tables for necessary options.

### Selecting options for servo motor

Use the cables in the following tables.

For the cable descriptions, refer to the relevant numbers in each list.

Capacity	Servo motor	Reference list		
		Encoder cable	Servo motor power cable	Electromagnetic brake cable <sup>(Note 1)</sup>
Small capacity	HG-KN	Column A in encoder cable list	Column A in servo motor power cable list	Column A in electromagnetic brake cable list
Medium capacity	HG-SN	Column B in encoder cable list	Column B in servo motor power cable list	Column B in electromagnetic brake cable list

Notes: 1. An electromagnetic brake cable is required only for servo motor with electromagnetic brake.

### Encoder cable list

	Cable length	IP rating <sup>(Note 1)</sup>	Cable lead out direction	Bending life	Model	Reference	Note
A	10 m or shorter (direct connection type)	IP65	In direction of load side	Long bending life	MR-J3ENCBL_M-A1-H	p. 3-5	
				Standard	MR-J3ENCBL_M-A1-L		
			In opposite direction of load side	Long bending life	MR-J3ENCBL_M-A2-H	p. 3-5	
				Standard	MR-J3ENCBL_M-A2-L		
	Exceeding 10 m (junction type)	IP20	In direction of load side	Long bending life	Two types of cables are required: MR-J3JCBL03M-A1-L, MR-EKCBL_M-H	p. 3-5	
				Standard	Two types of cables are required: MR-J3JCBL03M-A1-L, MR-EKCBL_M-L		
			In opposite direction of load side	Long bending life	MR-J3JCBL03M-A2-L, MR-EKCBL_M-H	p. 3-5	
				Standard	Two types of cables are required: MR-J3JCBL03M-A2-L, MR-EKCBL_M-L		
		IP65	In direction of load side	Long bending life	Two types of cables are required: MR-J3JSCBL03M-A1-L, MR-J3ENSCBL_M-H	pp. 3-5 and 3-6	
				Standard	Two types of cables are required: MR-J3JSCBL03M-A1-L, MR-J3ENSCBL_M-L		
In opposite direction of load side			Long bending life	Two types of cables are required: MR-J3JSCBL03M-A2-L, MR-J3ENSCBL_M-H	pp. 3-5 and 3-6		
			Standard	Two types of cables are required: MR-J3JSCBL03M-A2-L, MR-J3ENSCBL_M-L			
B	2 m to 50 m	IP67	-	Long bending life	MR-J3ENSCBL_M-H	p. 3-6	
	2 m to 30 m			Standard	MR-J3ENSCBL_M-L		

Notes: 1. The IP rating indicated is for the connector's protection against ingress of dust and water when coupled to a servo amplifier/servo motor. If the IP rating of the servo amplifier/servo motor differs from that of these connectors, overall IP rating depends on the lowest of all.



Servo motor power cable list

	Cable length	IP rating <sup>(Note 1)</sup>	Cable lead out direction	Bending life	Model	Reference	Note
A	10 m or shorter (direct connection type)	IP65	In direction of load side	Long bending life	MR-PWS1CBL_M-A1-H	p. 3-7	Select one from this list.
				Standard	MR-PWS1CBL_M-A1-L		
			In opposite direction of load side	Long bending life	MR-PWS1CBL_M-A2-H	p. 3-7	
				Standard	MR-PWS1CBL_M-A2-L		
Exceeding 10 m (junction type)	IP55	In direction of load side	Standard	Connect a user-fabricated cable to MR-PWS2CBL03M-A1-L (optional cable).		p. 3-7	
				In opposite direction of load side	Connect a user-fabricated cable to MR-PWS2CBL03M-A2-L (optional cable).		

	IP rating <sup>(Note 1)</sup>	Compatible servo motor	Model	Reference	Note
B	IP67	HG-SN52J, 102J, 152J	Fabricate a cable that fits to MR-PWCNS4 (optional connector set).	p. 3-7	Select one that is compatible with the servo motor.
		HG-SN202J, 302J	Fabricate a cable that fits to MR-PWCNS5 (optional connector set).	p. 3-7	

Electromagnetic brake cable list

	Cable length	IP rating <sup>(Note 1)</sup>	Cable lead out direction	Bending life	Model	Reference	Note
A	10 m or shorter (direct connection type)	IP65	In direction of load side	Long bending life	MR-BKS1CBL_M-A1-H	p. 3-8	Select one from this list.
				Standard	MR-BKS1CBL_M-A1-L		
			In opposite direction of load side	Long bending life	MR-BKS1CBL_M-A2-H	p. 3-8	
				Standard	MR-BKS1CBL_M-A2-L		
Exceeding 10 m (junction type)	IP55	In direction of load side	Standard	Connect a user-fabricated cable to MR-BKS2CBL03M-A1-L (optional cable).		p. 3-8	
				In opposite direction of load side	Connect a user-fabricated cable to MR-BKS2CBL03M-A2-L (optional cable).		

	IP rating <sup>(Note 1)</sup>	Compatible servo motor	Model	Reference	Note
B	IP67	HG-SN series	Fabricate a cable that fits to MR-BKCNS1 or MR-BKCNS2 (optional connector set) (straight type).	p. 3-8	Select one from this list.
			Fabricate a cable that fits to MR-BKCNS1A or MR-BKCNS2A (optional connector set) (angle type).	p. 3-8	

Notes: 1. The IP rating indicated is for the connector's protection against ingress of dust and water when coupled to a servo amplifier/servo motor. If the IP rating of the servo amplifier/servo motor differs from that of these connectors, overall IP rating depends on the lowest of all.

## Configuration Example for Servo Motors

For HG-KN servo motor series: encoder cable length 10 m or shorter

- For leading the cables out in direction of load side (Note 1)

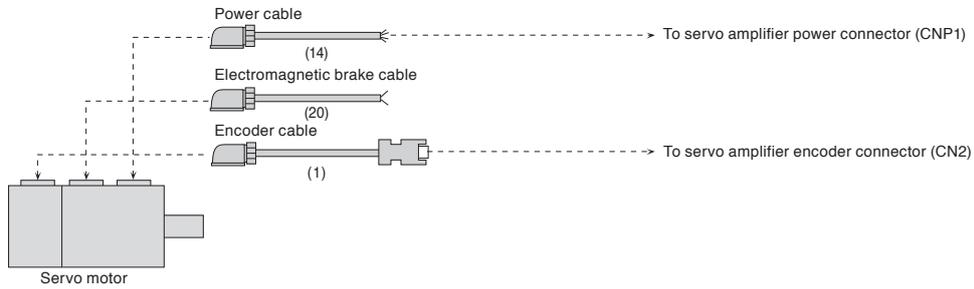

- For leading the cables out in opposite direction of load side (Note 1)

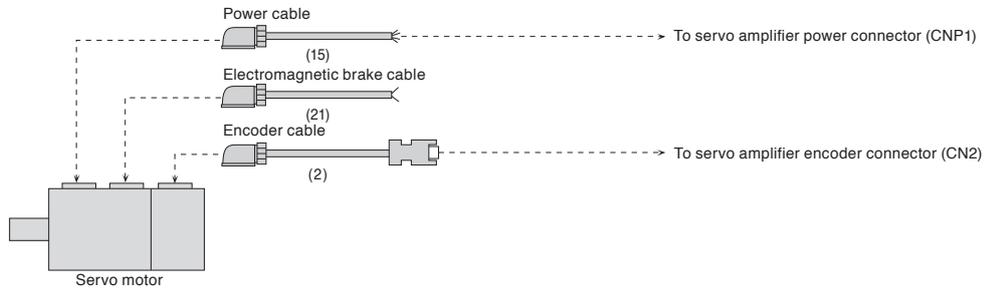

Notes: 1. Cables for leading two different directions may be used for one servo motor.

## Configuration Example for Servo Motors (Note 5)

**B** **A**

For HG-KN servo motor series: encoder cable length over 10 m

● For leading the cables out in direction of load side (Note 4)

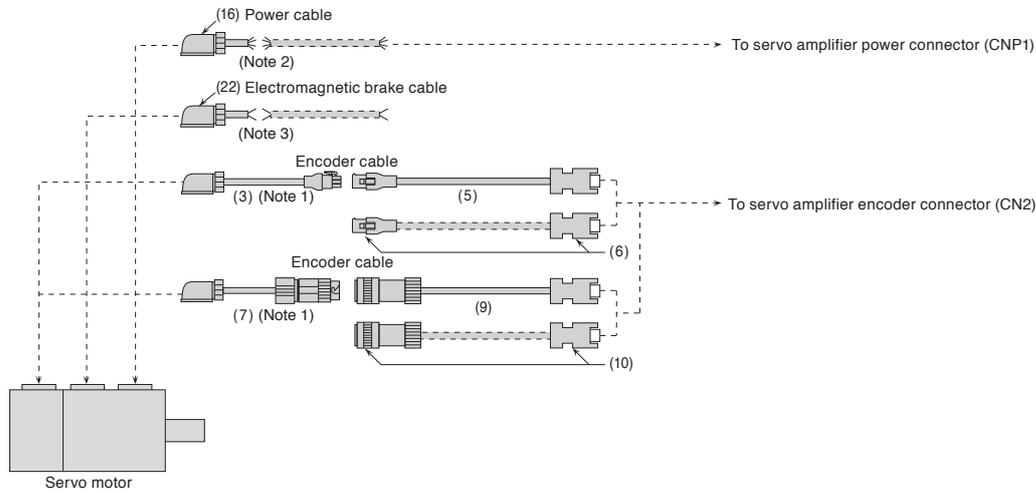

● For leading the cables out in opposite direction of load side (Note 4)

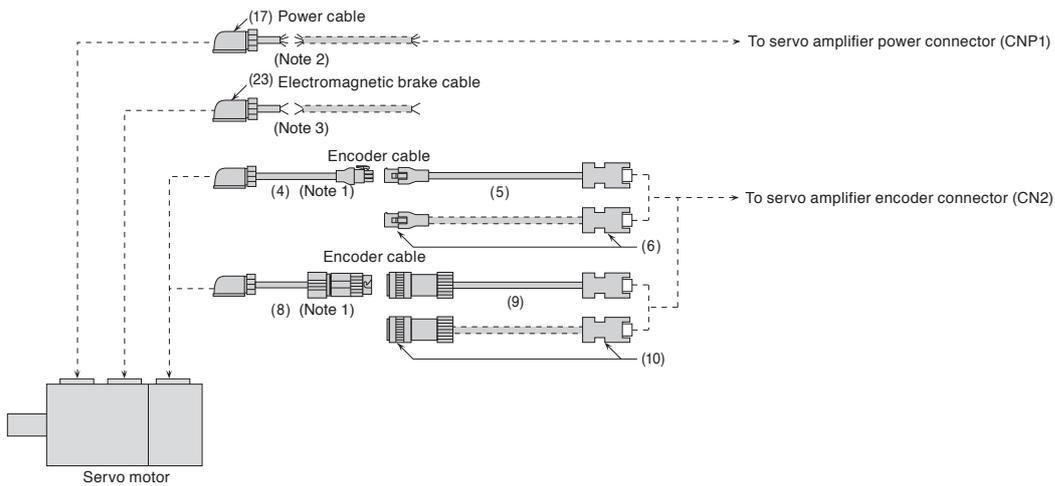

For HG-SN servo motor series

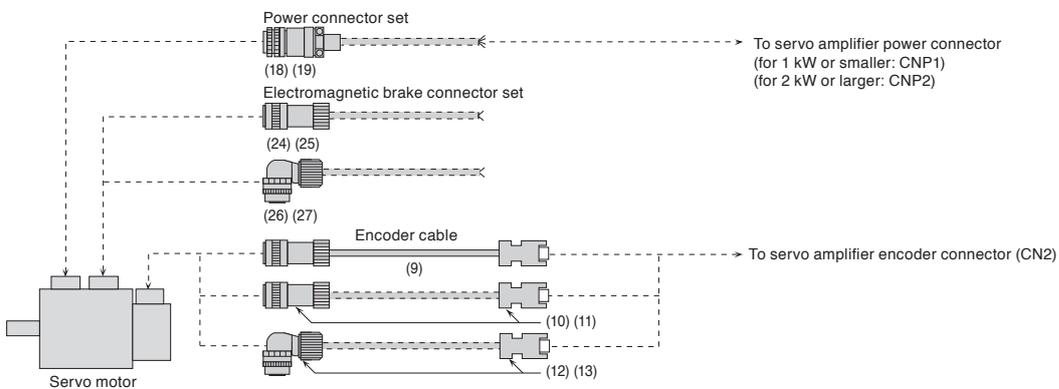

- Notes: 1. This cable does not have a long bending life. Thus, be sure to fix the cable before using.  
 2. Relay a cable using MR-PWS2CBL03M-A1-L or MR-PWS2CBL03M-A2-L. This cable does not have a long bending life. Thus, be sure to fix the cable before using.  
 3. Relay a cable using MR-BKS2CBL03M-A1-L or MR-BKS2CBL03M-A2-L. This cable does not have a long bending life. Thus, be sure to fix the cable before using.  
 4. Cables for leading two different directions may be used for one servo motor.  
 5. Cables drawn with dashed lines need to be fabricated by user. Refer to "HG-KN HG-SN Servo Motor Instruction Manual" for fabricating the cables.

## Cables and Connectors for Servo Motor Encoder

Refer to "Details of Optional Cables and Connectors for Servo Motors" in this catalog for the detailed models.

Item	Model	Cable length	IP rating (Note 1)	Application	Description
(1) Encoder cable (Note 2) (load-side lead)	MR-J3ENCBL2M-A1-H <sup>*1</sup>	2 m	IP65	For HG-KN (direct connection type)	Encoder connector    Servo amplifier connector 
	MR-J3ENCBL5M-A1-H <sup>*1</sup>	5 m			
	MR-J3ENCBL10M-A1-H <sup>*1</sup>	10 m			
	MR-J3ENCBL2M-A1-L <sup>*1</sup>	2 m			
	MR-J3ENCBL5M-A1-L <sup>*1</sup>	5 m			
	MR-J3ENCBL10M-A1-L <sup>*1</sup>	10 m			
(2) Encoder cable (Note 2) (opposite to load-side lead)	MR-J3ENCBL2M-A2-H <sup>*1</sup>	2 m	IP65	For HG-KN (direct connection type)	
	MR-J3ENCBL5M-A2-H <sup>*1</sup>	5 m			
	MR-J3ENCBL10M-A2-H <sup>*1</sup>	10 m			
	MR-J3ENCBL2M-A2-L <sup>*1</sup>	2 m			
	MR-J3ENCBL5M-A2-L <sup>*1</sup>	5 m			
	MR-J3ENCBL10M-A2-L <sup>*1</sup>	10 m			
(3) Encoder cable (Note 2) (load-side lead)	MR-J3JCBL03M-A1-L <sup>*1</sup>	0.3 m	IP20	For HG-KN (junction type)	Encoder connector    Junction connector 
(4) Encoder cable (Note 2) (opposite to load-side lead)	MR-J3JCBL03M-A2-L <sup>*1</sup>	0.3 m	IP20	For HG-KN (junction type)	Use this in combination with (5) or (6).
(5) Encoder cable (Note 2)	MR-EKCBL20M-H <sup>*1</sup>	20 m	IP20	For HG-KN (junction type)	Junction connector    Servo amplifier connector  Use this in combination with (3) or (4).
	MR-EKCBL30M-H (Note 3) <sup>*1</sup>	30 m			
	MR-EKCBL40M-H (Note 3) <sup>*1</sup>	40 m			
	MR-EKCBL50M-H (Note 3) <sup>*1</sup>	50 m			
	MR-EKCBL20M-L <sup>*1</sup>	20 m			
	MR-EKCBL30M-L (Note 3) <sup>*1</sup>	30 m			
(6) Encoder connector set	MR-ECNM	-	IP20	For HG-KN (junction type)	Junction connector    Servo amplifier connector  Use this in combination with (3) or (4).  Applicable cable Wire size: 0.3 mm <sup>2</sup> (AWG 22) Cable OD: 8.2 mm Crimping tool (91529-1) is required.
(7) Encoder cable (Note 2) (load-side lead)	MR-J3JSCBL03M-A1-L <sup>*1</sup>	0.3 m	IP65 (Note 4)	For HG-KN (junction type)	Encoder connector    Junction connector 
(8) Encoder cable (Note 2) (opposite to load-side lead)	MR-J3JSCBL03M-A2-L <sup>*1</sup>	0.3 m	IP65 (Note 4)	For HG-KN (junction type)	Use this in combination with (9) or (10).

Notes: 1. The IP rating indicated is for the connector's protection against ingress of dust and water when coupled to a servo amplifier/servo motor. If the IP rating of the servo amplifier/servo motor differs from that of these connectors, overall IP rating depends on the lowest of all.

2. -H and -L indicate a bending life. -H indicates a long bending life, and -L indicates a standard bending life.

3. This encoder cable is available in four-wire type. Parameter setting is required to use the four-wire type encoder cable. Refer to relevant Servo Amplifier Instruction Manual for details.

4. The encoder cable is rated IP65 while the junction connector itself is rated IP67.

For unlisted lengths

\*1. For unlisted lengths of the cables, please contact Mitsubishi Electric System &amp; Service Co., Ltd. OVERSEAS BUSINESS PROMOTION DIVISION (Email: osb.webmaster@melsc.jp)

## Cables and Connectors for Servo Motor Encoder

Refer to "Details of Optional Cables and Connectors for Servo Motors" in this catalog for the detailed models.

Item	Model	Cable length	IP rating (Note 1)	Application	Description
(9) Encoder cable (Note 2)	MR-J3ENSCBL2M-H <sup>*1</sup>	2 m	IP67	For HG-KN (junction type) For HG-SN (direct connection type)	Junction connector or encoder connector      Servo amplifier connector  Use this in combination with (7) or (8) for HG-KN series.
	MR-J3ENSCBL5M-H <sup>*1</sup>	5 m			
	MR-J3ENSCBL10M-H <sup>*1</sup>	10 m			
	MR-J3ENSCBL20M-H <sup>*1</sup>	20 m			
	MR-J3ENSCBL30M-H <sup>*1</sup>	30 m			
	MR-J3ENSCBL40M-H <sup>*1</sup>	40 m			
	MR-J3ENSCBL50M-H <sup>*1</sup>	50 m			
	MR-J3ENSCBL2M-L <sup>*1</sup>	2 m			
	MR-J3ENSCBL5M-L <sup>*1</sup>	5 m			
	MR-J3ENSCBL10M-L <sup>*1</sup>	10 m			
	MR-J3ENSCBL20M-L <sup>*1</sup>	20 m			
MR-J3ENSCBL30M-L <sup>*1</sup>	30 m				
(10) Encoder connector set (Note 5) (one-touch connection type)	MR-J3SCNS	-	IP67	For HG-KN (junction type) For HG-SN (direct connection type) (straight type)	Junction connector or encoder connector      Servo amplifier connector  Use this in combination with (7) or (8) for HG-KN series.  Applicable cable Wire size: 0.5 mm <sup>2</sup> (AWG 20) or smaller Cable OD: 5.5 mm to 9.0 mm (Note 3)
(11) Encoder connector set (Note 4, 5) (screw type)	MR-ENCNS2 <sup>*2</sup>	-	IP67	For HG-SN (direct connection type) (straight type)	Encoder connector      Servo amplifier connector  Applicable cable Wire size: 0.5 mm <sup>2</sup> (AWG 20) or smaller Cable OD: 5.5 mm to 9.0 mm (Note 3)
(12) Encoder connector set (Note 5) (one-touch connection type)	MR-J3SCNSA <sup>*2</sup>	-	IP67	For HG-SN (angle type)	Encoder connector      Servo amplifier connector  Applicable cable Wire size: 0.5 mm <sup>2</sup> (AWG 20) or smaller Cable OD: 5.5 mm to 9.0 mm (Note 3)
(13) Encoder connector set (Note 4, 5) (screw type)	MR-ENCNS2A <sup>*2</sup>	-	IP67		Encoder connector      Servo amplifier connector  Applicable cable Wire size: 0.5 mm <sup>2</sup> (AWG 20) or smaller Cable OD: 5.5 mm to 9.0 mm (Note 3)

- Notes: 1. The IP rating indicated is for the connector's protection against ingress of dust and water when coupled to a servo amplifier/servo motor. If the IP rating of the servo amplifier/servo motor differs from that of these connectors, overall IP rating depends on the lowest of all.  
 2. -H and -L indicate a bending life. -H indicates a long bending life, and -L indicates a standard bending life.  
 3. Cable clamps and bushings for cable OD of 5.5 mm to 7.5 mm and of 7.0 mm to 9.0 mm are included in the set.  
 4. A screw thread is cut on the encoder connector of HG-SN series, and the screw type connector can be used.  
 5. The connector contains a plug and contacts. Using contractors for other plugs may damage the connector. Be sure to use the enclosed contacts.

For unlisted lengths and fabricating cables

- \*1. For unlisted lengths of the cables, please contact Mitsubishi Electric System & Service Co., Ltd. OVERSEAS BUSINESS PROMOTION DIVISION (Email: osb.webmaster@melsc.jp)  
 \*2. For fabricating encoder cables with these connectors, please contact Mitsubishi Electric System & Service Co., Ltd. OVERSEAS BUSINESS PROMOTION DIVISION (Email: osb.webmaster@melsc.jp)

## Cables and Connectors for Servo Motor Power

Refer to "Details of Optional Cables and Connectors for Servo Motors" in this catalog for the detailed models.

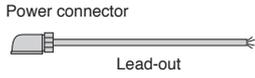
Item	Model	Cable length	IP rating (Note 1)	Application	Description
(14) Power cable (Note 2) (load-side lead)	MR-PWS1CBL2M-A1-H <sup>*1</sup>	2 m	IP65	For HG-KN (direct connection type)	 <p>Power connector Lead-out</p>
	MR-PWS1CBL5M-A1-H <sup>*1</sup>	5 m			
	MR-PWS1CBL10M-A1-H <sup>*1</sup>	10 m			
	MR-PWS1CBL2M-A1-L <sup>*1 (Note 3)</sup>	2 m			
	MR-PWS1CBL5M-A1-L <sup>*1 (Note 3)</sup>	5 m			
	MR-PWS1CBL10M-A1-L <sup>*1 (Note 3)</sup>	10 m			
(15) Power cable (Note 2) (opposite to load-side lead)	MR-PWS1CBL2M-A2-H <sup>*1</sup>	2 m	IP65	For HG-KN (direct connection type)	<p>* The cable is not shielded.</p>
	MR-PWS1CBL5M-A2-H <sup>*1</sup>	5 m			
	MR-PWS1CBL10M-A2-H <sup>*1</sup>	10 m			
	MR-PWS1CBL2M-A2-L <sup>*1 (Note 3)</sup>	2 m			
	MR-PWS1CBL5M-A2-L <sup>*1 (Note 3)</sup>	5 m			
	MR-PWS1CBL10M-A2-L <sup>*1 (Note 3)</sup>	10 m			
(16) Power cable (Note 2) (load-side lead)	MR-PWS2CBL03M-A1-L	0.3 m	IP55	For HG-KN (junction type)	 <p>Power connector Lead-out</p>
(17) Power cable (Note 2) (opposite to load-side lead)	MR-PWS2CBL03M-A2-L	0.3 m	IP55	For HG-KN (junction type)	<p>* The cable is not shielded.</p>
(18) Power connector set	MR-PWCNS4 <sup>*2</sup>	-	IP67	For HG-SN52J, 102J, 152J	 <p>Power connector</p> <p>Applicable cable Wire size: 2 mm<sup>2</sup> to 3.5 mm<sup>2</sup> (AWG 14 to 12) Cable OD: 10.5 mm to 14.1 mm</p>
(19) Power connector set	MR-PWCNS5 <sup>*2</sup>	-	IP67	For HG-SN202J, 302J	 <p>Power connector</p> <p>Applicable cable Wire size: 5.5 mm<sup>2</sup> to 8 mm<sup>2</sup> (AWG 10 to 8) Cable OD: 12.5 mm to 16 mm</p>

Notes: 1. The IP rating indicated is for the connector's protection against ingress of dust and water when coupled to a servo amplifier/servo motor. If the IP rating of the servo amplifier/servo motor differs from that of these connectors, overall IP rating depends on the lowest of all.  
 2. -H and -L indicate a bending life. -H indicates a long bending life, and -L indicates a standard bending life.  
 3. Shielded power cable MR-PWS3CBL\_M-A\_-L is also available. Contact your local sales office.

For unlisted lengths and fabricating cables

\*1. For unlisted lengths of the cables, please contact Mitsubishi Electric System & Service Co., Ltd. OVERSEAS BUSINESS PROMOTION DIVISION (Email: osb.webmaster@melsc.jp)  
 \*2. For fabricating power cables and electromagnetic brake cables, please contact Mitsubishi Electric System & Service Co., Ltd. OVERSEAS BUSINESS PROMOTION DIVISION (Email: osb.webmaster@melsc.jp)

## Cables and Connectors for Servo Motor Electromagnetic Brake

Refer to "Details of Optional Cables and Connectors for Servo Motors" in this catalog for the detailed models.

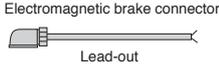
Item	Model	Cable length	IP rating (Note 1)	Application	Description
(20) Electromagnetic brake cable (Note 2) (load-side lead)	MR-BKS1CBL2M-A1-H <sup>*1</sup>	2 m	IP65	For HG-KN (direct connection type)	 Electromagnetic brake connector Lead-out
	MR-BKS1CBL5M-A1-H <sup>*1</sup>	5 m			
	MR-BKS1CBL10M-A1-H <sup>*1</sup>	10 m			
	MR-BKS1CBL2M-A1-L <sup>*1</sup>	2 m			
	MR-BKS1CBL5M-A1-L <sup>*1</sup>	5 m			
	MR-BKS1CBL10M-A1-L <sup>*1</sup>	10 m			
(21) Electromagnetic brake cable (Note 2) (opposite to load-side lead)	MR-BKS1CBL2M-A2-H <sup>*1</sup>	2 m	IP65	For HG-KN (direct connection type)	* The cable is not shielded.
	MR-BKS1CBL5M-A2-H <sup>*1</sup>	5 m			
	MR-BKS1CBL10M-A2-H <sup>*1</sup>	10 m			
	MR-BKS1CBL2M-A2-L <sup>*1</sup>	2 m			
	MR-BKS1CBL5M-A2-L <sup>*1</sup>	5 m			
	MR-BKS1CBL10M-A2-L <sup>*1</sup>	10 m			
(22) Electromagnetic brake cable (Note 2) (load-side lead)	MR-BKS2CBL03M-A1-L	0.3 m	IP55	For HG-KN (junction type)	Electromagnetic brake connector  Lead-out * The cable is not shielded.
(23) Electromagnetic brake cable (Note 2) (opposite to load-side lead)	MR-BKS2CBL03M-A2-L	0.3 m	IP55	For HG-KN (junction type)	* The cable is not shielded.
(24) Electromagnetic brake connector set (Note 4) (one-touch connection type)	MR-BKCNS1 <sup>*2</sup>	-	IP67	For HG-SN (straight type)	Electromagnetic brake connector 
(25) Electromagnetic brake connector set (Note 3, 4) (screw type)	MR-BKCNS2 <sup>*2</sup>	-	IP67		Applicable cable Wire size: 1.25 mm <sup>2</sup> (AWG 16) or smaller Cable OD: 9.0 mm to 11.6 mm
(26) Electromagnetic brake connector set (Note 4) (one-touch connection type)	MR-BKCNS1A <sup>*2</sup>	-	IP67	For HG-SN (angle type)	Electromagnetic brake connector 
(27) Electromagnetic brake connector set (Note 3, 4) (screw type)	MR-BKCNS2A <sup>*2</sup>	-	IP67		Applicable cable Wire size: 1.25 mm <sup>2</sup> (AWG 16) or smaller Cable OD: 9.0 mm to 11.6 mm

- Notes: 1. The IP rating indicated is for the connector's protection against ingress of dust and water when coupled to a servo amplifier/servo motor. If the IP rating of the servo amplifier/servo motor differs from that of these connectors, overall IP rating depends on the lowest of all.  
 2. -H and -L indicate a bending life. -H indicates a long bending life, and -L indicates a standard bending life.  
 3. A screw thread is cut on the encoder connector of HG-SN series, and the screw type connector can be used.  
 4. The connector contains a plug and contacts. Using contractors for other plugs may damage the connector. Be sure to use the enclosed contacts.

For unlisted lengths and fabricating cables

<p>*1. For unlisted lengths of the cables, please contact Mitsubishi Electric System &amp; Service Co., Ltd. OVERSEAS BUSINESS PROMOTION DIVISION (Email: osb.webmaster@melsc.jp)                  *2. For fabricating power cables and electromagnetic brake cables, please contact Mitsubishi Electric System &amp; Service Co., Ltd. OVERSEAS BUSINESS PROMOTION DIVISION (Email: osb.webmaster@melsc.jp)</p>
--

## Details of Optional Cables and Connectors for Servo Motors

Model	Encoder connector	Servo amplifier connector
MR-J3ENCBL_M-A1-H (Note 2) MR-J3ENCBL_M-A1-L (Note 2) MR-J3ENCBL_M-A2-H (Note 2) MR-J3ENCBL_M-A2-L (Note 2)	 2174053-1 (TE Connectivity Ltd. Company)	 Receptacle: 36210-0100PL Shell kit: 36310-3200-008 (3M) or Connector set: 54599-1019 (Molex)

Model	Encoder connector	Junction connector
MR-J3JCBLO3M-A1-L (Note 2) MR-J3JCBLO3M-A2-L (Note 2)	 2174053-1 (TE Connectivity Ltd. Company)	 Contact: 1473226-1 (with ring) Housing: 1-172169-9 Cable clamp: 316454-1 (TE Connectivity Ltd. Company)

Model	Junction connector	Servo amplifier connector
MR-EKCBL_M-H MR-EKCBL_M-L MR-ECNM	 Housing: 1-172161-9 Connector pin: 170359-1 (TE Connectivity Ltd. Company) or an equivalent product Cable clamp: MTI-0002 (Toa Electric Industrial Co., Ltd.)	 Receptacle: 36210-0100PL Shell kit: 36310-3200-008 (3M) or Connector set: 54599-1019 (Molex)

Model	Encoder connector	Junction connector
MR-J3JSCBLO3M-A1-L (Note 2) MR-J3JSCBLO3M-A2-L (Note 2)	 2174053-1 (TE Connectivity Ltd. Company)	 Cable receptacle: CM10-CR10P-M (DDK Ltd.)

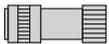
Model	Encoder connector	Servo amplifier connector
MR-J3ENSABL_M-H (Note 2) MR-J3ENSABL_M-L (Note 2)	 For 10 m or shorter cable Straight plug: CMV1-SP10S-M1 Socket contact: CMV1-#22ASC-C1-100 For 20 m or longer cable Straight plug: CMV1-SP10S-M1 (long bending life) CMV1-SP10S-M2 (standard) Socket contact: CMV1-#22ASC-C2-100 (DDK Ltd.)	 Receptacle: 36210-0100PL Shell kit: 36310-3200-008 (3M) or Connector set: 54599-1019 (Molex)

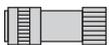
Model	Junction connector/encoder connector	Servo amplifier connector
MR-J3SCNS (Note 2, 3)	 Straight plug: CMV1-SP10S-M2 (Note 1) Socket contact: CMV1-#22ASC-S1-100 (DDK Ltd.)	 Receptacle: 36210-0100PL Shell kit: 36310-3200-008 (3M) or Connector set: 54599-1019 (Molex)

Notes: 1. Cable clamps and bushings for cable OD of 5.5 mm to 7.5 mm and of 7.0 mm to 9.0 mm are included in the set.

2. The cable or the connector set may contain different connectors but still usable.

3. The connector contains a plug and contacts. Using contractors for other plugs may damage the connector. Be sure to use the enclosed contacts.



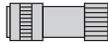

## Details of Optional Cables and Connectors for Servo Motors

Model	Encoder connector	Servo amplifier connector
MR-ENCNS2 (Note 3)	 Straight plug: CMV1S-SP10S-M2 (Note 1) Socket contact: CMV1-#22ASC-S1-100 (DDK Ltd.)	 Receptacle: 36210-0100PL Shell kit: 36310-3200-008 (3M) or Connector set: 54599-1019 (Molex)

Model	Encoder connector	Servo amplifier connector
MR-J3SCNSA (Note 2, 3)	 Angle plug: CMV1-AP10S-M2 (Note 1) Socket contact: CMV1-#22ASC-S1-100 (DDK Ltd.)	 Receptacle: 36210-0100PL Shell kit: 36310-3200-008 (3M) or Connector set: 54599-1019 (Molex)

Model	Encoder connector	Servo amplifier connector
MR-ENCNS2A (Note 3)	 Angle plug: CMV1S-AP10S-M2 (Note 1) Socket contact: CMV1-#22ASC-S1-100 (DDK Ltd.)	 Receptacle: 36210-0100PL Shell kit: 36310-3200-008 (3M) or Connector set: 54599-1019 (Molex)

Model	Power connector
MR-PWS1CBL_M-A1-H (Note 2) MR-PWS1CBL_M-A1-L (Note 2) MR-PWS1CBL_M-A2-H (Note 2) MR-PWS1CBL_M-A2-L (Note 2)	 Plug: KN4FT04SJ1-R Socket contact: ST-TMH-S-C1B-100-(A534G) (Japan Aviation Electronics Industry, Limited)

Model	Power connector
MR-PWS2CBL03M-A1-L (Note 2) MR-PWS2CBL03M-A2-L (Note 2)	 Plug: KN4FT04SJ2-R Socket contact: ST-TMH-S-C1B-100-(A534G) (Japan Aviation Electronics Industry, Limited)

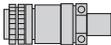
Model	Power connector
MR-PWCNS4	 Plug: CE05-6A18-10SD-D-BSS (straight) Cable clamp: CE3057-10A-1-D (DDK Ltd.)

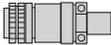
Model	Power connector
MR-PWCNS5	 Plug: CE05-6A22-22SD-D-BSS (straight) Cable clamp: CE3057-12A-1-D (DDK Ltd.)

- Notes: 1. Cable clamps and bushings for cable OD of 5.5 mm to 7.5 mm and of 7.0 mm to 9.0 mm are included in the set.  
 2. The cable or the connector set may contain different connectors but still usable.  
 3. The connector contains a plug and contacts. Using contractors for other plugs may damage the connector. Be sure to use the enclosed contacts.

## Details of Optional Cables and Connectors for Servo Motors

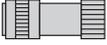
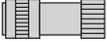
Model	Electromagnetic brake connector	
MR-BKS1CBL_M-A1-H MR-BKS1CBL_M-A1-L MR-BKS1CBL_M-A2-H MR-BKS1CBL_M-A2-L		Plug: JN4FT02SJ1-R Socket contact: ST-TMH-S-C1B-100-(A534G) (Japan Aviation Electronics Industry, Limited)
MR-BKS2CBL03M-A1-L MR-BKS2CBL03M-A2-L		Plug: JN4FT02SJ2-R Socket contact: ST-TMH-S-C1B-100-(A534G) (Japan Aviation Electronics Industry, Limited)
MR-BKCNS1 (Note 1, 2)		Straight plug: CMV1-SP2S-L Socket contact: CMV1-#22BSC-S2-100 (DDK Ltd.)
MR-BKCNS2 (Note 2)		Straight plug: CMV1S-SP2S-L Socket contact: CMV1-#22BSC-S2-100 (DDK Ltd.)
MR-BKCNS1A (Note 1, 2)		Angle plug: CMV1-AP2S-L Socket contact: CMV1-#22BSC-S2-100 (DDK Ltd.)
MR-BKCNS2A (Note 2)		Angle plug: CMV1S-AP2S-L Socket contact: CMV1-#22BSC-S2-100 (DDK Ltd.)

Notes: 1. The cable or the connector set may contain different connectors but still usable.

2. The connector contains a plug and contacts. Using contractors for other plugs may damage the connector. Be sure to use the enclosed contacts.

## Products on the Market for Servo Motors

Contact the relevant manufacturers directly.

When fabricating a cable with the following connectors, refer to the relevant manufacturers' instruction manuals for wiring and assembling procedures.



### Encoder connector (servo amplifier-side)

Application	Connector (3M)
Servo amplifier CN2 connector	Receptacle: 36210-0100PL Shell kit: 36310-3200-008
	Connector (Molex)
	54599-1019 (gray) 54599-1016 (black)

### Encoder connector for HG-KN series



Applicable servo motor	Feature (Note 1)	Connector (TE Connectivity Ltd. Company)	Crimping tools (TE Connectivity Ltd. Company)	Applicable cable example
HG-KN	IP65	2174053-1	For ground clip: 1596970-1 For receptacle contact: 1596847-1	Wire size: 0.13 mm <sup>2</sup> to 0.33 mm <sup>2</sup> (AWG 26 to 22) Cable OD: 6.8 mm to 7.4 mm Wire example: Fluorine resin wire (Vinyl jacket cable TPE. SVP 70/0.08(AWG#22)-3P KB-2237-2 Bando Densen Co., Ltd. (Note 2) or an equivalent product)

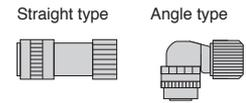

### Encoder connector for HG-SN series

Applicable servo motor	Feature (Note 1)	Connector (DDK Ltd.)				Applicable cable example Cable OD [mm]
		Type	Type of connection	Plug	Socket contact	
HG-SN	IP67	Straight	One-touch connection type	CMV1-SP10S-M1	Select from solder or press bonding type. (Refer to the table below.)	5.5 to 7.5
				CMV1-SP10S-M2		7.0 to 9.0
			Screw type	CMV1S-SP10S-M1		5.5 to 7.5
				CMV1S-SP10S-M2		7.0 to 9.0
		Angle	One-touch connection type	CMV1-AP10S-M1		5.5 to 7.5
				CMV1-AP10S-M2		7.0 to 9.0
			Screw type	CMV1S-AP10S-M1		5.5 to 7.5
				CMV1S-AP10S-M2		7.0 to 9.0

Contact	Socket contact (DDK Ltd.)	Wire size (Note 3)
Solder type	CMV1-#22ASC-S1-100	0.5 mm <sup>2</sup> (AWG 20) or smaller
Press bonding type	CMV1-#22ASC-C1-100	0.2 mm <sup>2</sup> to 0.5 mm <sup>2</sup> (AWG 24 to 20) Crimping tool (357J-53162T) is required.
	CMV1-#22ASC-C2-100	0.08 mm <sup>2</sup> to 0.2 mm <sup>2</sup> (AWG 28 to 24) Crimping tool (357J-53163T) is required.

Notes: 1. The IP rating indicated is for the connector's protection against ingress of dust and water when coupled to a servo amplifier/servo motor. If the IP rating of the servo amplifier/servo motor differs from that of these connectors, overall IP rating depends on the lowest of all.

2. Contact Toa Electric Industrial Co., Ltd.

3. The wire size shows wiring specification of the connector.

## Products on the Market for Servo Motors

Contact the relevant manufacturers directly.

When fabricating a cable with the following connectors, refer to the relevant manufacturers' instruction manuals for wiring and assembling procedures.

### Power connector for HG-KN series



Applicable servo motor	Feature (Note 1)	Connector (Japan Aviation Electronics Industry, Limited)	Crimping tools (Japan Aviation Electronics Industry, Limited)	Applicable cable example
HG-KN	IP65	Plug: KN4FT04SJ1-R Socket contact: ST-TMH-S-C1B-100-(A534G)	For contactor: CT160-3-TMH5B	Wire size: 0.3 mm <sup>2</sup> to 0.75 mm <sup>2</sup> (AWG 22 to 18) Cable OD: 5.3 mm to 6.5 mm Wire example: Fluorine resin wire (Vinyl jacket cable RMFES-A (CL3X) AWG 19, 4 cores Dyden Corporation (Note 4) or an equivalent product)

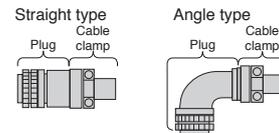

### Power connector for HG-SN series

Applicable servo motor	Feature (Note 1)	Plug (with backshell) (DDK Ltd.)		Cable clamp (DDK Ltd.)	Applicable cable example	
		Type	Model	Model	Wire size (Note 3)	Cable OD [mm]
HG-SN52J, 102J, 152J	IP67 EN compliant	Straight	CE05-6A18-10SD-D-BSS	CE3057-10A-2-D	2.2 mm <sup>2</sup> to 3.5 mm <sup>2</sup> (AWG 14 to 12)	8.5 to 11
	CE3057-10A-1-D			10.5 to 14.1		
General environment (Note 2)	D/MS3106B18-10S		D/MS3057-10A	2.2 mm <sup>2</sup> to 3.5 mm <sup>2</sup> (AWG 14 to 12)	14.3 or smaller (bushing ID)	
	HG-SN202J, 302J		IP67 EN compliant	CE05-6A22-22SD-D-BSS	CE3057-12A-2-D	5.5 mm <sup>2</sup> to 8 mm <sup>2</sup> (AWG 10 to 8)
General environment (Note 2)		D/MS3106B22-22S	D/MS3057-12A		12.5 to 16	
	HG-SN52J, 102J, 152J	IP67 EN compliant	Angle	CE05-8A18-10SD-D-BAS	CE3057-10A-2-D	2.2 mm <sup>2</sup> to 3.5 mm <sup>2</sup> (AWG 14 to 12)
General environment (Note 2)		CE3057-10A-1-D			10.5 to 14.1	
	HG-SN202J, 302J	IP67 EN compliant		CE05-8A22-22SD-D-BAS	CE3057-12A-2-D	5.5 mm <sup>2</sup> to 8 mm <sup>2</sup> (AWG 10 to 8)
General environment (Note 2)		D/MS3108B18-10S			D/MS3057-10A	
	HG-SN202J, 302J	IP67 EN compliant	D/MS3108B22-22S	D/MS3057-12A	5.5 mm <sup>2</sup> to 8 mm <sup>2</sup> (AWG 10 to 8)	15.9 or smaller (bushing ID)
General environment (Note 2)		D/MS3108B22-22S		D/MS3057-12A	5.5 mm <sup>2</sup> to 8 mm <sup>2</sup> (AWG 10 to 8)	15.9 or smaller (bushing ID)

Notes: 1. The IP rating indicated is for the connector's protection against ingress of dust and water when coupled to a servo amplifier/servo motor. If the IP rating of the servo amplifier/servo motor differs from that of these connectors, overall IP rating depends on the lowest of all.

2. Not compliant with EN.

3. The wire size shows wiring specification of the connector. Refer to "Selection Example in HIV Wires for Servo Motors" in this catalog for examples of wire size selection.

4. Contact Taisei Co., Ltd.

## Products on the Market for Servo Motors

Contact the relevant manufacturers directly.

When fabricating a cable with the following connectors, refer to the relevant manufacturers' instruction manuals for wiring and assembling procedures.

### Electromagnetic brake connector for HG-KN series



Applicable servo motor	Feature (Note 1)	Connector (Japan Aviation Electronics Industry, Limited)	Crimping tool (Japan Aviation Electronics Industry, Limited)	Applicable cable example
HG-KN	IP65	Plug: JN4FT02SJ1-R Socket contact: ST-TMH-S-C1B-100-(A534G)	For contactor: CT160-3-TMH5B	Wire size: 0.3 mm <sup>2</sup> to 0.5 mm <sup>2</sup> (AWG 22 to 20) Cable OD: 3.6 mm to 4.8 mm Wire example: Fluorine resin wire (Vinyl jacket cable RMFES-A (CL3X) AWG 20, 2 cores Dyden Corporation (Note 2) or an equivalent product)

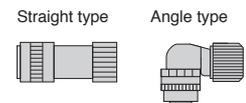

### Electromagnetic brake connector for HG-SN series

Applicable servo motor	Feature (Note 1)	Connector (DDK Ltd.)				Applicable cable example Cable OD [mm]
		Type	Type of connection	Plug	Socket contact	
HG-SN	IP67	Straight	One-touch connection type	CMV1-SP2S-S	Select from solder or press bonding type. (Refer to the table below.)	4.0 to 6.0
				CMV1-SP2S-M1		5.5 to 7.5
				CMV1-SP2S-M2		7.0 to 9.0
				CMV1-SP2S-L		9.0 to 11.6
			Screw type	CMV1S-SP2S-S		4.0 to 6.0
				CMV1S-SP2S-M1		5.5 to 7.5
				CMV1S-SP2S-M2		7.0 to 9.0
				CMV1S-SP2S-L		9.0 to 11.6
		Angle	One-touch connection type	CMV1-AP2S-S		4.0 to 6.0
				CMV1-AP2S-M1		5.5 to 7.5
				CMV1-AP2S-M2		7.0 to 9.0
				CMV1-AP2S-L		9.0 to 11.6
			Screw type	CMV1S-AP2S-S		4.0 to 6.0
				CMV1S-AP2S-M1		5.5 to 7.5
				CMV1S-AP2S-M2		7.0 to 9.0
				CMV1S-AP2S-L		9.0 to 11.6

Contact	Socket contact (DDK Ltd.)	Wire size (Note 3)
Solder type	CMV1-#22BSC-S2-100	1.25 mm <sup>2</sup> (AWG 16) or smaller
Press bonding type	CMV1-#22BSC-C3-100	0.5 mm <sup>2</sup> to 1.25 mm <sup>2</sup> (AWG 20 to 16) Crimping tool (357J-53164T) is required.

Notes: 1. The IP rating indicated is for the connector's protection against ingress of dust and water when coupled to a servo amplifier/servo motor. If the IP rating of the servo amplifier/servo motor differs from that of these connectors, overall IP rating depends on the lowest of all.

2. Contact Taisei Co., Ltd.

3. The wire size shows wiring specification of the connector. Refer to "Selection Example in HIV Wires for Servo Motors" in this catalog for examples of wire size selection.

Configuration Example for MR-JE-B (Note 2)

B

1 kW or smaller

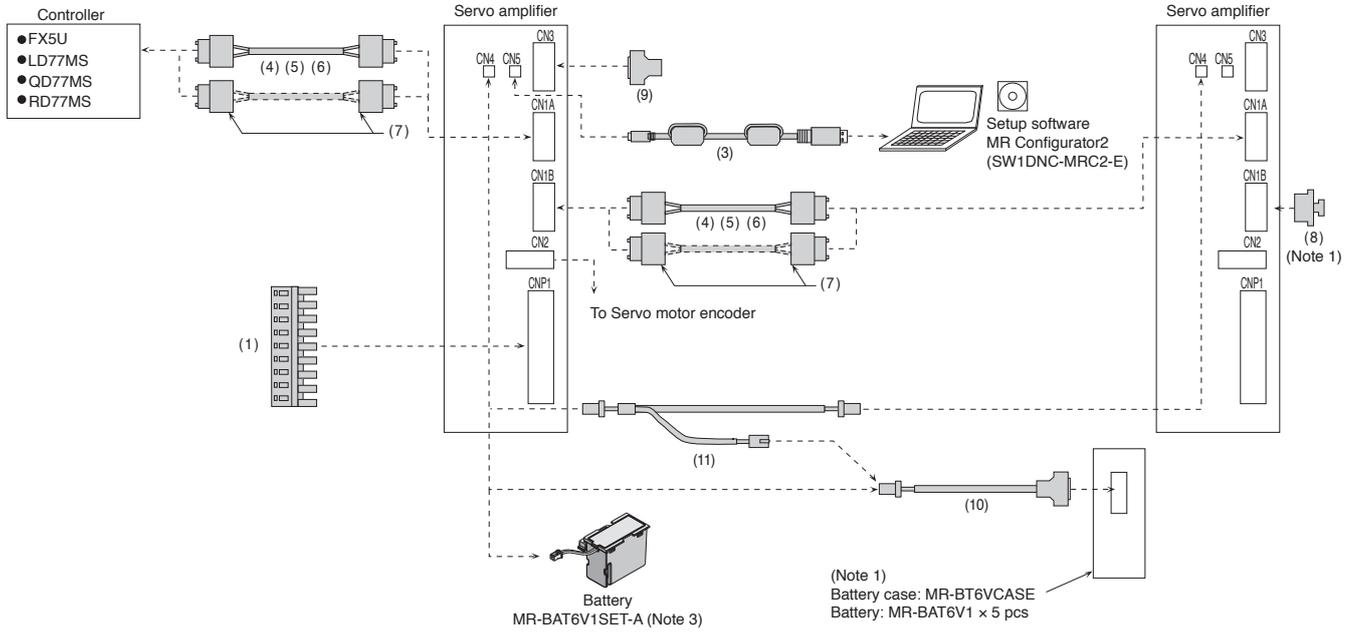

2 kW and 3 kW

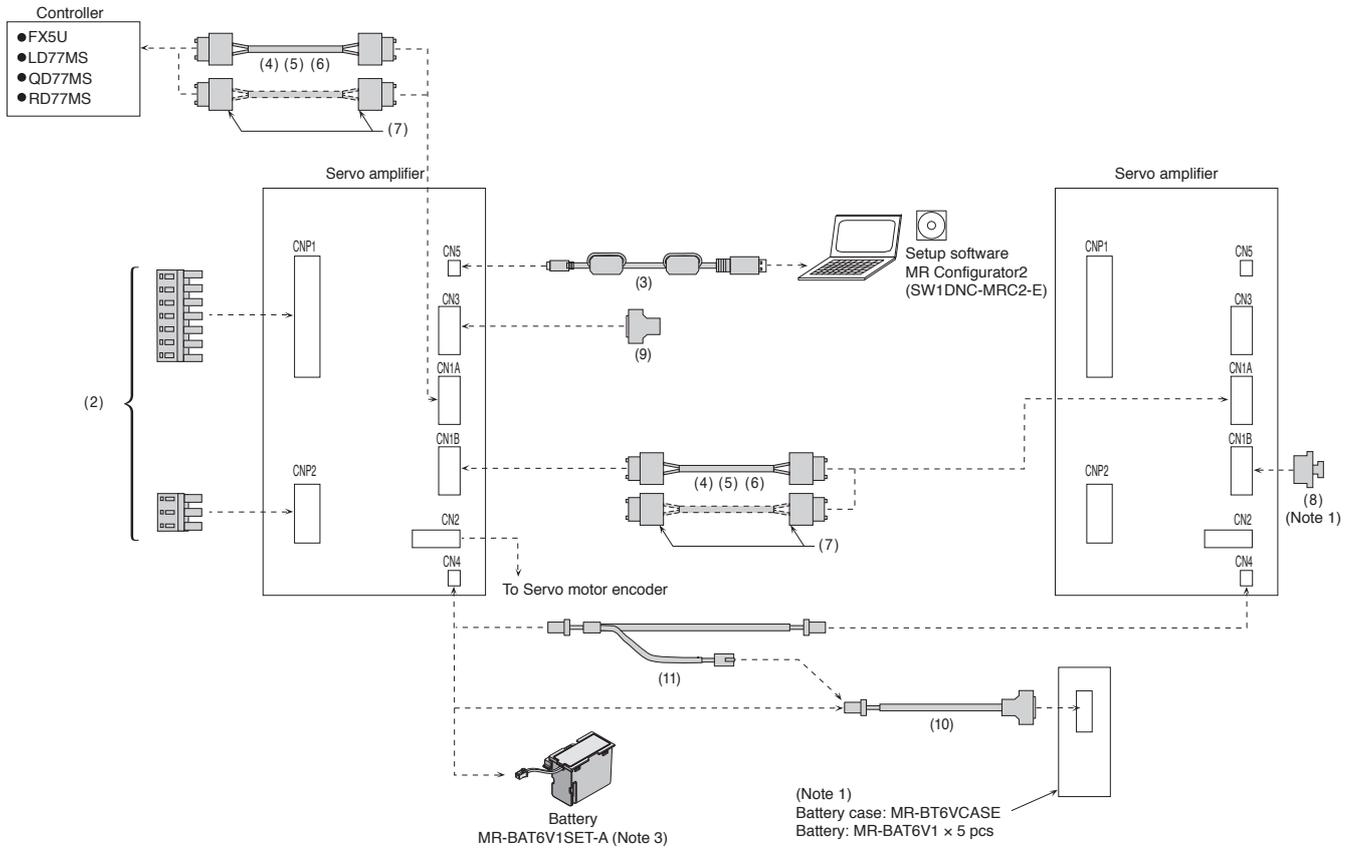

Notes: 1. Refer to "Battery Case and Battery" in this catalog. MR-BT6VCASE and MR-BAT6V1 are not required when configuring incremental system with the MR-JE-B servo amplifier.

2. Cables drawn with dashed lines need to be fabricated by user. Refer to relevant Servo Amplifier Instruction Manual for fabricating the cables.

3. Refer to "Battery" in this catalog. MR-BAT6V1SET-A is not required when configuring incremental system with the MR-JE-B servo amplifier.

## Cables and Connectors for MR-JE-B

B

Refer to "Details of Optional Cables and Connectors for Servo Amplifiers" in this catalog for the detailed models.

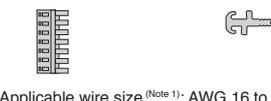
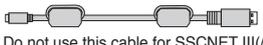
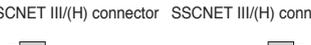
	Item	Model	Cable length	IP rating	Application	Description
For CNP1	(1) Servo amplifier CNP1 power connector (Note 2) (insertion type)	MR-JECNP1-01	-	-	For MR-JE-100B or smaller	 <p>CNP1 connector      Open tool</p> <p>Applicable wire size (Note 1): AWG 18 to 14 Insulator OD: up to 3.9 mm</p>
	(2) Servo amplifier CNP1 power connector (Note 2) (insertion type)	MR-JECNP1-02	-	-	For MR-JE-200B/ MR-JE-300B	 <p>CNP1 connector      Open tool</p> <p>Applicable wire size (Note 1): AWG 16 to 10 Insulator OD: up to 4.7 mm</p>
For CNP1/CNP2	Servo amplifier CNP2 power connector (Note 2) (insertion type)	MR-JECNP2-02	-	-		
	(3) Personal computer communication cable (USB cable)	MR-J3USBCBL3M	3 m	-	For MR-JE-B	 <p>Servo amplifier connector mini-B connector (5-pin)      Personal computer connector A connector</p> <p>* Do not use this cable for SSCNET III(H) compatible controller.</p>
For controller/CN1A/CN1B	(4) SSCNET III cable (Note 3) (standard cord inside cabinet) Compatible with SSCNET III(H)	MR-J3BUS015M	0.15 m	-	For MR-JE-B	 <p>SSCNET III(H) connector      SSCNET III(H) connector</p>
		MR-J3BUS03M	0.3 m	-		
		MR-J3BUS05M	0.5 m	-		
		MR-J3BUS1M	1 m	-		
		MR-J3BUS3M	3 m	-		
	(5) SSCNET III cable (Note 3) (standard cable outside cabinet) Compatible with SSCNET III(H)	MR-J3BUS5M-A <sup>*1</sup>	5 m	-	For MR-JE-B	
		MR-J3BUS10M-A <sup>*1</sup>	10 m	-		
		MR-J3BUS20M-A <sup>*1</sup>	20 m	-		
	(6) SSCNET III cable (Note 3, 5) (long distance cable, long bending life) Compatible with SSCNET III(H)	MR-J3BUS30M-B <sup>*1</sup>	30 m	-	For MR-JE-B	
		MR-J3BUS40M-B <sup>*1</sup>	40 m	-		
	MR-J3BUS50M-B <sup>*1</sup>	50 m	-			
(7) SSCNET III connector set (Note 3, 4) Compatible with SSCNET III(H)	MR-J3BCN1	-	-	For MR-JE-B	 <p>SSCNET III(H) connector      SSCNET III(H) connector</p>	
For CN1B	(8) SSCNET III connector cap Compatible with SSCNET III(H)	(Standard accessory)	-	-	For MR-JE-B	

- Notes: 1. The wire size shows wiring specification of the connector. Refer to "Selection Example in HIV Wires for Servo Motors" in this catalog for examples of wire size selection.  
2. CNP1 and CNP2 connectors, and open tool are supplied with the servo amplifier.  
3. Read carefully through the precautions enclosed with the options before use.  
4. Dedicated tools are required. Contact your local sales office for more details.  
5. When SSCNET III/H is used, refer to "Products on the Market for Servo Amplifiers" in this catalog for cables over 50 m or with ultra-long bending life.

For unlisted lengths

\*1. For unlisted lengths of the cables, please contact Mitsubishi Electric System & Service Co., Ltd. OVERSEAS BUSINESS PROMOTION DIVISION (Email: osb.webmaster@melsc.jp)

Servo Amplifiers

Servo Motors

Options/Peripheral  
Equipment

LVS/Wires

Product List

Cautions

## Cables and Connectors for MR-JE-B

B

Refer to "Details of Optional Cables and Connectors for Servo Amplifiers" in this catalog for the detailed models.

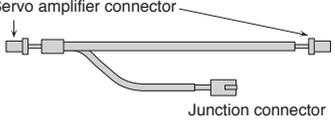
	Item	Model	Cable length	IP rating	Application	Description
For CN3	(9) Connector set	MR-CCN1	-	-	For MR-JE-B	 Servo amplifier connector
	For CN4	(10) Battery cable	MR-BT6V1CBL03M	0.3 m	-	For connecting MR-JE-B and MR-BT6VCASE
MR-BT6V1CBL1M			1 m			
(11) Junction battery cable		MR-BT6V2CBL03M	0.3 m	-	For MR-JE-B	
		MR-BT6V2CBL1M	1 m			



## Configuration Example for MR-JE-A (Note 2)

A

1 kW or smaller

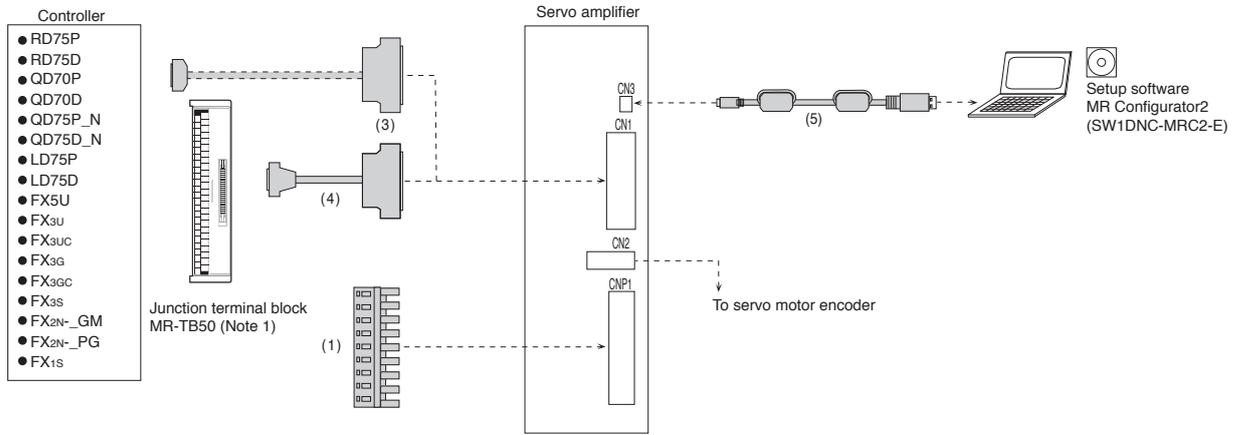

2 kW and 3 kW

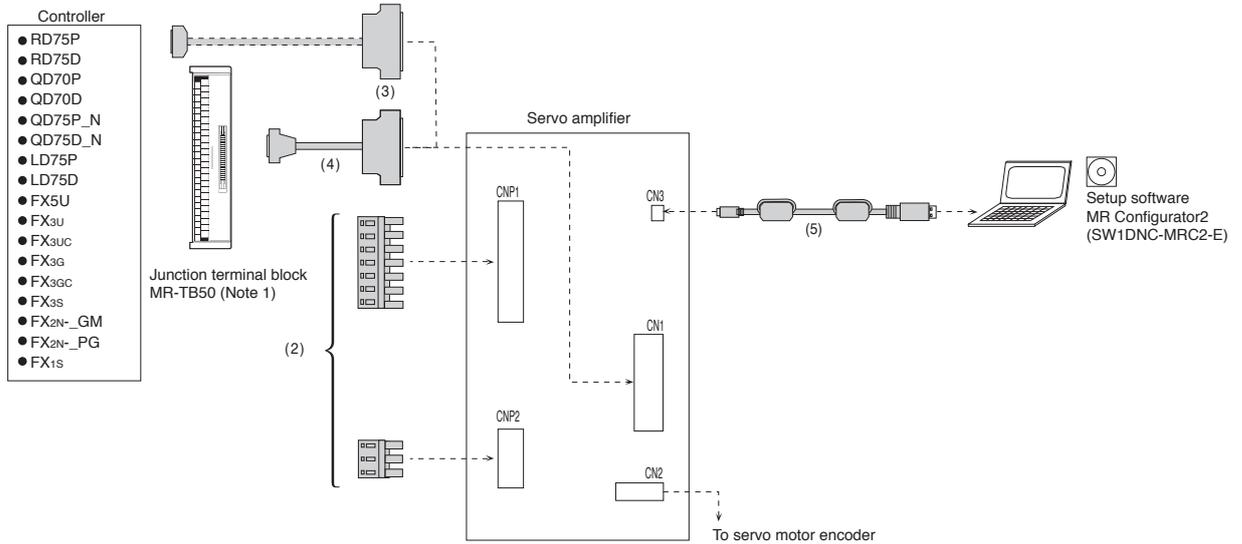

Notes: 1. Refer to "Junction Terminal Block" in this catalog.

2. Cables drawn with dashed lines need to be fabricated by user. Refer to relevant Servo Amplifier Instruction Manual for fabricating the cables.

## Cables and Connectors for MR-JE-A

Refer to "Details of Optional Cables and Connectors for Servo Amplifiers" in this catalog for the detailed models.

	Item	Model	Cable length	IP rating	Application	Description
For CNP1	(1) Servo amplifier CNP1 power connector <sup>(Note 2)</sup> (insertion type)	MR-JECNP1-01	-	-	For MR-JE-100A or smaller	<p>CNP1 connector  Open tool </p> <p>Applicable wire size <sup>(Note 1)</sup>: AWG 18 to 14 Insulator OD: up to 3.9 mm</p>
For CNP1/CNP2	(2) Servo amplifier CNP1 power connector <sup>(Note 2)</sup> (insertion type)	MR-JECNP1-02	-	-	For MR-JE-200A/ MR-JE-300A	<p>CNP1 connector  Open tool </p> <p>Applicable wire size <sup>(Note 1)</sup>: AWG 16 to 10 Insulator OD: up to 4.7 mm</p>
	Servo amplifier CNP2 power connector <sup>(Note 2)</sup> (insertion type)	MR-JECNP2-02	-	-		<p>CNP2 connector </p> <p>Applicable wire size <sup>(Note 1)</sup>: AWG 16 to 10 Insulator OD: up to 4.7 mm</p>
For CN1	(3) Connector set	MR-J3CN1	-	-	For MR-JE-A	<p> Servo amplifier connector</p>
	(4) Junction terminal block cable	MR-J2M-CN1TBL05M MR-J2M-CN1TBL1M	0.5 m 1 m	-	For connecting MR-JE-A and MR-TB50	<p>Junction terminal block connector  Servo amplifier connector </p>
For CN3	(5) Personal computer communication cable (USB cable)	MR-J3USBCBL3M	3 m	-	For MR-JE-A	<p>Servo amplifier connector mini-B connector (5-pin)  Personal computer connector A connector </p>

Notes: 1. The wire size shows wiring specification of the connector. Refer to "Selection Example in HIV Wires for Servo Motors" in this catalog for examples of wire size selection.  
2. CNP1 and CNP2 connectors, and open tool are supplied with the servo amplifier.

## Details of Optional Cables and Connectors for Servo Amplifiers

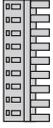
Model	CNP1 connector	Open tool
MR-JECNP1-01 (Note 2)	 09JFAT-SAXGDK-H5.0 (J.S.T. Mfg. Co., Ltd.)	 J-FAT-OT (J.S.T. Mfg. Co., Ltd.)

Model	CNP1 connector	Open tool
MR-JECNP1-02 (Note 2)	 07JFAT-SAXGFS-XL (J.S.T. Mfg. Co., Ltd.)	 J-FAT-OT-EXL (J.S.T. Mfg. Co., Ltd.)

Model	CNP2 connector
MR-JECNP2-02 (Note 2)	 03JFAT-SAXGFK-XL (J.S.T. Mfg. Co., Ltd.)

Model	SSCNET III(/H) connector	SSCNET III(/H) connector
MR-J3BUS_M MR-J3BUS_M-A MR-J3BCN1	 Connector: PF-2D103 (Japan Aviation Electronics Industry, Limited)	 Connector: PF-2D103 (Japan Aviation Electronics Industry, Limited)

Model	SSCNET III(/H) connector	SSCNET III(/H) connector
MR-J3BUS_M-B	 Connector: CF-2D103-S (Japan Aviation Electronics Industry, Limited)	 Connector: CF-2D103-S (Japan Aviation Electronics Industry, Limited)

Model	Servo amplifier connector
MR-CCN1	 Solder type (Note 3) Connector: 10120-3000PE Shell kit: 10320-52F0-008 (3M) or an equivalent product

Model	Servo amplifier connector
MR-J3CN1	 Connector: 10150-3000PE Shell kit: 10350-52F0-008 (3M) or an equivalent product

Model	Junction terminal block connector	Servo amplifier connector
MR-J2M-CN1TBL_M	 Connector: D7950-B500FL (3M)	 Press bonding type (Note 1) Connector: 10150-6000EL Shell kit: 10350-3210-000 (3M)

Notes: 1. Solder type (connector: 10150-3000PE and shell kit: 10350-52F0-008) (3M) is also usable. Contact the manufacturer directly.  
 2. CNP1 and CNP2 connectors, and an open tool are supplied with the servo amplifier.  
 3. Press bonding type (connector: 10120-6000EL, shell kit: 10320-3210-000) (3M) is also usable. Contact the manufacture directly.

## Details of Optional Cables and Connectors for Servo Motors

Model	Servo amplifier connector	Battery case connector
MR-BT6V1CBL_M	 Contact: SPHD-001G-P0.5 Housing: PAP-02V-0 (J.S.T. Mfg. Co., Ltd.)	 Solder type <sup>(Note 1)</sup> Connector: 10114-3000PE Shell kit: 10314-52F0-008 (3M) or an equivalent product

Model	Servo amplifier connector	Junction connector
MR-BT6V2CBL_M	 Contact: SPHD-001G-P0.5 Housing: PAP-02V-0 (J.S.T. Mfg. Co., Ltd.)	 Contact: SPAL-001GU-P0.5 Housing: PALR-02VF-O (J.S.T. Mfg. Co., Ltd.)

Notes: 1. Press bonding type (connector: 10140-6000EL and shell kit: 10314-3210-000) (3M) is also usable. Contact the manufacturer directly.

## Products on the Market for Servo Amplifiers

### SSCNET III cable

**B**

Application	Model	Description
Ultra-long bending life fiber-optic cable for SSCNET III(/H)	SC-J3BUS_M-C _ = cable length (100 m max. <sup>(Note 1)</sup> , unit of 1 m)	 Mitsubishi Electric System & Service Co., Ltd.

Notes: 1. The maximum wiring distance between stations is 100 m for SSCNET III/H and 50 m for SSCNET III.

## Application of connecting encoder junction cable

Unlisted lengths of cables between servo amplifier and servo motor, EMC cables, and special cables for connecting servo amplifier and servo motor with multiple cables are available. Please contact Mitsubishi Electric System & Service Co., Ltd. OVERSEAS BUSINESS PROMOTION DIVISION (Email: [osb.webmaster@melsc.jp](mailto:osb.webmaster@melsc.jp))

Example) Configuration using three encoder junction cables

- Replacing only the cable of the moving part in the cable chain is possible.
- Resetting after transporting a machine is easy because the servo amplifier side and the servo motor side can be separated.

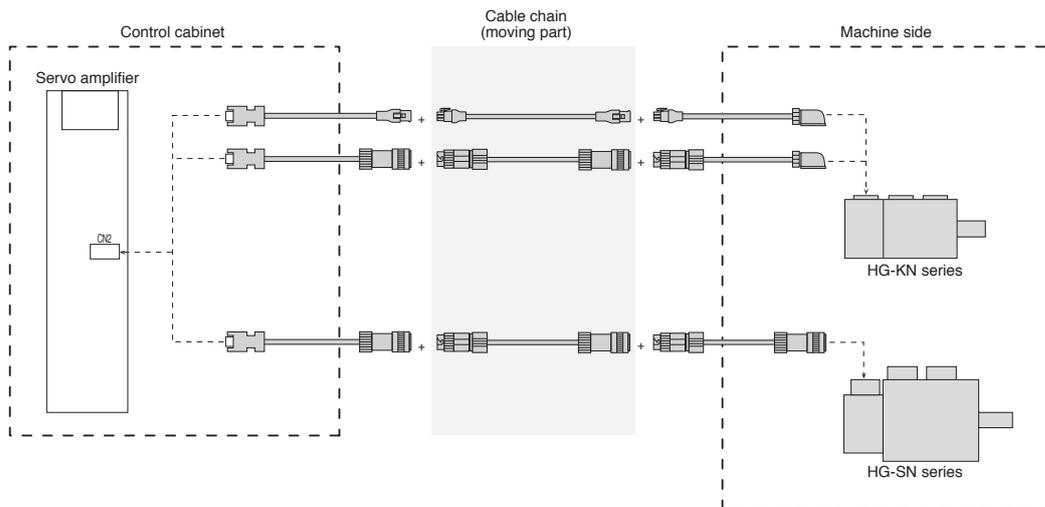

## Regenerative Option

**B** **A**

Servo amplifier model	Built-in regenerative resistor	Tolerable regenerative power [W]				
		Regenerative option <sup>(Note 2)</sup>				
		MR-RB032	MR-RB12	MR-RB30	MR-RB32	MR-RB50 <sup>(Note 1)</sup>
		40 Ω	40 Ω	13 Ω	40 Ω	13 Ω
MR-JE-10B/A	-	30	-	-	-	-
MR-JE-20B/A	-	30	100	-	-	-
MR-JE-40B/A	10	30	100	-	-	-
MR-JE-70B/A	20	30	100	-	300	-
MR-JE-100B/A	20	30	100	-	300	-
MR-JE-200B/A	100	-	-	300	-	500
MR-JE-300B/A	100	-	-	300	-	500

Notes: 1. Be sure to cool the unit forcibly with a cooling fan (92 mm × 92 mm, minimum air flow: 1.0 m<sup>3</sup>/min). The cooling fan must be prepared by user.  
 2. The power values in this table are resistor-generated powers, not rated powers.

### \* Cautions when connecting the regenerative option

1. The regenerative option causes a temperature rise of 100 °C or higher relative to the ambient temperature. Fully examine heat dissipation, installation position, wires used before installing the unit. Use flame-retardant wires or apply flame retardant on wires, and keep the wires clear of the unit.
2. Use twisted wires for connecting the regenerative option to the servo amplifier, and keep the wire length to a maximum of 5 m.
3. Use twisted wires for connecting a thermal sensor, and make sure that the sensor does not fail to work properly due to inducted noise.



### Battery (MR-BAT6V1SET-A) (Note1)

B

The absolute position data can be retained by mounting the battery on the servo amplifier. MR-BAT6V1SET-A is reusable by replacing the built-in MR-BAT6V1 batteries.

MR-BAT6V1SET-A is not required for the incremental system.

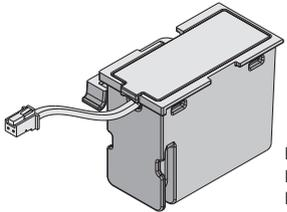
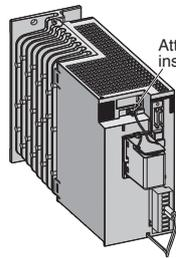
Appearance	Mounting method
 <p>Model: MR-BAT6V1SET-A Nominal voltage: 6 V Nominal capacity: 1650 mAh Lithium content: 1.2 g Primary battery: 2CR17335A Mass: 55 g</p>	 <p>Attach the battery, and then insert the plug to CN4 connector.</p> <p>* MR-J3BAT battery cannot be used because of the difference in voltage.</p>

Notes: 1. MR-BAT6V1SET-A is an assembled battery composed of lithium metal batteries of CR17335A. This battery is not subject to the dangerous goods (Class 9) of the UN Recommendations. To transport lithium metal batteries and lithium metal batteries contained in equipment by means of transport subject to the UN Recommendations, take actions to comply with the following regulations: the United Nations Recommendations on the Transport of Dangerous Goods, the Technical Instruction (ICAO-TI) by the International Civil Aviation Organization (ICAO), and the International Maritime Dangerous Goods Code (IMDG Code) by the International Maritime Organization (IMO). To transport the batteries, check the latest standards or the laws of the destination country and take actions. Contact your local sales office for more details.

### Battery Case (MR-BT6VCASE ), Battery (MR-BAT6V1) (Note 1)

B

Absolute position data of up to eight axes of the servo motors can be retained by using the battery case and the batteries. The servo motors used in incremental system are also included in the number of the connectable axes.

The case stores five batteries by connecting to the connectors. The batteries are not included in the battery case. Please purchase the batteries separately.

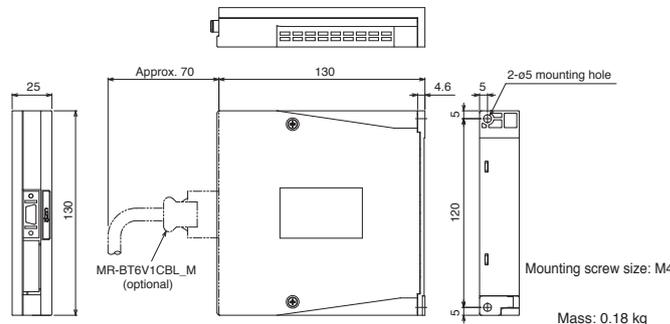
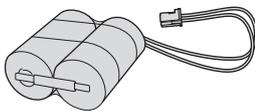
Dimensions (assembled)	MR-BAT6V1
 <p>[Unit: mm]</p> <p>Mass: 0.18 kg</p>	 <p>Model: MR-BAT6V1 Nominal voltage: 6 V Nominal capacity: 1650 mAh Lithium content: 1.2 g Primary battery: 2CR17335A Mass: 34 g</p>

Notes: 1. MR-BAT6V1 is an assembled battery composed of lithium metal batteries of CR17335A. This battery is not subject to the dangerous goods (Class 9) of the UN Recommendations. To transport lithium metal batteries and lithium metal batteries contained in equipment by means of transport subject to the UN Recommendations, take actions to comply with the following regulations: the United Nations Recommendations on the Transport of Dangerous Goods, the Technical Instruction (ICAO-TI) by the International Civil Aviation Organization (ICAO), and the International Maritime Dangerous Goods Code (IMDG Code) by the International Maritime Organization (IMO). To transport the batteries, check the latest standards or the laws of the destination country and take actions. Contact your local sales office for more details.

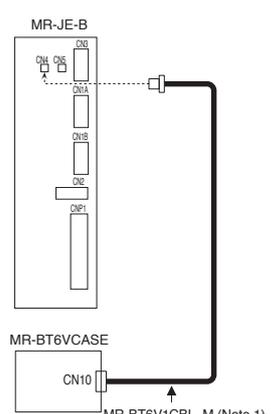
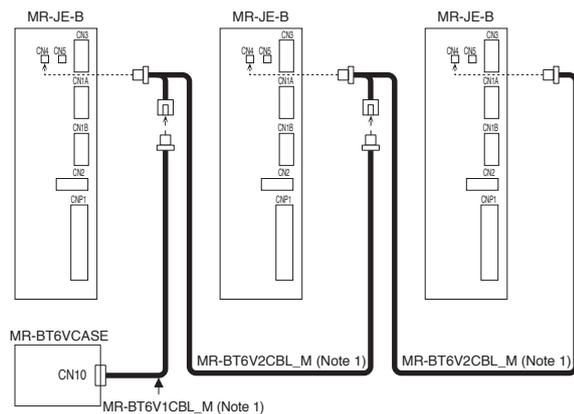
Connections	
<p>For connecting to one unit of servo amplifier</p> 	<p>For connecting up to eight servo amplifier axes</p> 

Notes: 1. This is an optional cable. Refer to "Cables and Connectors for Servo Amplifiers" in this catalog.

### Junction Terminal Block (MR-TB50)

A

Connect all signals via the junction terminal block.

Dimensions	[Unit: mm]
	<p>Terminal screw size: M3.5                  Applicable wire: 2 mm<sup>2</sup> maximum                  Crimping terminal width: 7.2 mm or shorter                  Mounting screw size: M4</p>

### Radio Noise Filter (FR-BIF)

B A

This filter suppresses noise from the power supply side of the servo amplifier, especially effective for the radio frequency bands of 10 MHz or lower. The FR-BIF is designed to be installed on the input side.

Dimensions	[Unit: mm]	Connections
		<p>Do not use the FR-BIF on the output side of the servo amplifier. Wiring should be as short as possible, and grounding is required. Be sure to insulate the unused wire when using the FR-BIF with a 1-phase power supply.</p>

### Line Noise Filter (FR-BSF01)

B A

This filter suppresses radio noise from the power supply side and the output side of the servo amplifier. The FR-BSF01 is also effective in suppressing high-frequency leakage current (zero-phase current), especially the range of 0.5 MHz and 5 MHz.

Dimensions	[Unit: mm]	Connections
		<p>This line noise filter is installable on the wires for the power supply (L1, L2, and L3) to the servo amplifier and the power supply (U, V, and W) to the servo motor. Pass each of the wires through the line noise filter equal times in a same direction.</p> <p>For the power supply, the effect of the filter rises as the number of passes increases, but generally four passes would be appropriate. For the servo motor power, passes must be four times or less. Do not pass the grounding wire through the filter. Otherwise, the effect of the filter is reduced.</p> <p>Wind the wires to pass through the filter as the required number of passes as shown in Fig.1. If the wires are too thick to wind, use two or more filters to have the required number of passes as shown in Fig.2.</p> <p>Place the line noise filters as close to the servo amplifier as possible for their best performance.</p> <div style="display: flex; justify-content: space-around;"> <div style="text-align: center;"> <p>Fig. 1</p> </div> <div style="text-align: center;"> <p>Fig. 2</p> </div> </div>

### Data Line Filter

B A

This filter is effective in preventing noise when attached to the pulse output cable of the pulse train output controller or the motor encoder cable.

Example) ESD-SR-250 (manufactured by NEC TOKIN Corporation)  
 ZCAT3035-1330 (manufactured by TDK)  
 GRFC-13 (manufactured by Kitagawa Industries Co., Ltd.)

### Surge Killer

B A

Attach surge killers to AC relays and AC valves around the servo amplifier. Attach diodes to DC relays and DC valves.

Example) Surge killer: CR-50500 (manufactured by Okaya Electric Industries Co., Ltd.)  
 Diode: A diode with breakdown voltage four or more times greater than the relay drive voltage, and with current capacity two or more times greater than the relay drive current.



## EMC Filter

**B A**

The following filters are recommended as a filter compliant with the EMC directive for the power supply of the servo amplifier.

Servo amplifier model	EMC filter model <sup>(Note 2)</sup>	Rated current [A]	Rated voltage [V AC]	Fig.
MR-JE-10B/A to 100B/A	HF3010A-UN <sup>(Note 1)</sup>	10	250	A
MR-JE-200B/A, 300B/A	HF3030A-UN <sup>(Note 1)</sup>	30	250	B

Notes: 1. Manufactured by Soshin Electric Co., Ltd.

A surge protector is separately required to use this EMC filter. Refer to "EMC Installation Guidelines."

2. When using the EMC filter, install one EMC filter for each servo amplifier.

	Dimensions <span style="float: right;">[Unit: mm]</span>	Connections						
<b>A</b>	<p><b>HF3010A-UN</b></p> <table border="1" style="margin-top: 10px;"> <thead> <tr> <th>Model</th> <th>Leakage current [mA]</th> <th>Mass [kg]</th> </tr> </thead> <tbody> <tr> <td>HF3010A-UN</td> <td>5</td> <td>3.5</td> </tr> </tbody> </table>	Model	Leakage current [mA]	Mass [kg]	HF3010A-UN	5	3.5	<p>For 3-phase 200 V AC</p> <p>For 1-phase 200 V AC (1 kW or smaller)</p>
Model	Leakage current [mA]	Mass [kg]						
HF3010A-UN	5	3.5						
<b>B</b>	<p><b>HF3030A-UN</b></p> <table border="1" style="margin-top: 10px;"> <thead> <tr> <th>Model</th> <th>Leakage current [mA]</th> <th>Mass [kg]</th> </tr> </thead> <tbody> <tr> <td>HF3030A-UN</td> <td>5</td> <td>5.5</td> </tr> </tbody> </table>	Model	Leakage current [mA]	Mass [kg]	HF3030A-UN	5	5.5	<p>For 1-phase 200 V AC (2 kW)</p>
Model	Leakage current [mA]	Mass [kg]						
HF3030A-UN	5	5.5						

## Power Factor Improving AC Reactor (FR-HAL)

This boosts the power factor of servo amplifier and reduces the power supply capacity.

Servo amplifier model	Power factor improving AC reactor model <sup>(Note 1)</sup>	Fig.
MR-JE-10B/A	FR-HAL-0.4K	A
MR-JE-20B/A		
MR-JE-40B/A		
MR-JE-70B/A		
MR-JE-100B/A (3-phase power supply input)	FR-HAL-2.2K	B
MR-JE-100B/A (1-phase power supply input)		
MR-JE-200B/A (3-phase power supply input)		
MR-JE-200B/A (1-phase power supply input)		
MR-JE-300B/A		

Notes: 1. When using the power factor improving AC reactor, install one reactor for each servo amplifier.

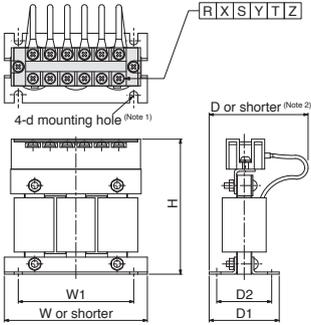
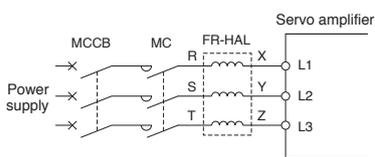
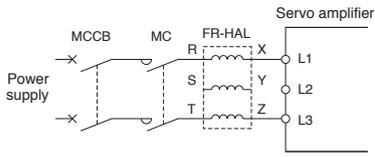
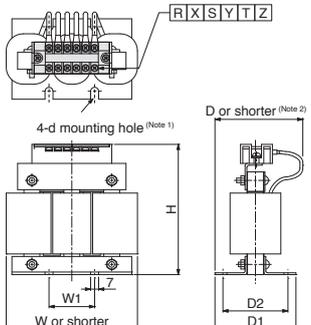
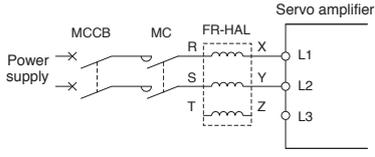
	Dimensions <span style="float: right;">[Unit: mm]</span>	Connections																																																			
A	 <table border="1" style="margin-top: 10px;"> <thead> <tr> <th rowspan="2">Model</th> <th colspan="7">Variable dimensions</th> </tr> <tr> <th>W</th> <th>W1</th> <th>H</th> <th>D</th> <th>D1</th> <th>D2</th> <th>d</th> </tr> </thead> <tbody> <tr> <td>FR-HAL-0.4K</td> <td>104±2</td> <td>84</td> <td>99</td> <td>72</td> <td>51</td> <td>40</td> <td>M5</td> </tr> <tr> <td>FR-HAL-0.75K</td> <td>104±2</td> <td>84</td> <td>99</td> <td>74</td> <td>56</td> <td>44</td> <td>M5</td> </tr> <tr> <td>FR-HAL-1.5K</td> <td>104±2</td> <td>84</td> <td>99</td> <td>77</td> <td>61</td> <td>50</td> <td>M5</td> </tr> </tbody> </table> <table border="1" style="margin-top: 10px;"> <thead> <tr> <th>Model</th> <th>Mass [kg]</th> <th>Terminal screw size</th> </tr> </thead> <tbody> <tr> <td>FR-HAL-0.4K</td> <td>0.6</td> <td>M4</td> </tr> <tr> <td>FR-HAL-0.75K</td> <td>0.8</td> <td>M4</td> </tr> <tr> <td>FR-HAL-1.5K</td> <td>1.1</td> <td>M4</td> </tr> </tbody> </table>	Model	Variable dimensions							W	W1	H	D	D1	D2	d	FR-HAL-0.4K	104±2	84	99	72	51	40	M5	FR-HAL-0.75K	104±2	84	99	74	56	44	M5	FR-HAL-1.5K	104±2	84	99	77	61	50	M5	Model	Mass [kg]	Terminal screw size	FR-HAL-0.4K	0.6	M4	FR-HAL-0.75K	0.8	M4	FR-HAL-1.5K	1.1	M4	<p>For 3-phase 200 V AC</p>  <p>For 1-phase 200 V AC (1 kW or smaller)</p> 
Model	Variable dimensions																																																				
	W	W1	H	D	D1	D2	d																																														
FR-HAL-0.4K	104±2	84	99	72	51	40	M5																																														
FR-HAL-0.75K	104±2	84	99	74	56	44	M5																																														
FR-HAL-1.5K	104±2	84	99	77	61	50	M5																																														
Model	Mass [kg]	Terminal screw size																																																			
FR-HAL-0.4K	0.6	M4																																																			
FR-HAL-0.75K	0.8	M4																																																			
FR-HAL-1.5K	1.1	M4																																																			
B	 <table border="1" style="margin-top: 10px;"> <thead> <tr> <th rowspan="2">Model</th> <th colspan="7">Variable dimensions</th> </tr> <tr> <th>W</th> <th>W1</th> <th>H</th> <th>D</th> <th>D1</th> <th>D2</th> <th>d</th> </tr> </thead> <tbody> <tr> <td>FR-HAL-2.2K</td> <td>115</td> <td>40</td> <td>115</td> <td>77</td> <td>71</td> <td>57</td> <td>M6</td> </tr> <tr> <td>FR-HAL-3.7K</td> <td>115</td> <td>40</td> <td>115</td> <td>83</td> <td>81</td> <td>67</td> <td>M6</td> </tr> <tr> <td>FR-HAL-5.5K</td> <td>115</td> <td>40</td> <td>115</td> <td>83</td> <td>81</td> <td>67</td> <td>M6</td> </tr> </tbody> </table> <table border="1" style="margin-top: 10px;"> <thead> <tr> <th>Model</th> <th>Mass [kg]</th> <th>Terminal screw size</th> </tr> </thead> <tbody> <tr> <td>FR-HAL-2.2K</td> <td>1.5</td> <td>M4</td> </tr> <tr> <td>FR-HAL-3.7K</td> <td>2.2</td> <td>M4</td> </tr> <tr> <td>FR-HAL-5.5K</td> <td>2.3</td> <td>M4</td> </tr> </tbody> </table>	Model	Variable dimensions							W	W1	H	D	D1	D2	d	FR-HAL-2.2K	115	40	115	77	71	57	M6	FR-HAL-3.7K	115	40	115	83	81	67	M6	FR-HAL-5.5K	115	40	115	83	81	67	M6	Model	Mass [kg]	Terminal screw size	FR-HAL-2.2K	1.5	M4	FR-HAL-3.7K	2.2	M4	FR-HAL-5.5K	2.3	M4	<p>For 1-phase 200 V AC (2 kW)</p> 
Model	Variable dimensions																																																				
	W	W1	H	D	D1	D2	d																																														
FR-HAL-2.2K	115	40	115	77	71	57	M6																																														
FR-HAL-3.7K	115	40	115	83	81	67	M6																																														
FR-HAL-5.5K	115	40	115	83	81	67	M6																																														
Model	Mass [kg]	Terminal screw size																																																			
FR-HAL-2.2K	1.5	M4																																																			
FR-HAL-3.7K	2.2	M4																																																			
FR-HAL-5.5K	2.3	M4																																																			

Notes: 1. Use this mounting hole for grounding.

2. This indicates the maximum dimension. The dimension varies depending on the bending degree of the input/output line.

## Servo Support Software

### Capacity selection software (MRZJW3-MOTSZ111E)

**B** **A**

#### Specifications

Item		Description
Types of machine component		Horizontal ball screws, vertical ball screws, rack and pinions, roll feeds, rotating tables, carts, elevators, conveyors, other (direct inertia input) devices
Output of results	Item	Servo amplifier, servo motor, regenerative option, moment of inertia of load, load to motor inertia ratio, peak torque, peak torque ratio, effective torque, effective torque ratio, regenerative power, regenerative power ratio
	Printing	Prints entered specifications, operating pattern, calculation process, graph of selection process feed speed (or motor speed) and torque, and sizing results.
	Data saving	Entered specifications, operating patterns and sizing results are saved with a file name.
Moment of inertia calculation function		Cylinder, square block, variable speed, linear movement, hanging, conical, conical base

#### System requirements

IBM PC/AT compatible model running with the following requirements.

Components		Capacity selection software (MRZJW3-MOTSZ111E) (Note 1)
Personal computer (Note 2)	OS (Note 3) (English version)	Microsoft® Windows® 8.1 Enterprise Operating System Microsoft® Windows® 8.1 Pro Operating System Microsoft® Windows® 8.1 Operating System Microsoft® Windows® 8 Enterprise Operating System Microsoft® Windows® 8 Pro Operating System Microsoft® Windows® 8 Operating System Microsoft® Windows® 7 Enterprise Operating System Microsoft® Windows® 7 Ultimate Operating System Microsoft® Windows® 7 Professional Operating System Microsoft® Windows® 7 Home Premium Operating System Microsoft® Windows® 7 Starter Operating System Microsoft® Windows Vista® Enterprise Operating System Microsoft® Windows Vista® Ultimate Operating System Microsoft® Windows Vista® Business Operating System Microsoft® Windows Vista® Home Premium Operating System Microsoft® Windows Vista® Home Basic Operating System Microsoft® Windows® XP Professional Operating System Microsoft® Windows® XP Home Edition Operating System Microsoft® Windows® 2000 Professional Operating System Microsoft® Windows® Millennium Edition Operating System Microsoft® Windows® 98 Second Edition Operating System Microsoft® Windows® 98 Operating System
	CPU	Pentium® 133 MHz or more (Windows® 98, Windows® 2000) Pentium® 150 MHz or more (Windows® Millennium Edition) Pentium® 300 MHz or more (Windows® XP) 1 GHz or more 32-bit (x86) processor (Windows Vista®) 1 GHz or more 32-bit (x86) or 64-bit (x64) processor (Windows® 7, Windows® 8, Windows® 8.1)
	Memory	24 MB or more (Windows® 98) 32 MB or more (Windows® Millennium Edition, Windows® 2000) 128 MB or more (Windows® XP) 1 GB or more (Windows Vista®, Windows® 7, Windows® 8, Windows® 8.1)
	Free hard disk space	40 MB or more
Browser		Windows® Internet Explorer® 4.0 or later
Monitor		Resolution 800 × 600 or more, 16-bit high color, Compatible with above personal computers.
Keyboard		Compatible with above personal computers.
Mouse		Compatible with above personal computers.
Printer		Compatible with above personal computers.
Communication cable		Not required

Notes: 1. Software version C6 or later is compatible with MR-JE-A. Software version D2 or later is compatible with MR-JE-B.  
2. This software may not run correctly, depending on a personal computer being used.  
3. For 64-bit operating system, this software is compatible with Windows® 7 or later.

## Servo Support Software

B

A



## MR Configurator2 (SW1DNC-MRC2-E)

MR Configurator2 can be obtained by either of the following:

- Purchase MR Configurator2 alone.
- Purchase MT Works2: MR Configurator2 is included in MT Works2 with software version 1.34L or later.
- Download MR Configurator2: If you have GX Works2 or MT Works2 with software version earlier than 1.34L, you can download MR Configurator2 from website free of charge.

## Specifications

Item	Description
Project	New/Open/Close/Save/Save As/Delete Project, System Setting, Print
Parameter	Parameter Setting, Axis Name Setting <sup>(Note 2)</sup> , Parameter Converter <sup>(Note 2)</sup>
Positioning data <sup>(Note 2)</sup>	Point Table, Program, Indirect Addressing, Cam Data
Monitor	Display All, I/O Monitor, Graph, ABS Data Display <sup>(Note 1)</sup>
Diagnosis	Alarm Display, Alarm Onset Data, Drive Recorder, No Motor Rotation, System Configuration, Life Diagnosis, Machine Diagnosis
Test mode	JOG Mode, Positioning Mode, Motor-Less Operation, DO Forced Output, Program Operation, Test Mode Information
Adjustment	One-touch Tuning, Tuning, Machine Analyzer
Others	Servo Assistant, Update Parameter Setting Range, Machine Unit Conversion Setting <sup>(Note 1)</sup> , Switch Display Language, Help

Notes: 1. Available only with MR-JE-\_B.

2. Available only with MR-JE-\_A.

## System requirements

IBM PC/AT compatible model running with the following requirements.

Components		MR Configurator2 <sup>(Note 3)</sup>
Personal computer <sup>(Note 1)</sup>	OS <sup>(Note 2)</sup>	Microsoft® Windows® 8.1 Enterprise Operating System
		Microsoft® Windows® 8.1 Pro Operating System
		Microsoft® Windows® 8.1 Operating System
		Microsoft® Windows® 8 Enterprise Operating System
		Microsoft® Windows® 8 Pro Operating System
		Microsoft® Windows® 8 Operating System
		Microsoft® Windows® 7 Enterprise Operating System
		Microsoft® Windows® 7 Ultimate Operating System
		Microsoft® Windows® 7 Professional Operating System
		Microsoft® Windows® 7 Home Premium Operating System
Microsoft® Windows® 7 Starter Operating System		
Microsoft® Windows Vista® Enterprise Operating System		
Microsoft® Windows Vista® Ultimate Operating System		
Microsoft® Windows Vista® Business Operating System		
Microsoft® Windows Vista® Home Premium Operating System		
Microsoft® Windows Vista® Home Basic Operating System		
Microsoft® Windows® XP Professional Operating System, Service Pack 2 or later		
Microsoft® Windows® XP Home Edition Operating System, Service Pack 2 or later		
CPU (recommended)	Desktop PC: Intel® Celeron® processor 2.8 GHz or more Laptop PC: Intel® Pentium® M processor 1.7 GHz or more	
Memory (recommended)	512 MB or more (32-bit OS), 1 GB or more (64-bit OS)	
Free hard disk space	1 GB or more	
Communication interface	Use USB port	
Browser	Windows® Internet Explorer® 4.0 or later	
Monitor	Resolution 1024 × 768 or more, 16-bit high color, Compatible with above personal computers.	
Keyboard	Compatible with above personal computers.	
Mouse	Compatible with above personal computers.	
Printer	Compatible with above personal computers.	
Communication cable	MR-J3USBCBL3M	

Notes: 1. This software may not run correctly, depending on a personal computer being used.

2. For 64-bit operating system, this software is compatible with Windows® 7 or later.

3. Software version 1.19V or later is compatible with MR-JE-A, and 1.34L or later with MR-JE-B.

# 4

Features of Low-Voltage Switchgear .....	4-1
Wires, Molded-Case Circuit Breakers and Magnetic Contactors .....	4-4
Selection Example in HIV Wires for Servo Motors .....	4-4

## Low-Voltage Switchgear/Wires

## Mitsubishi Molded Case Circuit Breakers and Earth Leakage Circuit Breakers WS-V Series

"WS-V Series" is the new circuit breakers that have a lot of superior aspects such as higher breaking capacity, design for easy use, standardization of accessory parts, and compliance to the global standards.

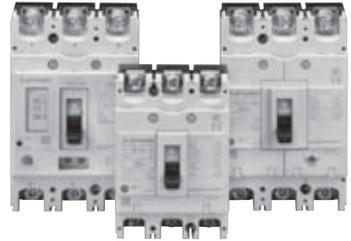

### Features

**Technologies based on long years of experience are brought together to achieve improved performance**

The new circuit breaking technology "Expanded ISTAC" has improved the current-limiting performance and upgraded the overall breaking capacity.

Expansion of the conductor under the stator shortens the contact parting time of the mover as compared to the conventional ISTAC structure.

The current-limiting performance has been improved remarkably. (The maximum peak current value has been reduced by approx. 10%.)

### Example of breaking capacity improvement



### New circuit breaking technology (Expanded ISTAC)

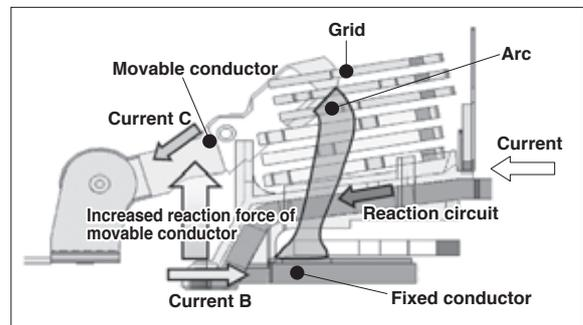

Class \ AF	32	63	125	160	250
NF-C (Economy class)	-	NF63-CV	NF125-CV	-	NF250-CV
NF-S (Standard class)	NF32-SV	NF63-SV	NF125-SV NF125-SGV NF125-SEV	NF160-SGV	NF250-SV NF250-SGV NF250-SEV
NF-L (High-performance class)	-	-	NF125-LGV	NF160-LGV	NF250-LGV
NF-H (High-performance class)	-	NF63-HV	NF125-HV NF125-HGV NF125-HEV	NF160-HGV	NF250-HV NF250-HGV NF250-HEV

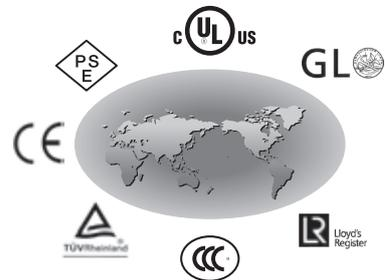

### Types of internal accessories are reduced from 3 types to 1 type

Standardization of internal accessories contributes to a reduction of stock and delivery time.



For security and standard compliance of machines, F-type and V-type operating handles are available for breakers.

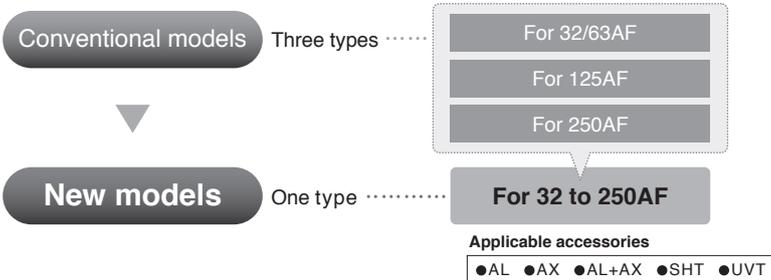

### Lineup of UL 489 listed circuit breakers for 480 V AC "High Performance"

The breaking capacity has been improved to satisfy the request for SCCR upgrading.

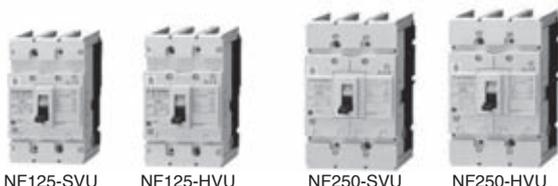

Breaking capacity of UL 489 listed circuit breakers for 480 V AC (UL 489)

- NF125-SVU/NV125-SVU: 30 kA
- NF125-HVU/NV125-HVU: 50 kA
- NF250-SVU/NV250-SVU: 35 kA
- NF250-HVU/NV250-HVU: 50 kA

## Mitsubishi Magnetic Motor Starters and Magnetic Contactors MS-T Series

MS-T series is newly released!

The MS-T series is smaller than ever, enabling more compact control panel. The MS-T series is suitable for MELSERVO-JE series as well as other Mitsubishi FA equipment. In addition, the MS-T conforms to a variety of global standards, supporting the global use.

### Features

#### Compact

**Just 36 mm wide for 10 A-frame type!**

General-purpose magnetic contactor with smallest width\* in the industry.

The width of MS-T series is reduced by 32% as compared to the prior MS-N series, enabling a more compact panel.

\*Based on Mitsubishi Electric research as of May 2014 in the general-purpose magnetic contactor industry for 10 A-frame class.



S-T10

[Unit: mm]

Frame size		11 A		13 A		20 A		25 A			
MS-N series	Front view		S-N10		S-N11 (Auxiliary 1-pole)		S-N12 (Auxiliary 2-pole)		S-N20		S-N25
New MS-T series	Front view		S-T10		S-T12 (Auxiliary 2-pole)		S-T20		S-T25		

### Standardization

#### Covers provided as standard equipment

Terminal cover and auxiliary contact unit covers are provided as standard equipment. Not only ensuring your safety, but also saving you time and cost of selecting and purchasing the covers separately.

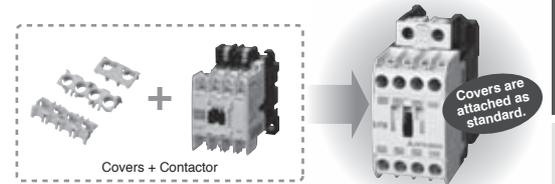

#### Wide-ranged operation coil rating

The prior series had 14 types of the operation coil rating. Owing to the wide-ranged operation coil rating, the number of the rating types for the MS-T series is reduced to half, making it easier to select as compared to the prior model.

Consolidating the number of the produced coils type allows not just the reduction of customer storage, but also shortening of delivery time.

Coil designation	Rated voltage [V]	
	50 Hz	60 Hz
AC12 V	12	12
AC24 V	24	24
AC48 V	48 to 50	48 to 50
AC100 V	100	100 to 110
AC120 V	110 to 120	115 to 120
AC127 V	125 to 127	127
AC200 V	200	200 to 220
AC220 V	208 to 220	220
AC230 V	220 to 240	230 to 240
AC260 V	240 to 260	260 to 280
AC380 V	346 to 380	380
AC400 V	380 to 415	400 to 440
AC440 V	415 to 440	460 to 480
AC500 V	500	500 to 550

Coil designation	Rated voltage [V]
	50 Hz/60 Hz
AC24 V	24
AC48 V	48 to 50
AC100 V	100 to 127
AC200 V	200 to 240
AC300 V	260 to 300
AC400 V	380 to 440
AC500 V	460 to 550

\* 12 V type is an order-made product.

### Global Standard

#### Conforms to various global standards

Not only major global standards such as IEC, JIS, UL, CE, and CCC but also ship standards and other country standards are planned to be certified.

⊙: Compliant as standard

Model	Applicable Standard				Safety Standard		EC Directive	Certification Body	CCC
	IEC	JIS	DIN/VDE	BS/EN	UL	CSA	CE Marking	TÜV	GB
	International	Japan	Germany	England Europe	U.S.A	Canada	Europe	Germany	China
S-T10 to S-T32 MSO-T10 to MSO-T25 TH-T18(KP) to TH-T25(KP)	⊙	⊙	⊙	⊙	⊙	⊙	⊙	⊙ <sup>1</sup>	⊙

<sup>1</sup>1. The Motor Starters will be certified under each type name of the Magnetic contactors and the Thermal Overload Relays on the condition that the Magnetic contactors and the Thermal Overload Relays are used in combination.

Servo Amplifiers  
Servo Motors  
Options/Peripheral Equipment  
LV/SM/Wires  
Product List  
Cautions

## Mitsubishi Magnetic Motor Starters and Magnetic Contactors MS-N Series

Environment-friendly Mitsubishi MS-N series ensures safety and conforms to various global standards. Its compact size contributes to space-saving in a machine. The MS-N series is suitable for MELSERVO-JE series as well as other Mitsubishi FA equipment and can be used globally.



S-N35CX



### Features

#### Bifurcated contact adopted to achieve high contact reliability

Contact reliability is greatly improved by combining bifurcated moving contact and stationary contact. This series responds to the various needs such as the application to safety circuit.

\* The MS-T series also has bifurcated contacts.

#### Mirror contact (auxiliary contact off at main contact welding)

The MS-N series meets requirements of "Control functions in the event of failure" described in EN 60204-1 "Electrical equipment of machines", being suitable as interlock circuit contact. The MS-N series is applicable for category 4 safety circuit. We ensure safety for our customers.

\* The MS-T series also has mirror contacts.

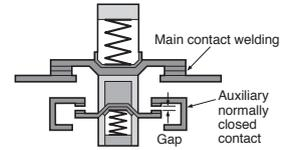

#### Various option units

Various options including surge absorbers and additional auxiliary contact blocks are available.

#### Conforms to various global standards

Ⓢ : Compliant as standard

Model	Applicable Standard				Safety Standard		EC Directive	Certification Body	CCC
	IEC	JIS	DIN/VDE	BS/EN	UL	CSA	CE Marking	TÜV	GB
	International	Japan	Germany	England Europe	U.S.A	Canada	Europe	Germany	China
S-N10 to S-N400 MSO-N10 to MSO-N400 TH-N12KP to TH-N400KP	Ⓢ	Ⓢ	Ⓢ	Ⓢ	Ⓢ	Ⓢ	Ⓢ	Ⓢ *1	Ⓢ

\*1. The Motor Starters are certified under each type name of the Magnetic contactors and the Thermal Overload Relays on the condition that the Magnetic contactors and the Thermal Overload Relays are used in combination.



## Wires, Molded-Case Circuit Breakers and Magnetic Contactors

The following are examples of wire sizes when 600 V grade heat-resistant polyvinyl chloride insulated wires (HIV wires) are used. The wire size for U, V, W, and  $\ominus$  varies depending on the servo motor. Refer to "Selection Example in HIV Wires for Servo Motors" in this catalog for details on wires for each servo motor.

Servo amplifier model	Molded-case circuit breaker (Note 4, 6)	Magnetic contactor (Note 2, 6)	Wire size [mm <sup>2</sup> ] (Note 4)		
			L1, L2, L3, $\ominus$	P+, C	U, V, W, $\ominus$
MR-JE-10B/A	30 A frame 5 A (30 A frame 5 A)	S-N10 S-T10	2 (AWG 14)	2 (AWG 14) (Note 1)	AWG 18 to 14 (Note 3)
MR-JE-20B/A	30 A frame 5 A (30 A frame 5 A)	S-N10 S-T10			
MR-JE-40B/A	30 A frame 10 A (30 A frame 5 A)	S-N10 S-T10			
MR-JE-70B/A	30 A frame 15 A (30 A frame 10 A)	S-N10 S-T10			
MR-JE-100B/A (3-phase power supply input)	30 A frame 15 A (30 A frame 10 A)	S-N10 S-T10			
MR-JE-100B/A (1-phase power supply input)	30A frame 15A (30A frame 15A)	S-N10 S-T10			
MR-JE-200B/A (3-phase power supply input)	30 A frame 20 A (30 A frame 20 A)	S-N20 (Note 5) S-T21	3.5 (AWG 12)		AWG 16 to 10 (Note 3)
MR-JE-200B/A (1-phase power supply input)	30A frame 20A (30A frame 20A)	S-N20 (Note 5) S-T21			
MR-JE-300B/A	30 A frame 30 A (30 A frame 30 A)	S-N20 S-T21			

- Notes: 1. Keep the wire length to the regenerative option within 5 m.  
2. Be sure to use a magnetic contactor with an operation delay time of 80 ms or less. The operation delay time is the time interval from current being applied to the coil until closure of contacts.  
3. The wire size shows applicable size for the servo amplifier connector.  
4. When complying with IEC/EN/UL/CSA standard, refer to "MELSERVO-JE Instructions and Cautions for Safe Use of AC Servos" enclosed with the servo amplifier. When using a power improving reactor, use a molded-case circuit breaker listed in the brackets.  
5. S-N18 can be used when auxiliary contact is not required.  
6. Install one molded-case circuit breaker and one magnetic contactor for each servo amplifier.

## Selection Example in HIV Wires for Servo Motors

The following are examples of wire sizes when 600 V grade heat-resistant polyvinyl chloride insulated wires (HIV wires) with a length of 30 m are used. Refer to "HG-KN HG-SN Servo Motor Instruction Manual" when using cab-tire cables for supplying power (U, V, and W) to HG-SN series.

Servo motor model	Wire size [mm <sup>2</sup> ]	
	For power and grounding (U, V, W, $\ominus$ ) (general environment)	For electromagnetic brake (B1, B2)
HG-KN13(B)J, 23(B)J, 43(B)J, 73(B)J	0.75 (AWG 18) (Note 1, 2, 3)	0.5 (AWG 20) (Note 4, 6)
HG-SN52(B)J, 102(B)J	1.25 (AWG 16) (Note 5)	1.25 (AWG 16)
HG-SN152(B)J, 202(B)J	2 (AWG 14)	
HG-SN302(B)J	3.5 (AWG 12)	

- Notes: 1. Use a fluorine resin wire of 0.75 mm<sup>2</sup> (AWG 18) for wiring to the servo motor power connector.  
2. This size is applicable for wiring length of 10 m or shorter. For over 10 m, use MR-PWS2CBL03M-A\_-L and extend it with HIV wire of 1.25 mm<sup>2</sup> (AWG 16).  
3. When complying with UL/CSA standard, extend the wire using MR-PWS2CBL03M-A\_-L and HIV wire of 2 mm<sup>2</sup> (AWG 14).  
4. Use a fluorine resin wire of 0.5 mm<sup>2</sup> (AWG 20) when connecting to servo motor electromagnetic brake connector.  
5. When complying with UL/CSA standard, use 2 mm<sup>2</sup> (AWG 14). Refer to "HG-KN HG-SN Servo Motor Instruction Manual" for details.  
6. This size is applicable for wiring length of 10 m or shorter. For over 10 m, extend the wire with HIV wire of 1.25 mm<sup>2</sup> (AWG 16).

Servo Amplifiers

Servo Motors

Options/Peripheral Equipment

LVSM/Wires

Product List

Cautions

## Servo amplifiers

Item	Model	Rated output	Power supply
MR-JE-B	MR-JE-10B	0.1 kW	3-phase or 1-phase 200 V AC to 240 V AC
	MR-JE-20B	0.2 kW	3-phase or 1-phase 200 V AC to 240 V AC
	MR-JE-40B	0.4 kW	3-phase or 1-phase 200 V AC to 240 V AC
	MR-JE-70B	0.75 kW	3-phase or 1-phase 200 V AC to 240 V AC
	MR-JE-100B	1 kW	3-phase or 1-phase 200 V AC to 240 V AC
	MR-JE-200B	2 kW	3-phase or 1-phase 200 V AC to 240 V AC
MR-JE-A	MR-JE-300B	3 kW	3-phase 200 V AC to 240 V AC
	MR-JE-10A	0.1 kW	3-phase or 1-phase 200 V AC to 240 V AC
	MR-JE-20A	0.2 kW	3-phase or 1-phase 200 V AC to 240 V AC
	MR-JE-40A	0.4 kW	3-phase or 1-phase 200 V AC to 240 V AC
	MR-JE-70A	0.75 kW	3-phase or 1-phase 200 V AC to 240 V AC
	MR-JE-100A	1 kW	3-phase or 1-phase 200 V AC to 240 V AC
	MR-JE-200A	2 kW	3-phase or 1-phase 200 V AC to 240 V AC
	MR-JE-300A	3 kW	3-phase 200 V AC to 240 V AC

## Servo motors

Item	Model	Rated output	Rated speed
HG-KN series Without electromagnetic brake With oil seal	HG-KN13J	100 W	3000 r/min
	HG-KN23J	200 W	3000 r/min
	HG-KN43J	400 W	3000 r/min
	HG-KN73J	750 W	3000 r/min
HG-KN series Without electromagnetic brake Without oil seal	HG-KN13	100 W	3000 r/min
	HG-KN23	200 W	3000 r/min
	HG-KN43	400 W	3000 r/min
HG-KN series With electromagnetic brake With oil seal	HG-KN13BJ	100 W	3000 r/min
	HG-KN23BJ	200 W	3000 r/min
	HG-KN43BJ	400 W	3000 r/min
HG-KN series With electromagnetic brake Without oil seal	HG-KN73BJ	750 W	3000 r/min
	HG-KN13B	100 W	3000 r/min
	HG-KN23B	200 W	3000 r/min
HG-SN series Without electromagnetic brake With oil seal	HG-KN43B	400 W	3000 r/min
	HG-SN52J	0.5 kW	2000 r/min
	HG-SN102J	1.0 kW	2000 r/min
	HG-SN152J	1.5 kW	2000 r/min
	HG-SN202J	2.0 kW	2000 r/min
HG-SN series With electromagnetic brake With oil seal	HG-SN302J	3.0 kW	2000 r/min
	HG-SN52BJ	0.5 kW	2000 r/min
	HG-SN102BJ	1.0 kW	2000 r/min
	HG-SN152BJ	1.5 kW	2000 r/min
	HG-SN202BJ	2.0 kW	2000 r/min
	HG-SN302BJ	3.0 kW	2000 r/min

## Encoder cables/Junction cables

Item	Model	Length	Bending life	IP rating	Application
Encoder cable (load-side lead)	MR-J3ENCBL2M-A1-H	2 m	Long bending life	IP65	For HG-KN (direct connection type)
	MR-J3ENCBL5M-A1-H	5 m	Long bending life	IP65	For HG-KN (direct connection type)
	MR-J3ENCBL10M-A1-H	10 m	Long bending life	IP65	For HG-KN (direct connection type)
	MR-J3ENCBL2M-A1-L	2 m	Standard	IP65	For HG-KN (direct connection type)
	MR-J3ENCBL5M-A1-L	5 m	Standard	IP65	For HG-KN (direct connection type)
	MR-J3ENCBL10M-A1-L	10 m	Standard	IP65	For HG-KN (direct connection type)
Encoder cable (opposite to load-side lead)	MR-J3ENCBL2M-A2-H	2 m	Long bending life	IP65	For HG-KN (direct connection type)
	MR-J3ENCBL5M-A2-H	5 m	Long bending life	IP65	For HG-KN (direct connection type)
	MR-J3ENCBL10M-A2-H	10 m	Long bending life	IP65	For HG-KN (direct connection type)
	MR-J3ENCBL2M-A2-L	2 m	Standard	IP65	For HG-KN (direct connection type)
	MR-J3ENCBL5M-A2-L	5 m	Standard	IP65	For HG-KN (direct connection type)
	MR-J3ENCBL10M-A2-L	10 m	Standard	IP65	For HG-KN (direct connection type)
Encoder cable (load-side lead)	MR-J3JCBL03M-A1-L	0.3 m	Standard	IP20	For HG-KN (junction type) <sup>(Note 1)</sup>
Encoder cable (opposite to load-side lead)	MR-J3JCBL03M-A2-L	0.3 m	Standard	IP20	For HG-KN (junction type) <sup>(Note 1)</sup>
Encoder cable	MR-EKCBL20M-H	20 m	Long bending life	IP20	For HG-KN (junction type) <sup>(Note 2)</sup>
	MR-EKCBL30M-H	30 m	Long bending life	IP20	For HG-KN (junction type) <sup>(Note 2)</sup>
	MR-EKCBL40M-H	40 m	Long bending life	IP20	For HG-KN (junction type) <sup>(Note 2)</sup>
	MR-EKCBL50M-H	50 m	Long bending life	IP20	For HG-KN (junction type) <sup>(Note 2)</sup>
	MR-EKCBL20M-L	20 m	Standard	IP20	For HG-KN (junction type) <sup>(Note 2)</sup>
	MR-EKCBL30M-L	30 m	Standard	IP20	For HG-KN (junction type) <sup>(Note 2)</sup>
Encoder cable (load-side lead)	MR-J3JSCBL03M-A1-L	0.3 m	Standard	IP65	For HG-KN (junction type) <sup>(Note 3)</sup>
Encoder cable (opposite to load-side lead)	MR-J3JSCBL03M-A2-L	0.3 m	Standard	IP65	For HG-KN (junction type) <sup>(Note 3)</sup>
Encoder cable	MR-J3ENCBL2M-H	2 m	Long bending life	IP67	For HG-KN (junction type) <sup>(Note 4)</sup> , For HG-SN (direct connection type)
	MR-J3ENCBL5M-H	5 m	Long bending life	IP67	
	MR-J3ENCBL10M-H	10 m	Long bending life	IP67	
	MR-J3ENCBL20M-H	20 m	Long bending life	IP67	
	MR-J3ENCBL30M-H	30 m	Long bending life	IP67	
	MR-J3ENCBL40M-H	40 m	Long bending life	IP67	
	MR-J3ENCBL50M-H	50 m	Long bending life	IP67	
	MR-J3ENCBL2M-L	2 m	Standard	IP67	For HG-KN (junction type) <sup>(Note 4)</sup> , For HG-SN (direct connection type)
	MR-J3ENCBL5M-L	5 m	Standard	IP67	
	MR-J3ENCBL10M-L	10 m	Standard	IP67	
	MR-J3ENCBL20M-L	20 m	Standard	IP67	
	MR-J3ENCBL30M-L	30 m	Standard	IP67	
MR-J3ENCBL40M-L	40 m	Standard	IP67		

### Notes:

1. Use this in combination with MR-EKCBL\_M-H, MR-EKCBL\_M-L, or MR-ECNM.
2. Use this in combination with MR-J3JCBL03M-A1-L or MR-J3JCBL03M-A2-L.
3. Use this in combination with MR-J3ENCBL\_M-H, MR-J3ENCBL\_M-L, or MR-J3SCNS.
4. Use this in combination with MR-J3JSCBL03M-A1-L or MR-J3JSCBL03M-A2-L when using for HG-KN series.

## Encoder connector sets/Junction connector sets

Item	Model	Description	IP rating	Application
Encoder connector set	MR-ECNM	Junction connector × 1 Servo amplifier connector × 1	IP20	For HG-KN (junction type) <sup>(Note 1)</sup>
Encoder connector set (one-touch connection type)	MR-J3SCNS	Straight type Junction connector or encoder connector × 1 Servo amplifier connector × 1	IP67	For HG-KN (junction type) <sup>(Note 2)</sup> , For HG-SN (direct connection type)
Encoder connector set (screw type)	MR-ENCNS2	Straight type Encoder connector × 1 Servo amplifier connector × 1	IP67	For HG-SN
Encoder connector set (one-touch connection type)	MR-J3SCNSA	Angle type Encoder connector × 1 Servo amplifier connector × 1	IP67	For HG-SN
Encoder connector set (screw type)	MR-ENCNS2A	Angle type Encoder connector × 1 Servo amplifier connector × 1	IP67	For HG-SN

## Servo motor power cables

Item	Model	Length	Bending life	IP rating	Application
Servo motor power cable (load-side, lead-out)	MR-PWS1CBL2M-A1-H	2 m	Long bending life	IP65	For HG-KN (direct connection type)
	MR-PWS1CBL5M-A1-H	5 m	Long bending life	IP65	For HG-KN (direct connection type)
	MR-PWS1CBL10M-A1-H	10 m	Long bending life	IP65	For HG-KN (direct connection type)
	MR-PWS1CBL2M-A1-L	2 m	Standard	IP65	For HG-KN (direct connection type)
	MR-PWS1CBL5M-A1-L	5 m	Standard	IP65	For HG-KN (direct connection type)
	MR-PWS1CBL10M-A1-L	10 m	Standard	IP65	For HG-KN (direct connection type)
Servo motor power cable (opposite to load-side lead, lead-out)	MR-PWS1CBL2M-A2-H	2 m	Long bending life	IP65	For HG-KN (direct connection type)
	MR-PWS1CBL5M-A2-H	5 m	Long bending life	IP65	For HG-KN (direct connection type)
	MR-PWS1CBL10M-A2-H	10 m	Long bending life	IP65	For HG-KN (direct connection type)
	MR-PWS1CBL2M-A2-L	2 m	Standard	IP65	For HG-KN (direct connection type)
	MR-PWS1CBL5M-A2-L	5 m	Standard	IP65	For HG-KN (direct connection type)
	MR-PWS1CBL10M-A2-L	10 m	Standard	IP65	For HG-KN (direct connection type)
Servo motor power cable (load-side lead, lead-out)	MR-PWS2CBL03M-A1-L	0.3 m	Standard	IP55	For HG-KN (junction type)
Servo motor power cable (opposite to load-side lead, lead-out)	MR-PWS2CBL03M-A2-L	0.3 m	Standard	IP55	For HG-KN (junction type)

## Servo motor power connector sets

Item	Model	Description	IP rating	Application
Servo motor power connector set EN compliant	MR-PWCNS4	Straight type Power connector × 1	IP67	For HG-SN52J, 102J, 152J
	MR-PWCNS5	Straight type Power connector × 1	IP67	For HG-SN202J, 302J

### Notes:

1. Use this in combination with MR-J3JCBL03M-A1-L or MR-J3JCBL03M-A2-L.
2. Use this in combination with MR-J3JSCBL03M-A1-L or MR-J3JSCBL03M-A2-L when using for HG-KN series.

### Electromagnetic brake cables

Item	Model	Length	Bending life	IP rating	Application
Electromagnetic brake cable (load-side lead, lead-out)	MR-BKS1CBL2M-A1-H	2 m	Long bending life	IP65	For HG-KN (direct connection type)
	MR-BKS1CBL5M-A1-H	5 m	Long bending life	IP65	For HG-KN (direct connection type)
	MR-BKS1CBL10M-A1-H	10 m	Long bending life	IP65	For HG-KN (direct connection type)
	MR-BKS1CBL2M-A1-L	2 m	Standard	IP65	For HG-KN (direct connection type)
	MR-BKS1CBL5M-A1-L	5 m	Standard	IP65	For HG-KN (direct connection type)
	MR-BKS1CBL10M-A1-L	10 m	Standard	IP65	For HG-KN (direct connection type)
Electromagnetic brake cable (opposite to load-side lead, lead-out)	MR-BKS1CBL2M-A2-H	2 m	Long bending life	IP65	For HG-KN (direct connection type)
	MR-BKS1CBL5M-A2-H	5 m	Long bending life	IP65	For HG-KN (direct connection type)
	MR-BKS1CBL10M-A2-H	10 m	Long bending life	IP65	For HG-KN (direct connection type)
	MR-BKS1CBL2M-A2-L	2 m	Standard	IP65	For HG-KN (direct connection type)
	MR-BKS1CBL5M-A2-L	5 m	Standard	IP65	For HG-KN (direct connection type)
	MR-BKS1CBL10M-A2-L	10 m	Standard	IP65	For HG-KN (direct connection type)
Electromagnetic brake cable (load-side lead, lead-out)	MR-BKS2CBL03M-A1-L	0.3 m	Standard	IP55	For HG-KN (junction type)
Electromagnetic brake cable (opposite to load-side lead, lead-out)	MR-BKS2CBL03M-A2-L	0.3 m	Standard	IP55	For HG-KN (junction type)

### Electromagnetic brake connector sets

Item	Model	Description	IP rating	Application
Electromagnetic brake connector set (one-touch connection type)	MR-BKCNS1	Straight type Electromagnetic brake connector × 1	IP67	For HG-SN
Electromagnetic brake connector set (screw type)	MR-BKCNS2	Straight type Electromagnetic brake connector × 1	IP67	For HG-SN
Electromagnetic brake connector set (one-touch connection type)	MR-BKCNS1A	Angle type Electromagnetic brake connector × 1	IP67	For HG-SN
Electromagnetic brake connector set (screw type)	MR-BKCNS2A	Angle type Electromagnetic brake connector × 1	IP67	For HG-SN

### SSCNET III cables/SSCNET III connector set

Item	Model	Length	Bending life	IP rating	Application
SSCNET III cable (standard cord inside cabinet) Compatible with SSCNET III(/H)	MR-J3BUS015M	0.15 m	Standard	-	For MR-JE-B
	MR-J3BUS03M	0.3 m	Standard	-	For MR-JE-B
	MR-J3BUS05M	0.5 m	Standard	-	For MR-JE-B
	MR-J3BUS1M	1 m	Standard	-	For MR-JE-B
	MR-J3BUS3M	3 m	Standard	-	For MR-JE-B
SSCNET III cable (standard cord outside cabinet) Compatible with SSCNET III(/H)	MR-J3BUS5M-A	5 m	Standard	-	For MR-JE-B
	MR-J3BUS10M-A	10 m	Standard	-	For MR-JE-B
	MR-J3BUS20M-A	20 m	Standard	-	For MR-JE-B
SSCNET III cable (long distance cable) Compatible with SSCNET III(/H)	MR-J3BUS30M-B	30 m	Long bending life	-	For MR-JE-B
	MR-J3BUS40M-B	40 m	Long bending life	-	For MR-JE-B
	MR-J3BUS50M-B	50 m	Long bending life	-	For MR-JE-B
SSCNET III connector set Compatible with SSCNET III(/H)	MR-J3BCN1	-	-	-	For MR-JE-B

### Junction terminal blocks/Junction terminal block cables

Item	Model	Length	Application
Junction terminal block (50 pins)	MR-TB50	-	For MR-JE-A
Junction terminal block cable (for MR-TB50)	MR-J2M-CN1TBL05M	0.5 m	For connecting MR-JE-A and MR-TB50
	MR-J2M-CN1TBL1M	1 m	For connecting MR-JE-A and MR-TB50

## Batteries/Battery case/Battery cables

Item	Model	Length	Application
Battery	MR-BAT6V1SET-A	-	For MR-JE-B
	MR-BAT6V1	-	For MR-BAT6V1SET-A and MR-BT6VCASE
Battery case	MR-BT6VCASE	-	For MR-JE-B
Battery cable	MR-BT6V1CBL03M	0.3 m	For MR-BT6VCASE
	MR-BT6V1CBL1M	1 m	For MR-BT6VCASE
Junction battery cable	MR-BT6V2CBL03M	0.3 m	For MR-BT6VCASE
	MR-BT6V2CBL1M	1 m	For MR-BT6VCASE

## Regenerative options

Item	Model	Specifications	Application
Regenerative option	MR-RB032	Tolerable regenerative power: 30 W, resistance value: 40 Ω	For MR-JE-10B to MR-JE-100B and MR-JE-10A to MR-JE-100A
	MR-RB12	Tolerable regenerative power: 100 W, resistance value: 40 Ω	For MR-JE-20B to MR-JE-100B and MR-JE-20A to MR-JE-100A
	MR-RB30	Tolerable regenerative power: 300 W, resistance value: 13 Ω	For MR-JE-200B/MR-JE-300B and MR-JE-200A/MR-JE-300A
	MR-RB32	Tolerable regenerative power: 300 W, resistance value: 40 Ω	For MR-JE-70B/MR-JE-100B and MR-JE-70A/MR-JE-100A
	MR-RB50	Tolerable regenerative power: 500 W, resistance value: 13 Ω	For MR-JE-200B/MR-JE-300B and MR-JE-200A/MR-JE-300A

## Peripheral cable

Item	Model	Length	Application
Personal computer communication cable (USB cable)	MR-J3USBCBL3M	3 m	For MR-JE-B and MR-JE-A

## Peripheral connectors

Item	Model	Description	Application
Servo amplifier CNP1 power connector <sup>(Note 1)</sup> (insertion type)	MR-JECNP1-01	CNP1 connector × 1, Open tool × 1	For MR-JE-10B to MR-JE-100B and MR-JE-10A to MR-JE-100A
Servo amplifier CNP1 power connector <sup>(Note 1)</sup> (insertion type)	MR-JECNP1-02	CNP1 connector × 1, Open tool × 1	For MR-JE-200B/MR-JE-300B and MR-JE-200A/MR-JE-300A
Servo amplifier CNP2 power connector <sup>(Note 1)</sup> (insertion type)	MR-JECNP2-02	CNP2 connector × 1	For MR-JE-200B/MR-JE-300B and MR-JE-200A/MR-JE-300A
Connector set	MR-CCN1	Servo amplifier connectotr × 1	For IO signals of MR-JE-B
Connector set	MR-J3CN1	Servo amplifier connector × 1	For IO signals of MR-JE-A

## Servo Support Software

Item	Model	Application
MR Configurator2	SW1DNC-MRC2-E	Servo setup software for AC servo

Note:

1. CNP1 and CNP2 connectors, and open tool are supplied with the servo amplifier.

**MEMO**

Servo Amplifiers

Servo Motors

Options/Peripheral  
Equipment

LVS/Wires

**Product List**

Cautions

## To ensure safe use

- To use the products given in this catalog properly, always read the "Installation Guide" and "Instruction Manual" before starting to use them.

## Cautions for model selection

- Select a servo motor which has the rated torque equal to or higher than the continuous effective torque.
- When unbalanced torque is generated, such as in a vertical lift machine, keep the unbalanced torque of the machine under 70% of the servo motor rated torque.
- Create the operating pattern by considering the settling time ( $t_s$ ).
- Load to motor inertia ratio must be below the recommended ratio. If the ratio is too large, the expected performance may not be achieved, and the dynamic brake may be damaged.

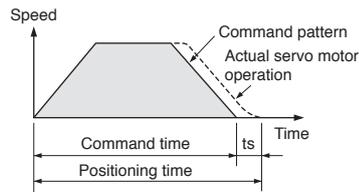

## General safety precautions

### 1. Transportation/installation

- Combinations of the servo motor and the servo amplifier are predetermined. Confirm the models of the servo motor and the servo amplifier to be used before installation.
- Do not drop or apply strong impact on the servo amplifier and the servo motor as they are precision devices. They may be damaged from such stress or shock.
- When fumigants that contain halogen materials such as fluorine, chlorine, bromine, and iodine are used for disinfecting and protecting wooden packaging from insects, they cause malfunction when entering our products. Please take necessary precautions to ensure that remaining materials from fumigant do not enter our products, or treat packaging with methods other than fumigation (heat method). Additionally, disinfect and protect wood from insects before packing products.
- Do not get on or place heavy objects on the servo amplifier or the servo motor. Doing so may result in injury or damage.
- The system must withstand high speeds and high acceleration/deceleration.
- To enable high-accuracy positioning, ensure the machine rigidity, and keep the machine resonance point at a high level.
- Mount the servo amplifier and the servo motor on nonflammable material. Mounting them directly on or near flammable material may result in fires.
- The regenerative option becomes hot (the temperature rise of 100 °C or higher) with frequent use. Do not install within flammable objects or objects subject to thermal deformation. Make sure that wires do not come into contact with the unit.
- Securely fix the servo motor onto the machine. Insufficient fixing may cause the servo motor to dislocate during operation.
- Install electrical and mechanical stoppers at the stroke end.
- Mount the servo amplifier vertically on a wall.
- Do not block intake and exhaust areas of the servo amplifier. Doing so may cause the servo amplifier to malfunction.
- When installing multiple servo amplifiers in a row in a sealed cabinet, leave space around the servo amplifiers as described in Servo Amplifier Instruction Manual. To ensure the life and reliability of the servo amplifiers, prevent heat accumulation by keeping space as open as possible toward the top plate.

### 2. Environment

- Use the servo amplifier and the servo motor in the designated environment.

- Avoid installing the servo amplifier and the servo motor in areas with oil mist or dust. When installing in such areas, be sure to enclose the servo amplifier in a sealed cabinet, and protect the servo motor by furnishing a cover or by taking similar measures.
- Do not use in areas where the servo motor may be constantly subject to cutting fluid or lubricant oil, or where dew could condense because of oil mist, overcooling or excessive humidity. Doing so may deteriorate the insulation of the servo motor.

### 3. Grounding

- Securely ground to prevent electric shocks and to stabilize the potential in the control circuit.
- Connect the grounding wire to the cabinet protective earth (PE) terminal via the servo amplifier protective earth (PE) terminal for the servo motor grounding.
- Faults such as a position mismatch may occur if the grounding is insufficient.

### 4. Wiring

- Do not supply power to the output terminals (U, V, and W) of the servo amplifier or the input terminals (U, V, and W) of the servo motor. Doing so damages the servo amplifier and the servo motor.
- Connect the servo motor to the output terminals (U, V, and W) of the servo amplifier.
- Match the phase of the input terminals (U, V, and W) of the servo motor to the output terminals (U, V, and W) of the servo amplifier when connecting them. If they do not match, the servo motor does not operate properly.
- Check the wiring and sequence program thoroughly before switching the power on.
- Carefully select the cable clamping method, and make sure that bending stress and the stress of the cable's own weight are not applied on the cable connection section.
- In an application where the servo motor moves, determine the cable bending radius according to the cable bending life and wire type.

### 5. Initial settings

- For MR-JE-A, select a control mode from position, speed or torque by [Pr. PA01]. Position control mode is set as default. Change the parameter setting value when using the other control modes. For MR-JE-B, the control mode is set by the controller.
- When using the regenerative option, change [Pr. PA02]. The regenerative option is disabled as default.

### 6. Operation

- Do not use a product which is damaged or has missing parts. In that case, replace the product.
- Turn on FLS and RLS (Upper/Lower stroke limit), or LSP and LSN (Forward/Reverse rotation stroke end) in position or speed control mode. The servo motor will not start if the signals are off.
- When a magnetic contactor is installed on the primary side of the servo amplifier, do not perform frequent starts and stops with the magnetic contactor. Doing so may damage the servo amplifier.
- When an error occurs, the servo amplifier stops outputting the power with activation of the protective function, and the servo motor stops immediately with the dynamic brake.
- The dynamic brake is a function for emergency stop. Do not use it to stop the servo motor in normal operations.
- As a rough guide, the dynamic brake withstands 1000 times of use when a machine which has load to motor inertia ratio equals to or lower than the recommended ratio stops from the rated speed every 10 minutes.
- If the protective functions of the servo amplifier activate, turn the power off immediately. Remove the cause before turning the power on again. If operation is continued without removing the cause of the error, the servo motor may malfunction, resulting in injury or damage.



- The servo amplifier, the regenerative resistor, and the servo motor can be very hot during or after operation. Take safety measures such as covering them to prevent your hand and/or parts including cables from coming in contact with them.

#### 7. Others

- Do not touch the servo amplifier or the servo motor with wet hands.
- Do not modify the servo amplifier or the servo motor.

#### Cautions for SSCNET III cables

- Do not apply excessive tension on the SSCNET III cable when cabling.
- The minimum bending radius of the SSCNET III cable is 25 mm for MR-J3BUS\_M and 50 mm for MR-J3BUS\_M-A/-B. If using these cables under the minimum bending radius, performance cannot be guaranteed.
- If the ends of the SSCNET III cable are dirty, the light will be obstructed, causing malfunctions. Keep the ends clean.
- Do not tighten the SSCNET III cable with cable ties, etc.
- Do not look at the light directly when the SSCNET III cable is not connected.

#### Cautions for servo motors

- Do not hammer the shaft of the servo motor when installing a pulley or a coupling. Doing so may damage the encoder. When installing the pulley or the coupling to the key shaft servo motor, use the screw hole on the shaft end. Use a pulley extractor when removing the pulley.
- Do not apply a load exceeding the tolerable load onto the servo motor shaft. The shaft may break.
- When the servo motor is mounted with the shaft vertical (shaft up), take measures on the machine side so that oil from the gear box does not get into the servo motor.
- Do not use the 24 V DC interface power supply for the electromagnetic brake. Provide a dedicated power supply to the electromagnetic brake.
- Do not apply the electromagnetic brake when the servo is on. Doing so may cause the servo amplifier overload or shorten the brake life. Apply the electromagnetic brake when the servo is off.
- Torque may drop due to temperature increase of the servo motor. Be sure to use the motor within the specified ambient temperature.

## Warranty

### 1. Warranty period and coverage

We will repair any failure or defect hereinafter referred to as "failure" in our FA equipment hereinafter referred to as the "Product" arisen during warranty period at no charge due to causes for which we are responsible through the distributor from which you purchased the Product or our service provider. However, we will charge the actual cost of dispatching our engineer for an on-site repair work on request by customer in Japan or overseas countries. We are not responsible for any on-site readjustment and/or trial run that may be required after a defective unit is repaired or replaced.

#### [Term]

The term of warranty for Product is twelve (12) months after your purchase or delivery of the Product to a place designated by you or eighteen (18) months from the date of manufacture whichever comes first ("Warranty Period"). Warranty period for repaired Product cannot exceed beyond the original warranty period before any repair work.

#### [Limitations]

- (1) You are requested to conduct an initial failure diagnosis by yourself, as a general rule. It can also be carried out by us or our service company upon your request and the actual cost will be charged. However, it will not be charged if we are responsible for the cause of the failure.
- (2) This limited warranty applies only when the condition, method, environment, etc. of use are in compliance with the terms and conditions and instructions that are set forth in the instruction manual and user manual for the Product and the caution label affixed to the Product.
- (3) Even during the term of warranty, the repair cost will be charged on you in the following cases;
  - (i) a failure caused by your improper storing or handling, carelessness or negligence, etc., and a failure caused by your hardware or software problem
  - (ii) a failure caused by any alteration, etc. to the Product made on your side without our approval
  - (iii) a failure which may be regarded as avoidable, if your equipment in which the Product is incorporated is equipped with a safety device required by applicable laws and has any function or structure considered to be indispensable according to a common sense in the industry
  - (iv) a failure which may be regarded as avoidable if consumable parts designated in the instruction manual, etc. are duly maintained and replaced
  - (v) any replacement of consumable parts (battery, fan, smoothing capacitor, etc.)
  - (vi) a failure caused by external factors such as inevitable accidents, including without limitation fire and abnormal fluctuation of voltage, and acts of God, including without limitation earthquake, lightning and natural disasters
  - (vii) a failure generated by an unforeseeable cause with a scientific technology that was not available at the time of the shipment of the Product from our company
  - (viii) any other failures which we are not responsible for or which you acknowledge we are not responsible for

### 2. Term of warranty after the stop of production

- (1) We may accept the repair at charge for another seven (7) years after the production of the product is discontinued. The announcement of the stop of production for each model can be seen in our Sales and Service, etc.
- (2) Please note that the Product (including its spare parts) cannot be ordered after its stop of production.

### 3. Service in overseas countries

Our regional FA Center in overseas countries will accept the repair work of the Product. However, the terms and conditions of the repair work may differ depending on each FA Center. Please ask your local FA Center for details.

### 4. Exclusion of responsibility for compensation against loss of opportunity, secondary loss, etc.

Whether under or after the term of warranty, we assume no responsibility for any damages arisen from causes for which we are not responsible, any losses of opportunity and/or profit incurred by you due to a failure of the Product, any damages, secondary damages or compensation for accidents arisen under a specific circumstance that are foreseen or unforeseen by our company, any damages to products other than the Product, and also compensation for any replacement work, readjustment, start-up test run of local machines and the Product and any other operations conducted by you.

### 5. Change of Product specifications

Specifications listed in our catalogs, manuals or technical documents may be changed without notice.

### 6. Application and use of the Product

- (1) For the use of our General-Purpose AC Servo, its applications should be those that may not result in a serious damage even if any failure or malfunction occurs in General-Purpose AC Servo, and a backup or fail-safe function should operate on an external system to General-Purpose AC Servo when any failure or malfunction occurs.
- (2) Our General-Purpose AC Servo is designed and manufactured as a general purpose product for use at general industries. Therefore, applications substantially influential on the public interest for such as atomic power plants and other power plants of electric power companies, and also which require a special quality assurance system, including applications for railway companies and government or public offices are not recommended, and we assume no responsibility for any failure caused by these applications when used.

In addition, applications which may be substantially influential to human lives or properties for such as airlines, medical treatments, railway service, incineration and fuel systems, man-operated material handling equipment, entertainment machines, safety machines, etc. are not recommended, and we assume no responsibility for any failure caused by these applications when used.

We will review the acceptability of the abovementioned applications, if you agree not to require a specific quality for a specific application. Please contact us for consultation.

**MEMO**

Servo Amplifiers

Servo Motors

Options/Peripheral  
Equipment

LVS/Wires

Product List

**Cautions**

MEMO

**MEMO**

Servo Amplifiers

Servo Motors

Options/Peripheral  
Equipment

LVS/Wires

Product List

Cautions

# FA Products

PLC

MELSEC-Q Series Universal Model



Introducing the high-speed QCPU (QnUDVCP) for faster processing of large data volumes.

- ◎Realize high-speed, high-accuracy machine control with various iQ Platform compatible controllers and multiple CPUs.
- ◎Easily connect to GOTs and Programming tools using built-in Ethernet port.
- ◎25 models from 10K steps small capacity to 1000K steps large capacity, are available.
- ◎Seamless communication and flexible integration at any network level.

Product Specifications

Program capacity	10K steps to 1000K steps
Number of I/O points [X/Y], number of I/O device points [X/Y]	256 points to 4096 points/8192 points
Basic instruction processing speed (LD instruction)	120 ns to 1.9 ns
External connection interface	USB (all models equipped), Ethernet, RS-232, memory card, extended SRAM cassette
Function module	I/O, analog, high-speed counter, positioning, simple motion, temperature input, temperature control, network module
Module extension style	Building block type
Network	Ethernet, CC-Link IE controller network, CC-Link IE field network, CC-Link, CC-Link/LT, MELSECNET/H, SSCNETIII (/H), AnyWire, RS-232, RS-422

PLC

MELSEC-L Series



“Light & Flexible” condensing various functions easily and flexibly.

- ◎CPU equipped as a standard with various functions including counter, positioning and CC-Link.
- ◎The base-less structure with high degree of freedom saves space in the control panel.
- ◎Easily confirm the system status and change the settings with the display unit.
- ◎Ten models are available in program capacities from 20 k steps to 260 k steps.

Product specifications

Program capacity	20 k steps/60 k steps/260 k steps
Number of input/output points [X/Y]	1024 points/4096 points
Number of input/output device points [X/Y]	8192 points
Basic instruction processing speed (LD instruction)	60 ns/ 40 ns/ 9.5 ns
External connection interface	USB, Ethernet, RS-232, SD memory card, CC-Link (L26CPU-BT/PBT)
Function modules	I/O, analog, high-speed counter, positioning, simple motion, temperature control, network module
Unit expansion style	Base-less structure
Network	Ethernet, CC-Link IE Field network, CC-Link, CC-Link/LT, SSCNETIII(/H), RS-232, RS-422

Programmable Controller

MELSEC-F Series



All-in-One Micro Programmable Controller equipped with all necessary functions in a compact body

- ◎Supporting small-scale control from 10 points to 384 points (using CC-Link) with an outstanding cost performance.
- ◎Wide range of options available for additional functions required by your system.
- ◎Easy to use and highly reliable. More than 12 million units have shipped worldwide. (April 2013)
- ◎Small-scale control is available in various networks such as CC-Link, Ethernet, and MODBUS.

Product specifications

Program capacity	16k steps (FX <sub>3S</sub> ) to 64 k steps (FX <sub>3U</sub> /FX <sub>3UC</sub> )
Number of input/output points	10 points (FX <sub>3S</sub> ) to 384 points (FX <sub>3U</sub> /FX <sub>3UC</sub> with CC-Link)
Basic instruction processing speed	0.21 μs (FX <sub>3S</sub> ) to 65 ns (FX <sub>3U</sub> /FX <sub>3UC</sub> )
External connection interface	RS-422, USB (FX <sub>3S</sub> /FX <sub>3U</sub> /FX <sub>3UC</sub> /FX <sub>3GE</sub> only), Ethernet (FX <sub>3GE</sub> only), CC-Link/LT (FX <sub>3UC</sub> -32MT-LT(-2) only)
Built-in functions	I/O, high-speed counter input, positioning pulse output, analog (FX <sub>3GE</sub> only)
Extended functions	I/O, analog, temperature control, high-speed counter, positioning, network
Unit expansion style	Backplane-less design
Network	Ethernet, CC-Link, CC-Link/LT, SSCNETIII, CANopen, J1939, RS-232C, RS-422, RS-485, MODBUS

HMI

Graphic Operation Terminal GOT2000 Series GT27 Model



To the top of HMIs with further user-friendly, satisfactory standard features.

- ◎ Comfortable screen operation even if high-load processing (e.g. logging, device data transfer) is running. (Monitoring performance is twice faster than GT16)
- ◎ Actual usable space without using a SD card is expanded to 128MB for more flexible screen design.
- ◎ Multi-touch features, two-point press, and scroll operations for more user-friendliness.
- ◎ Outline font and PNG images for clear, beautiful screen display.

Product Specifications

Screen size	15", 12.1", 10.4", 8.4"
Resolution	XGA, SVGA, VGA
Intensity adjustment	32-step adjustment
Touch panel type	Analog resistive film
Built-in interface	RS-232, RS-422/485, Ethernet, USB, SD card
Applicable software	GT Works3
Input power supply voltage	100 to 240VAC (+10%, -15%), 24VDC (+25%, -20%)

AC Servo

Mitsubishi General-Purpose AC Servo MELSERVO-J4 Series



Industry-leading level of high performance servo

- ◎ Industry-leading level of basic performance: Speed frequency response (2.5kHz), 4,000,000 (4,194,304p/rev) encoder
- ◎ Advanced one-touch tuning function achieves the one-touch adjustment of advanced vibration suppression control II, etc.
- ◎ Equipped with large capacity drive recorder and machine diagnosis function for easy maintenance.
- ◎ 2-axis and 3-axis servo amplifiers are available for energy-conservative, space-saving, and low-cost machines.

Product Specifications

Power supply specifications	1-phase/3-phase 200V AC, 1-phase 100V AC, 3-phase 400V AC
Command interface	SSCNET III/H, SSCNET III (compatible in J3 compatibility mode), CC-Link IE Field Network interface with Motion, pulse train, analog
Control mode	Position/Speed/Torque/Positioning function/Fully closed loop
Speed frequency response	2.5kHz
Tuning function	Advanced one-touch tuning, advanced vibration suppression control II, robust filter, etc.
Functional safety	Conforms to functions of IEC/EN 61800-5-2, STO: Category 3 PL d, SIL 2 Conforms to Category 4 PL e, SIL 3 by a combination with MR-D30 functional safety unit
Compatible servo motor	Rotary servo motor (rated output: 0.05 to 55kW), linear servo motor (continuous thrust 50 to 3000N), direct drive motor (rated torque: 2 to 240N·m)

Inverter

FR-A800 Series



High-functionality, high-performance inverter

- ◎ Realize even higher responsiveness during real sensor-less vector control or vector control, and achieve faster operating frequencies.
- ◎ The latest automatic tuning function supports various induction motors and also sensor-less PM motors.
- ◎ The standard model is compatible with EU Safety Standards STO (PLd, SIL2). Add options to support higher level safety standards.
- ◎ Control and monitor inverters via CC-Link/CC-Link IE Field Network (option interface).

Product Specifications

Inverter capacity	200V class: 0.4kW to 90kW, 400V class: 0.4kW to 500kW
Control method	High-carrier frequency PWM control (Select from V/F, advanced magnetic flux vector, real sensorless vector or PM sensorless vector control), vector control (when using options)
Output frequency range	0.2 to 590Hz (upper limit is 400Hz when using advanced magnetic flux vector control, real sensorless vector control, vector control or PM sensorless vector control)
Regenerative braking torque (Maximum allowable duty)	200V class: 0.4K to 1.5K (150% at 3%ED) 2.2K/3.7K (100% at 3%ED) 5.5K/7.5K (100% at 2%ED) 11K to 55K (20% continuous) 75K or more (10% continuous), 400V class: 0.4K to 7.5K (100% at 2%ED) 11K to 55K (20% continuous) 75K or more (10% continuous)
Starting torque	200% 0.3Hz (3.7K or less), 150% 0.3Hz (5.5K or more) (when using real sensorless vector, vector control)



# FA Products

Three-Phase Motor

High Performance Energy-Saving Motor

Super Line Premium Series

SF-PR



Premium Efficiency & Compatible. New Launch of Super Line Premium Series SF-PR Model

- ◎Compared to general efficiency motor SF-JR model, generated loss is reduced by 37% on average, and it is compatible with highly efficient premium IE3.
- ◎Easy replacement is achieved as mounting dimension (frame number) is compatible with general efficiency motor SF-JR model.
- ◎One motor can accommodate different power sources of Japan and the U.S. Three ratings in Japan meet the Top Runner standards, while it corresponds to EISA in the U.S.
- ◎Can be driven by inverters as standard. Advanced magnetic-flux vector control by our FR-A800 achieves steady torque drive up to 0.5Hz.

#### Product Specifications

Number of poles	2-poles, 4-poles, 6-poles
Voltage·Frequency	200/200/220/230V 50/60/60/60Hz EISA 230V 60Hz or 400/400/440/460V 50/60/60/60Hz EISA 460V 60Hz
Exterior	Totally enclosed fan cooled type (inside, outside installation)
Protection system	IP44
Electrically-driven power system	Motor with 2-poles over 11kW is dedicated for a direct connection. Motors with 4-poles and 6-poles are for both direct and crossed belt connections.
Rotation direction	Counter-clock-wise (CCW) direction viewed from the edge of axis.
Compatible standard	JEC-2137-2000 (Efficiency is compatible with IEC 60034-30.)

Robot

MELFA F Series



High speed, high precision and high reliability industrial robot

- ◎Compact body and slim arm design, allowing operating area to be expanded and load capacity increased.
- ◎The fastest in its class using high performance motors and unique driver control technology.
- ◎Improved flexibility for robot layout design considerations.
- ◎Optimal motor control tuning set automatically based on operating position, posture, and load conditions.

#### Product Specifications

Degrees of freedom	Vertical:6	Horizontal:4
Installation	Vertical:Floor-mount, ceiling mount, wall mount (Range of motion for J1 is limited) Horizontal:Floor-mount	
Maximum load capacity	Vertical:2-20kg	Horizontal:3-20kg
Maximum reach radius	Vertical:504-1503mm	Horizontal:350-1,000mm

CNC

Mitsubishi Numerical Control Unit C70 Series



iQ Platform compatible CNC to provide TCO reduction effect.

- ◎A CNC structured in building block method on iQ Platform.
- ◎High performance CNC integrated with high-speed PLC offers high-speed control to reduce cycle time.
- ◎A wide variety of FA products helps construct flexible lines.

#### Product specifications

Maximum number of control axes (NC axis + spindle + PLC axis)	16 axes
Maximum number of part system	Machining center system: 7 systems, Lathe system: 3 systems
Maximum number of NC axes per part system	8 axes
Maximum program capacity	2,000 KB (5,120 m)
Maximum number of files to store	124 files/252 files
Number of input/output points	4,096 points
Safety observation function	Safety signal comparison function, speed monitoring function, duplexed emergency stop



Low Voltage Circuit Breakers | Mitsubishi WS-V Series Molded Case Circuit Breakers, Earth Leakage Circuit Breakers



Technologies based on long year experience realize more improved performance.

- ◎The new electronic circuit breakers can display various measurement items.
- ◎Improvement of breaking performance with new breaking technology “Expanded ISTAC”.
- ◎Compliance with global standard for panel and machine export.
- ◎Commoditization of internal accessories for shorter delivery time and stock reduction.

Product Specifications.

Frame	32-250A Frame
Applicable standard	Applicable to IEC, GB, UL, CSA, JIS and etc.
Expansion of UL listed product line-up	New line-up of 480VAC type with high breaking performance for SCCR requirement
Commoditization of internal accessories	Reduction of internal accessory types from 3 to 1
Commoditization for AC and DC circuit use	Common use of 32/63A frame in both AC and DC circuit
Compact size for easy to use	Thermal adjustable and electronic circuit breakers are same size as 250AF fixed type
Measuring Display Unit (MDU) breakers	MDU breakers measure, display and transmit energy date to realize energy management.

Magnetic Starter | MS-T Series



Exceed your expectations.

- ◎10A frame model is over 16% smaller with a width of just 36mm!!
- ◎New integrated terminal covers.
- ◎Reduce your coil inventory by up to 50%.
- ◎Be certified to the highest international levels while work is ongoing to gain other country.

Product specifications

Frame	10 A to 32 A
Applicable standards	Certification to various standards including IEC, JIS, CE, UL, TÜV, CCC.
Terminal cover	Standard terminal cover improves safety, simplifies ordering, and reduces inventory, etc.
Improved wiring	Wiring and operability are improved with streamlining wiring terminal BC specifications.
Operation coil rating	Wide range of operation coil ratings reduces number of coil types from 14 (N Series) to 7 types and simplifies selection.
Option units	Diverse lineup includes Auxiliary Contact Block, Operation Coil Surge Absorber Unit, Mechanical Interlock Unit.

## Global FA Centers

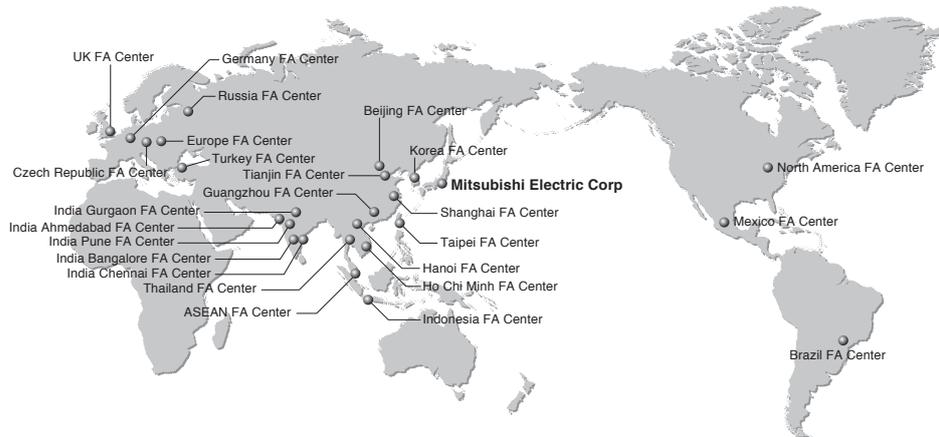

### China

**Shanghai FA Center**  
**MITSUBISHI ELECTRIC AUTOMATION (CHINA) LTD.**  
 No.1386 Hongqiao Road,  
 Mitsubishi Electric Automation Center,  
 Shanghai, China  
 Tel: 86-21-2322-3030 Fax: 86-21-2322-3000 (9611#)

**Beijing FA Center**  
**MITSUBISHI ELECTRIC AUTOMATION (CHINA) LTD. Beijing Branch**  
 Unit 901, 9F, Office Tower 1, Henderson Centre,  
 18 Jianguomennei Avenue, Dongcheng District,  
 Beijing, China  
 Tel: 86-10-6518-8830 Fax: 86-10-6518-2938

**Tianjin FA Center**  
**MITSUBISHI ELECTRIC AUTOMATION (CHINA) LTD. Tianjin Branch**  
 Room 2003 City Tower, No.35, Youyi Road,  
 Hexi District, Tianjin, China  
 Tel: 86-22-2813-1015 Fax: 86-22-2813-1017

**Guangzhou FA Center**  
**MITSUBISHI ELECTRIC AUTOMATION (CHINA) LTD. Guangzhou Branch**  
 Room 1609, North Tower, The Hub Center,  
 No.1068, Xingang East Road, Haizhu District,  
 Guangzhou, China  
 Tel: 86-20-8923-6730 Fax: 86-20-8923-6715

### Taiwan

**Taipei FA Center**  
**SETSUYO ENTERPRISE CO., LTD.**  
 3F, No.105, Wugong 3rd Road, Wugu District,  
 New Taipei City 24889, Taiwan, R.O.C.  
 Tel: 886-2-2299-9917 Fax: 886-2-2299-9963

### Korea

**Korea FA Center**  
**MITSUBISHI ELECTRIC AUTOMATION KOREA CO., LTD.**  
 7F-9F, Gangseo Hangang Xi-tower A, 401,  
 Yangcheon-ro, Gangseo-Gu, Seoul 157-801, Korea  
 Tel: 82-2-3660-9630 Fax: 82-2-3663-0475

### Thailand

**Thailand FA Center**  
**MITSUBISHI ELECTRIC FACTORY AUTOMATION (THAILAND) CO., LTD.**  
 12th Floor, SV.City Building, Office Tower 1,  
 No. 896/19 and 20 Rama 3 Road,  
 Kwaeng Bangpongpan, Khet Yannawa, Bangkok  
 10120, Thailand  
 Tel: 66-2682-6522 to 6531 Fax: 66-2682-6020

### ASEAN

**ASEAN FA Center**  
**MITSUBISHI ELECTRIC ASIA PTE. LTD.**  
 307, Alexandra Road, Mitsubishi Electric Building,  
 Singapore 159943  
 Tel: 65-6470-2480 Fax: 65-6476-7439

### Indonesia

**Indonesia FA Center**  
**PT. MITSUBISHI ELECTRIC INDONESIA Cikarang Office**  
 Jl. Kenari Raya Blok G2-07A Delta Silicon 5,  
 Lippo Cikarang - Bekasi 17550, Indonesia  
 Tel: 62-21-2961-7797 Fax: 62-21-2961-7794

### Vietnam

**Hanoi FA Center**  
**MITSUBISHI ELECTRIC VIETNAM COMPANY LIMITED Hanoi Branch**  
 6 - Floor, Detech Tower, 8 Ton That Thuyet Street,  
 My Dinh 2 Ward, Nam Tu Liem District, Hanoi,  
 Vietnam  
 Tel: 84-4-3937-8075 Fax: 84-4-3937-8076

**Ho Chi Minh FA Center**  
**MITSUBISHI ELECTRIC VIETNAM COMPANY LIMITED**  
 Unit 01-04, 10th Floor, Vincom Center, 72 Le  
 Thanh Ton Street, District 1, Ho Chi Minh City,  
 Vietnam  
 Tel: 84-8-3910-5945 Fax: 84-8-3910-5947

### India

**India Pune FA Center**  
**MITSUBISHI ELECTRIC INDIA PVT. LTD. Pune Branch**  
 Emerald House, EL -3, J Block, M.I.D.C Bhosari,  
 Pune - 411026, Maharashtra, India  
 Tel: 91-20-2710-2000 Fax: 91-20-2710-2100

**India Gurgaon FA Center**  
**MITSUBISHI ELECTRIC INDIA PVT. LTD. Gurgaon Head Office**  
 2nd Floor, Tower A & B, Cyber Greens, DLF  
 Cyber City, DLF Phase - III, Gurgaon - 122002  
 Haryana, India  
 Tel: 91-124-463-0300 Fax: 91-124-463-0399

**India Bangalore FA Center**  
**MITSUBISHI ELECTRIC INDIA PVT. LTD. Bangalore Branch**  
 Prestige Emerald, 6th Floor, Municipal No. 2,  
 Madras Bank Road (Lavelle Road), Bangalore -  
 560001, Karnataka, India  
 Tel: 91-80-4020-1600 Fax: 91-80-4020-1699

**India Chennai FA Center**  
**MITSUBISHI ELECTRIC INDIA PVT. LTD. Chennai Branch**  
 "Citilights Corporate Centre" No.1,  
 Vivekananda Road, Srinivasa Nagar, Chetpet,  
 Chennai - 600031, Tamil Nadu, India  
 Tel: 91-44-4554-8772 Fax: 91-44-4554-8773

**India Ahmedabad FA Center**  
**MITSUBISHI ELECTRIC INDIA PVT. LTD. Ahmedabad Branch**  
 B/4, 3rd Floor, Safal Profitaire, Corporate Road,  
 Prahaladnagar, Satellite, Ahmedabad,  
 Gujarat - 380015, India  
 Tel: 91-79-6512-0063 Fax: -

### America

**North America FA Center**  
**MITSUBISHI ELECTRIC AUTOMATION, INC.**  
 500 Corporate Woods Parkway, Vernon Hills,  
 IL 60061, U.S.A.  
 Tel: 1-847-478-2100 Fax: 1-847-478-2253

### Mexico

**Mexico FA Center**  
**MITSUBISHI ELECTRIC AUTOMATION, INC. Mexico Branch**  
 Mariano Escobedo #69, Col. Zona Industrial,  
 Tlalnepanitla Edo, C.P.54030, Mexico  
 Tel: 52-55-3067-7511 Fax: -

### Brazil

**Brazil FA Center**  
**MITSUBISHI ELECTRIC DO BRASIL COMÉRCIO E SERVIÇOS LTDA.**  
 Rua Jussara, 1750- Bloco B Anexo, Jardim Santa  
 Cecilia, CEP 06465-070, Barueri - SP, Brasil  
 Tel: 55-11-4689-3000 Fax: 55-11-4689-3016

### Europe

**Europe FA Center**  
**MITSUBISHI ELECTRIC EUROPE B.V. Polish Branch**  
 ul. Krakowska 50, 32-083 Balice, Poland  
 Tel: 48-12-630-47-00 Fax: 48-12-630-47-01

**Germany FA Center**  
**MITSUBISHI ELECTRIC EUROPE B.V. German Branch**  
 Gothaer Strasse 8, D-40880 Ratingen, Germany  
 Tel: 49-2102-486-0 Fax: 49-2102-486-1120

**UK FA Center**  
**MITSUBISHI ELECTRIC EUROPE B.V. UK Branch**  
 Travellers Lane, Hatfield, Hertfordshire, AL10  
 8XB, U.K.  
 Tel: 44-1707-28-8780 Fax: 44-1707-27-8695

**Czech Republic FA Center**  
**MITSUBISHI ELECTRIC EUROPE B.V. Czech Branch**  
 Avenir Business Park, Radlicka 751/113e,  
 158 00 Praha5, Czech Republic  
 Tel: 420-251-551-470 Fax: 420-251-551-471

**Russia FA Center**  
**MITSUBISHI ELECTRIC EUROPE B.V. Russian Branch St. Petersburg office**  
 Piskarevsky pr. 2, bld 2, lit "Sch", BC "Benua",  
 office 720; 195027, St. Petersburg, Russia  
 Tel: 7-812-633-3497 Fax: 7-812-633-3499

**Turkey FA Center**  
**MITSUBISHI ELECTRIC TURKEY A.Ş Ümraniye Branch**  
 Şerifali Mahallesi Nutuk Sokak No:5,  
 TR-34775 Ümraniye, İstanbul, Türkiye  
 Tel: 90-216-526-3990 Fax: 90-216-526-3995

Microsoft, Windows, Internet Explorer, and Windows Vista are either registered trademarks or trademarks of Microsoft Corporation in the United States and/or other countries.  
Celeron and Pentium are registered trademarks of Intel Corporation in the U.S. and/or other countries.  
Ethernet is a trademark of Xerox Corporation.  
All other company names and product names used in this document are trademarks or registered trademarks of their respective companies.

 **Safety Warning**

To ensure proper use of the products listed in this catalog,  
please be sure to read the instruction manual prior to use.

Mitsubishi Electric Corporation Nagoya Works is a factory certified for ISO14001 (standards for environmental management systems) and ISO9001(standards for quality assurance management systems)

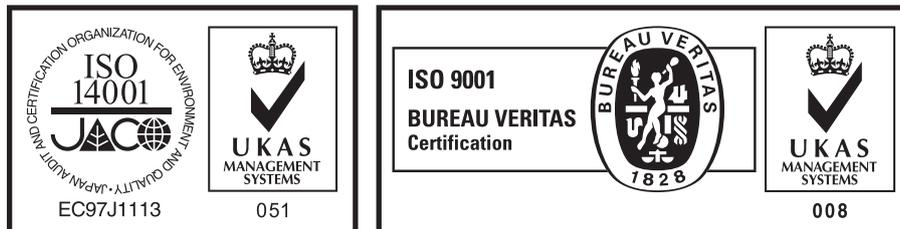

## MITSUBISHI ELECTRIC CORPORATION

HEAD OFFICE: TOKYO BUILDING, 2-7-3, MARUNOUCHI, CHIYODA-KU, TOKYO 100-8310, JAPAN  
 NAGOYA WORKS: 1-14, YADA-MINAMI 5, HIGASHI-KU, NAGOYA, JAPAN



**Siège Social & Agence Rhône-Alpes**  
 Parc Saint Exupéry  
 8, Rue Colonel Chambonnet  
 69500 Eron  
 Tél. : 04 72 14 18 00

Fax : 04 72 14 18 01

**Agence Paris Ile-de-France**  
 15, Rue Emile Baudot  
 Immeuble le Bergson  
 91300 Massy  
 Tél. : 01 69 29 87 30

info@ip-systemes.fr

**Agence Nord**  
 Village d'entreprises  
 ZI de Ruitz - Secteur des Hallots  
 62620 Ruitz  
 Tél. : 03 61 40 80 11

www.ip-systemes.fr

**Agence Ouest**  
 Centre Baya Axess  
 1, Rue du Guesclin  
 44019 Nantes  
 Tél. : 04 81 07 34 66

SOLUTIONS AUTOMATION & INFORMATIQUE INDUSTRIELLE