



**China (Shenzhen)**  
Shenzhen Cermate Technologies Inc.

TEL: +86-755-83562179  
E-MAIL: sa-cermate@cermate.com  
WEB: www.cermate.com.cn

**Taiwan**  
Cermate Technologies Inc.

TEL: +886-2-22437000  
E-MAIL: service@cermate.com  
WEB: www.cermate.com

**China (Shanghai)**  
Cermate (Shanghai) Technologies Inc.

TEL: +86-21-23570800/01/02  
E-MAIL: service01.sh@cermate.com  
QQ: 27025222833  
WEB: www.cermate.com.cn



Website



Driver list

Please verify specifications before quoting. This guide is intended for reference purposes only.  
All product specifications are subject to change without notice.  
No part of this publication may be reproduced in any form or by any means, electronic, photocopying, recording or otherwise, without prior written permission of the publisher.  
All brand and product names are trademarks or registered trademarks of their respective companies.  
© Cermate Technologies Inc. 2022

TPM-R40-A00-V0600

- IDCS
- PM Designer 4.0
- PanelExpress 4.0
- PanelVision
- HMI in Hand + IDCS Client
- IoT edge gateway - ES Box
- IoT HMI

# Cermate IoT Edge Solution

IoT tunnel / Intelligent connectivity



www.cermate.com

### IDCS (Inter-Device Connection Service)

The IDCS service is a dedicated IoT tunnel for remote monitoring and data collection.

#### Renewable Energy / ECS

- Real-time & safety monitoring
- Uninterrupted data collection to avoid data loss
- Reduce resource waste and protect the earth

#### Intelligent machine / smart factory

- Reduce on-site personnel and reduce equipment failure rate
- Safe and efficient real-time data transmission locally
- Real-time management of communication of various devices

#### Live farming / wireless IoT

- Remote wireless IoT monitoring reduces labor costs
- Real-time on-site monitoring achieves visual management
- The 3G/4G transmission extends the collection

#### Situation room / remote monitoring

- Remote multi-point equipment monitoring upload database system
- Real-time on-site alert push and quick troubleshooting
- Realize data analysis function and effective file management



Inter-Device Connection Service

## PANEL EXPRESS

Designed for Convenience



IT4 Series



ES Box



PT2 Series



ES Box



HMI in Hand



HMI in Hand



- IoT data protocol MQTT
- HMI Server
- E-Mail Sending alarm & notifications
- Mobile Phone Message SMS

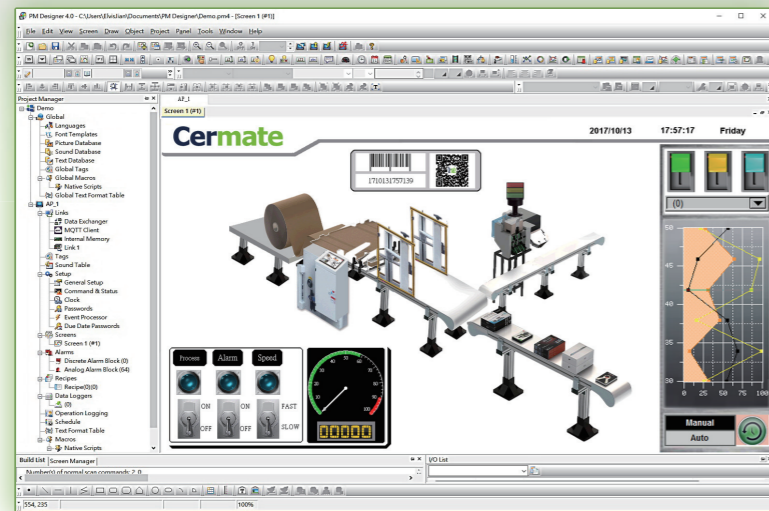

- Security Password & Due date password
- Multilanguage One application supports up to 30 languages
- Two-dimensional barcode Barcode & QR Code
- Gateway Service Data Exchanger

PM Designer is proven in many application fields and is an easy to use integrated development tool featuring solution-oriented screen objects, high-end vector graphics, Windows fonts for multi-language applications, recipes, alarms, data loggers and operation logging. PM Designer also includes online/offline simulation and other utility programs such as recipe editors and text editors. The newest PM Designer 4.0 is designed for IIoT, also supports remote data collection and transmission, like our IDCS(Inter-Device Connection Service) and MQTT protocol. PanelMaster runtime, a part of PM Designer, guarantees reliability and performance because of the minimum system overhead, high communication data rates, sub-second screen switching, and 24/7 operation.

Supported operating systems:



## PanelExpress 4.0

HMI runtime software for PC

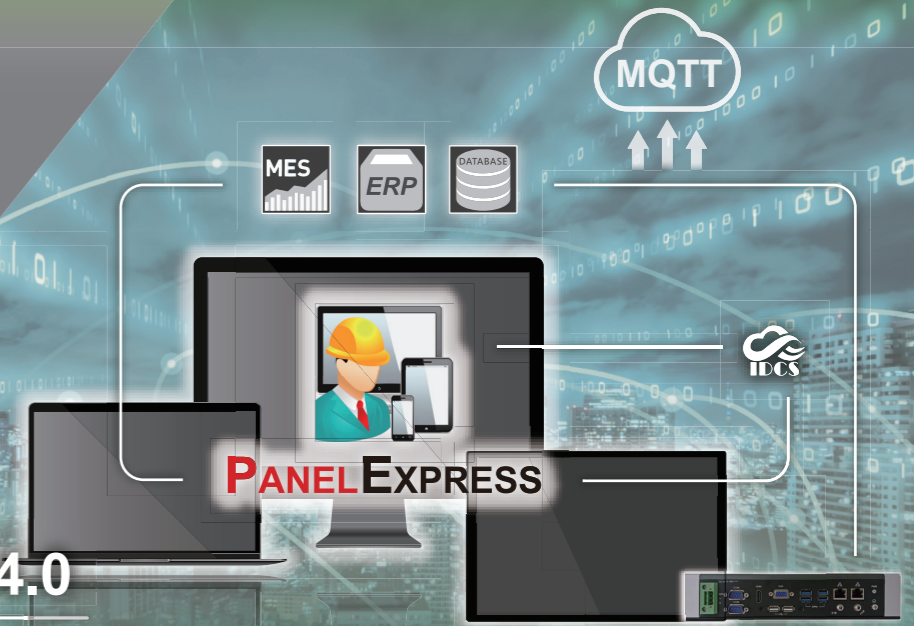

### >> Features

- |   |  |   |
|---|--|---|
| Built-in MQTT Client Supports mainstream cloud platform         | Seamless transmission for data temporary storage | Built-in IDCS Server  |
| Dashboard for central situation room / Displaying data analysis | Adopts safe encryption of upload data            | Integrated communication protocol / Data exchange   |
| Cost effective windows based HMI runtime                        | Supports VB Script and Microsoft JavaScript      | Provides a complete set of useful macro commands. Macro programs can be embedded in object, screens, and the global process |

### >> Optional features

- |                                     |   |   |
|-------------------------------------|---|---|
| Provides Excel/PDF report generator | Supports My SQL ; SQL ; Access and Oracle (Not available for Linux) | 3rd party containers function Supports Internet Explorer / Chromium and Firefox browser / Media Player / AutoCAD DWG Viewer |
| Multi window display                | OPC Server / OPC Client / HMI Server / VNC Server /                 | Database Visualization  |

### >> Ordering information

(Please contact us for detailed information about ordering)

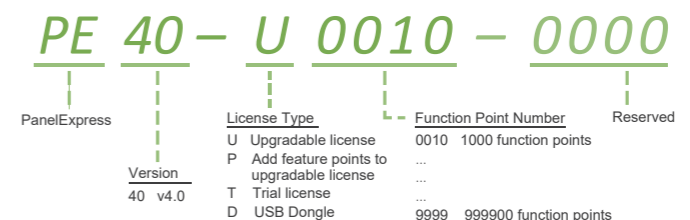



# PANELVISION

Remote / local devices controlling & monitoring  
Data management software

## >> Features

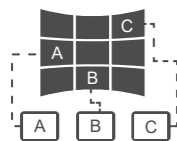

Multi-screen remote desktop real-time data collection

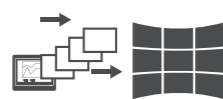

Display max—25 multi-screens for the same or different device applications



Supports connections between local & remote devices via IDCS

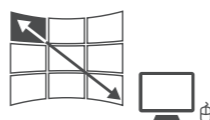

Showing single display on full screen with zoom in/out feature, and on TV



High-security & high-efficiency data collection



Data visualization & Intuitive analysis



Data controlling & monitoring

## >> Naming rules

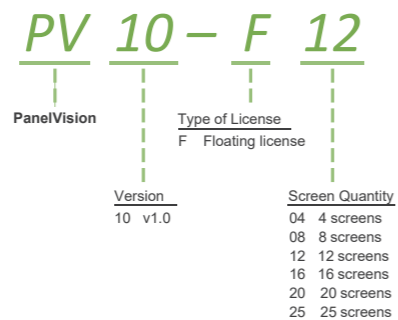

# HMI in Hand & IDCS Client

Mobile devices controlling & monitoring application /  
Real-time alarms notification application

## >> HMI in Hand



As digital signage displayed on a smart TV



Supports connections between local & remote devices via IDCS



Supports iOS & Android mobile devices



Data visualization & Intuitive analysis



Real-time data collection



Monitor and set data from a device

## >> IDCS Client



Receiving real-time alarms with pictures allows for quick management on field-site status



Supports iOS & Android mobile devices



## Smart factory

Data collection / Data synchronization /  
Data exchange / Mobile devices monitoring /  
Schedule management /  
Wireless network communication /  
Data visualization / Real-time alarms

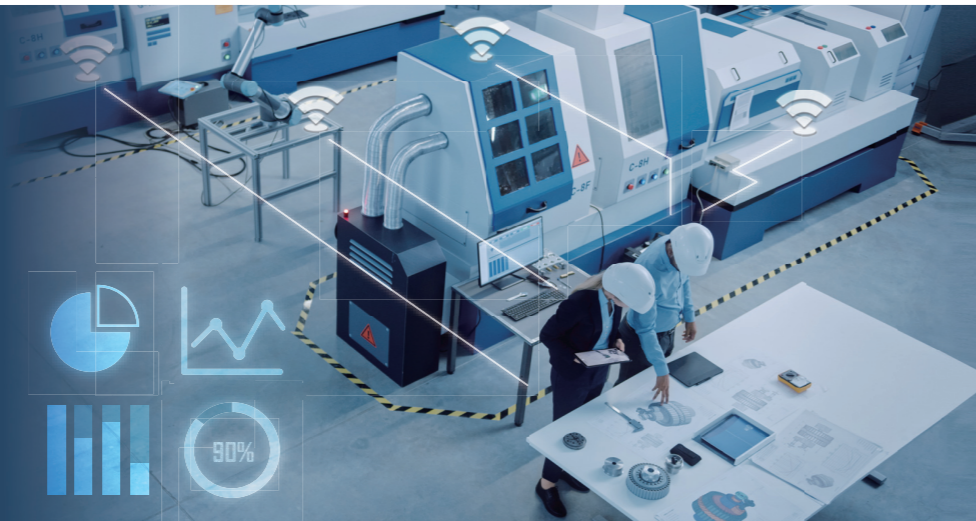

## Smart Agriculture

Data collection / Remote monitoring /  
Edge computing / Data setting /  
Wireless network communication /  
Real-time alarms / Video stream

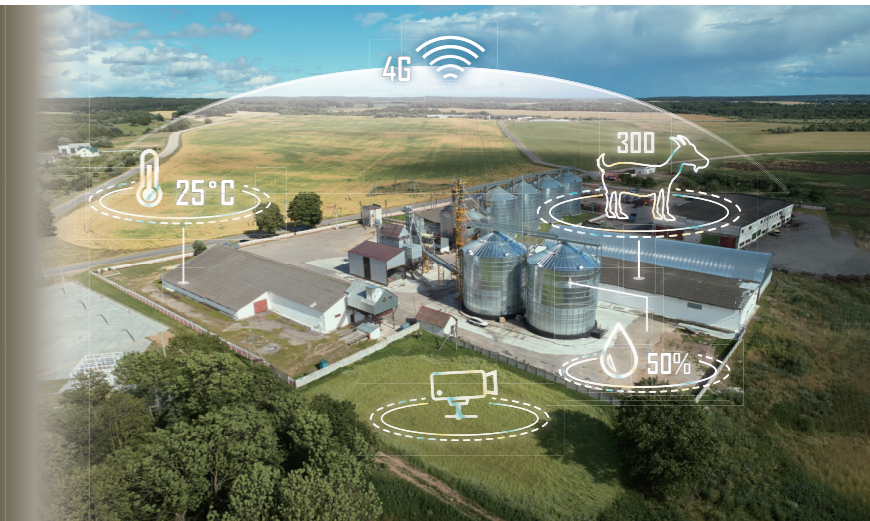

Send alarm through SMS,  
notification and E-mail

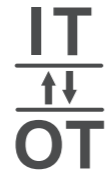

Integrated OT data to IT system



Using strict TLS encryption to  
secure data and prevent it  
from being hacked



Solving the problems for  
a shortage of manpower



Reducing management costs







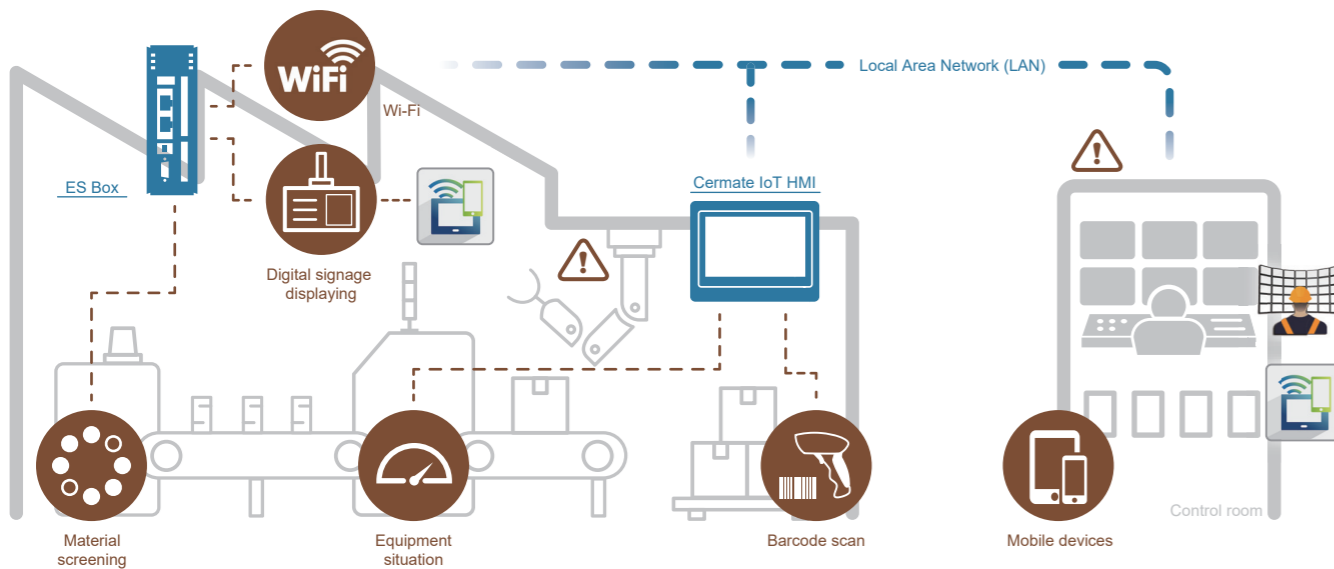

Monitoring at  
anytime and anywhere

### >> System architecture



### >> Related products

ES2 Series	IT400 Series	PT2 Series	PK2 Ethernet	PanelVision	HMI in Hand
					
P.9-10	P.11-12	P.13-14	P.15-16	P.5	P.6

### >> System architecture

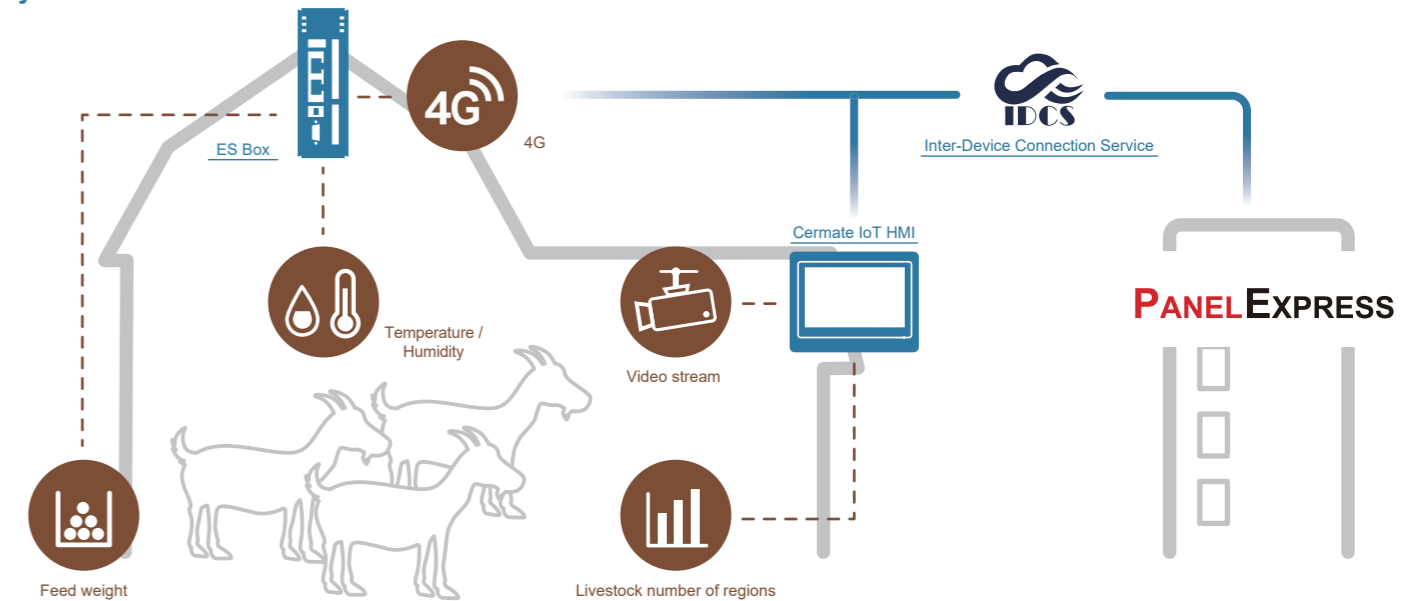

### >> Related products

ES2 Series	IT400 Series	PT2 Series	RM I/O module	PanelExpress
				
P.9-10	P.11-12	P.13-14	P.17	P.4

**ES Box**  (Dimension without the module and the antenna: 41.9 x 130.1 x 90.7mm)



Model name	ES20-1SNA02-C1R0	ES22-1HNA00-C1Q1	ES22-1HNA02-C1Q1
Working memory	128MB	128MB	128MB
Backup FRAM	0KB	128KB	128KB
Real-Time Clock (RTC)	Network time protocol (NTP)(Optional)	YES	YES
Communication interface	Micro SD slot	N/A	YES
	USB host	USB 2.0	USB 2.0
	USB client	USB 2.0	USB 2.0
	COM1	RS232/422/485 (DB9)	RS232/422/485 (DB9)
A side expansion	COM2	RS232 (DB9) & RS422/485 (5-Pin terminal)	RS485 (DB9)
	Ethernet	1 x RJ45	2 x RJ45 (Dual IP)
	COM3	RS232/422/485	N/A
	COM4	RS232	N/A
A side expansion	CAN Bus	N/A	N/A
	SIO (Safety signal contactor)	DI x 2 / DO x 2	N/A
	GIO (I/O port)	N/A	N/A
	Wi-Fi	N/A	N/A
4G / Wi-Fi module	N/A	N/A	N/A
B side expansion (Optional)	N/A	N/A	N/A
Input voltage	24VDC (Isolated)	12~36VDC (Isolated)	
Environment	Operating temperature	-10°C~60°C	
	Relative humidity	10%~90%	
	Shock (Operation)	Half sine, 20G, 11ms duration	
	Vibration (Operation)	Random vibration 1 Grms (5 ~ 500 Hz)	
FCC / CE	FCC (part 15 Class A) / CE (EN61000-6-2, EN61000-6-4)		
Net weight (g)	266.8 (±5%)	233 (±5%)	279.8 (±5%)
Software version	PM Designer v4.0.5.31 or higher version		

» B01 side

Model name	Channel	I/O type	Electrical specifications
Analog input	CH0	Voltage input	0.0~10.0VDC
	CH1		
	CH2		
	CH3		
Analog input	CH4	Current input	0.0~20.0mA
	CH5		
	CH6		
	CH7		
Digital input	CH8	Digital input	24VDC / 5mA
	CH9		
	CH10		
	CH11		
Digital output	CH12	Digital output	BJT(NPN/PNP):DC24V / 0.7A
	CH13		
	CH14		
	CH15		
	CH16		
	CH17		
Analog output	CH18	Voltage output	0.0~10.0VDC
	CH19		
	CH20		
	CH21		
Analog output	CH22	Current output	0.0~20.0mA
	CH23		

A side / B side expansion (Optional)

» A side



Model name	A01	A02	A03	A05
A side expansion	COM3	RS232/422/485 (DB9 male)	RS232/422/485 (DB9)	RS485 (Isolated)
	COM4	RS232	RS232	RS232 (Isolated)
	CAN Bus	N/A	N/A	8-Pin terminal: Pin6/7
	SIO (Safety signal contactor)	DI x 2 / DO x 2	DI x 2 / DO x 2	DI x 2 / DO x 2
	GIO (I/O port)	N/A	N/A	N/A
B side expansion (Optional)	Optional	Optional	Optional	Optional



Model name	A11	A12	A13	A21
A side expansion	COM3	RS232 (5-Pin terminal)	RS232 (5-Pin terminal)	Optional
	COM4	RS485 (5-Pin terminal)	RS485 (5-Pin terminal)	Optional
	CAN Bus	N/A	N/A	N/A
	SIO (Safety signal contactor)	DI x 2 / DO x 2	N/A	N/A
	GIO (I/O port)	In x 3 / Out x 3	DI x 5 / AI x 1	DI x 6 / DO x 2 / AI x 2
B side expansion (Optional)	N/A	N/A	N/A	Optional

» Naming rule

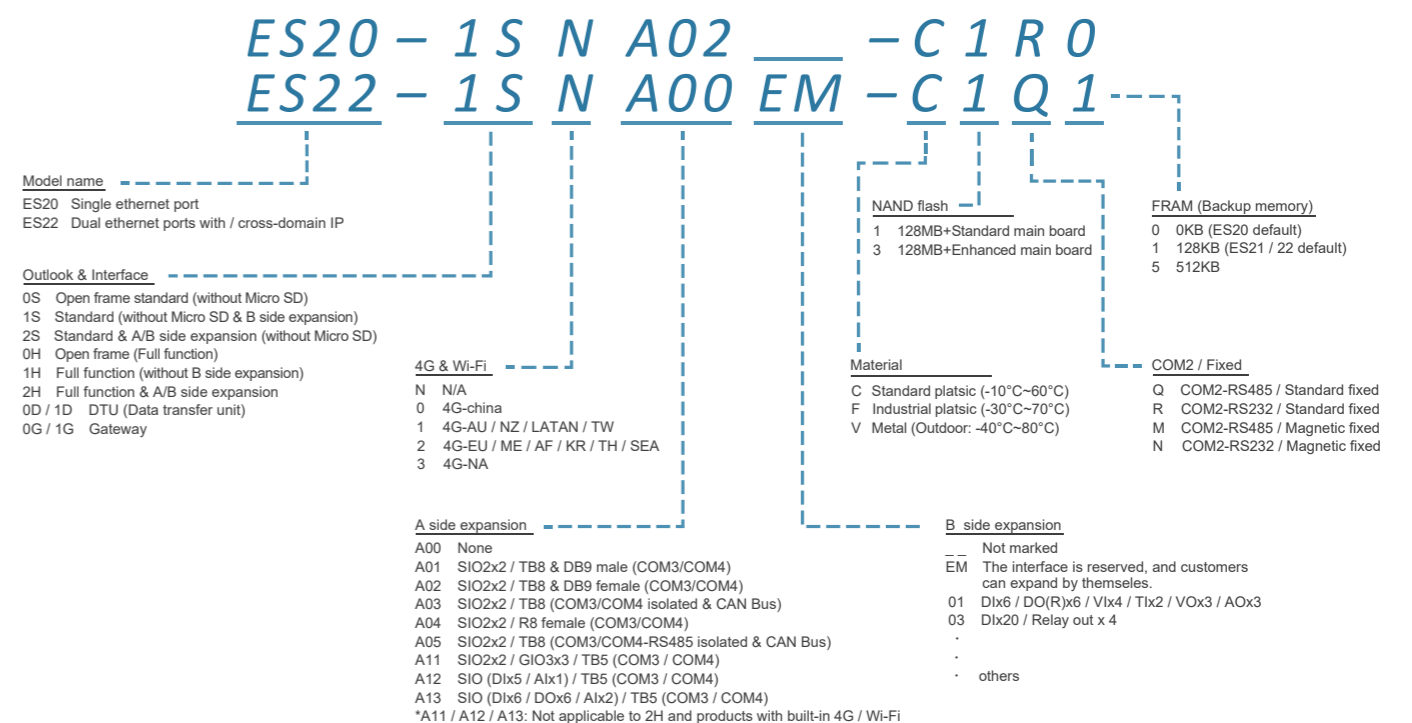

### IT400-22 Series



Model name		IT407-22ST(F)	IT407-22ST(L)	IT410-22ST	IT412-22ST	IT415-22ST
Display (LCD)	Size	7.0"	7.0"	10.1"	12.1"	15.0"
	Max. resolution	800*480	800*480	1024*600	1024*768	1024*768
	Type	TFT LCD with LED backlight				
	Max. color	16-bit				
	Backlight life (hr)	20,000		50,000		
	Luminance (cd/m2)	400	400	350	500	350
Touch panel		4-wire analog touch panel			5-wire analog touch panel	
CPU		RISC ARM9 32Bit				
Battery backup SRAM		1MB				
Working memory		128MB				
Application and data file memory		64MB				
Real-Time Clock (RTC)		YES (Unchargeable battery type, 5 years battery life)				
Max. programming pages		7999 pages				
Max. marco commands		Unlimited				
Communication interface	Micro SD slot	YES				
	USB host	USB 2.0				
	USB client	USB 2.0				
	COM port (5-Pin Terminal)	Standard for type B→ Com1: RS232 & Com2: RS485(5Pin-terminal) (Optional for type A→ Com2: RS422 or RS485 / type D→ Com1: RS485 & Com2: RS485 (5Pin-terminal))				
Power	Input voltage	24VDC±10%				
	Consumption	20W				
Environment	Temperature	Operating Temperature : -10°C~60°C / Storage Temperature: -20°C~70°C				
	Relative humidity	10%~90%				
	Shock (Operation)	Half sine, 20G, 11ms duration				
	Vibration (Operation)	Random vibration 1 Grms (5 ~ 500 Hz)				
	FCC	FCC Part 15 Class A				
	CE	EN61000-6-2, EN61000-6-4				
	Ingress protection	IP66				
	Cooling	Natural Cooling				
Dimension WxHxD (mm)		189.6 x 144.9 x 30.6	203.8 x 148.8 x 31.6	270.1 x 212.1 x 37.98	335.4 x 245.8 x 60.9	399.1 x 297.6 x 57.9
Cutout dimension AxB (mm)		175 x 132.5	191.5 x 138	259 x 201	302 x 228	384.5 x 283
Net weight (Kg)		0.5	0.55	1.1	2	3
Software version		PM Designer v4.0				

#### » Rear case



#### » Accessories



#### » Outlet dimension

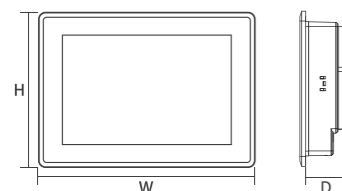

#### » Cutout dimension

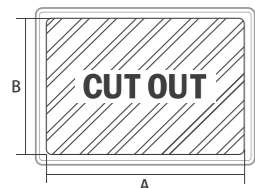

#### » Naming rule

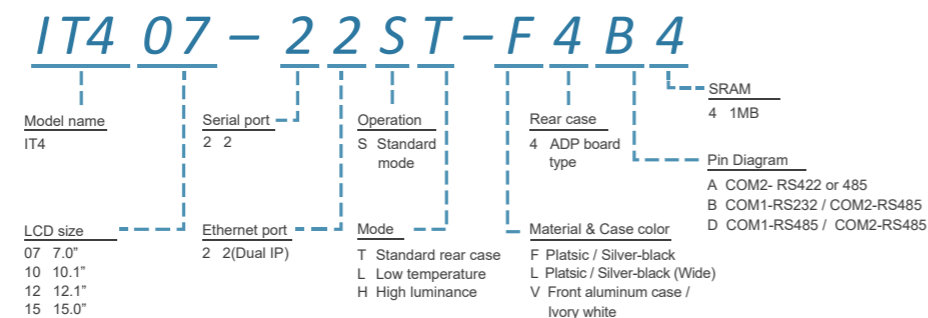

### PX Series



Model name		PX070-WST	PX080-TST	PX104-TST	PX121-XSD	PX151-XSD
Sub model		4 / 5 / 6	4 / 5 / 6	4 / 5 / 6	4 / 5 / 6	4 / 5 / 6
Display (LCD)	Size	7.0"	8.0"	10.4"	12.1"	15.0"
	Max. resolution	800*480	800*600	800*600	1024*768	1024*768
	Type	TFT LCD with LED backlight				
	Max. color	16-bit				
	Backlight life (hr)	20,000		50,000		
	Display contrast	500	500	400	700	700
Luminance (cd/m2)	300	250	400	500	350	
Touch panel		4-wire analog touch panel			5-wire analog touch panel	
CPU		RISC ARM11 800HMz				
Battery backup SRAM		1MB				
Working memory		256MB				
Application and data file memory		1GB				
Real-Time Clock (RTC)		YES (Rechargeable)				
Max. programming pages		7999 pages				
Max. marco commands		Unlimited				
Communication interface	Micro SD slot	YES				
	USB host	USB 1.1				
	USB client	USB 2.0				
	COM1	RS232/422/485 (DB9)				
	COM2	Type A-RS422/485	Type B-RS232/485	Type C-RS232 with RTS&CTS (5-Pin Terminal)		
	COM3	RS232 (DB9) (Optional:RS485)				
COM4	Sub model 6: RS422/485 (5-Pin Terminal)					
COM5	N/A					
Ethernet	YES					
Front function keys		N/A				
Audio out		Sub model 5 / 6: YES				
Video in		Sub model 6: YES (With an analog color camera)				
Front USB host port		N/A				
Power	Input voltage	24VDC±10%				
	Consumption	20W				
Environment	Operating temperature	-10°C~60°C				
	Relative humidity	10%~90%				
	Shock (Operation)	Half sine, 20G, 11ms duration				
	Vibration (Operation)	Random vibration 1 Grms (5 ~ 500 Hz)				
	FCC	FCC Part 15 Class A				
	CE	EN61000-6-2, EN61000-6-4				
	UL	UL508				
	Ingress protection	IP66				
Cooling	Natural Cooling					
Dimension WxHxD (mm)		213.6 x 158.6 x 51	241.6 x 184.6 x 56.2	280.3 x 222.3 x 56.5	317.4 x 243.8 x 72.2	399.1 x 297.6 x 71.5
Cutout dimension AxB (mm)		191.5 x 138	221 x 163.5	259 x 201	302 x 228	384.5 x 283
Net weight (Kg)		0.61	1.1	1.41	2.2	3

#### » Outlet dimension

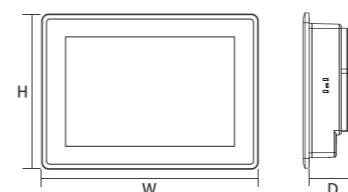

#### » Cutout dimension

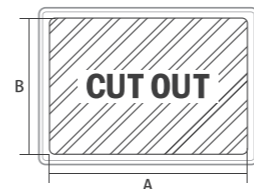

#### » Naming rule

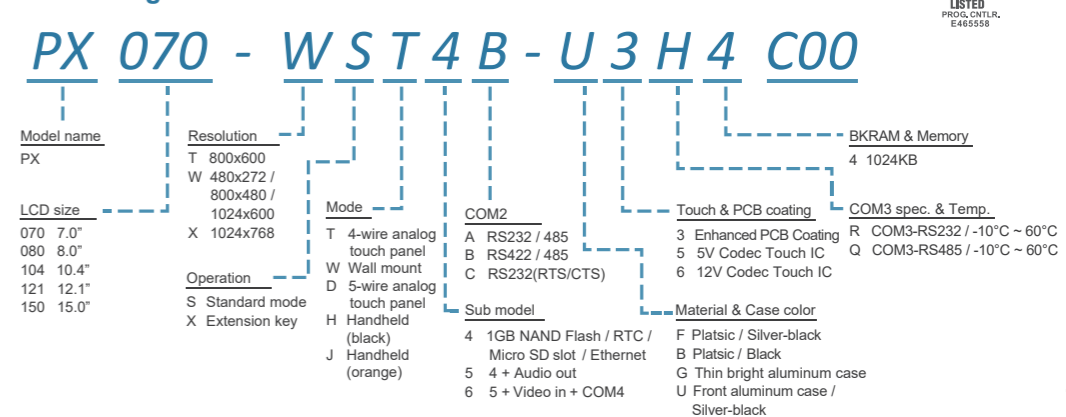

PT2 Series



Model name		PT2043-41ST	PT2070-51ST	PT2080-51ST
Display (LCD)	Size	4.3"	7.0"	8.0"
	Max. resolution	480*272	800*480	800*600
	Type	TFT LCD with LED backlight		
	Max. color	16-bit		
	Backlight life (hr)	20,000		
	Luminance (cd/m2)	400	400	250
Touch panel		4-wire analog touch panel		
CPU		RISC ARM9 32Bit		
Battery backup SRAM		128KB (Optional:1024KB)		
Working memory		64MB		
Application memory		Approximately 40MB		
Data file memory		64MB		
Real-Time Clock (RTC)		YES (Unchargeable battery type, 5 years battery life)		
Max. programming pages		7999 pages		
Max. marco commands		Unlimited		
Communication interface	Micro SD slot	N/A		
	USB host	USB 2.0		
	USB client	USB 2.0		
	COM1	RS232 (5-Pin Terminal)	RS232 (DB9)	
	COM2	RS485 (5-Pin Terminal)	RS422/485 (DB9)	
	COM3	RS485 (5-Pin Terminal)	RS485 (DB9)	
	COM4	RS485 (5-Pin Terminal)	RS485 (5-Pin Terminal)	
	COM5	N/A	RS485 (5-Pin Terminal)	
Ethernet		YES		
Front function keys		N/A	N/A (Optional)	N/A
Audio out		N/A		
Video in		N/A		
Front USB host port		N/A	N/A (Optional)	N/A
Power	Input voltage	24VDC±10%		
	Consumption	10W	20W	
Environment	Operating temperature	-10°C~60°C (Optional for BR2450A battery: -20°C~70°C)		
	Relative humidity	10%~90%		
	Shock (Operation)	Half sine, 20G, 11ms duration		
	Vibration (Operation)	Random vibration 1 Grms (5 ~ 500 Hz)		
	FCC	FCC Part 15 Class A		
	CE	EN61000-6-2, EN61000-6-4		
	UL	UL61010		
	Ingress protection	NEMA Type 4X / IP66		
Cooling		Natural Cooling		
Dimension WxHxD (mm)		129 x 103 x 33	203.8 x 148.8 x 37.1	231.6 x 176.3 x 43.4
Cutout dimension AxB (mm)		118.5 x 92.5	191.5 x 138	221 x 163.5
Net weight (Kg)		0.23	0.55	1



»» Outlet dimension

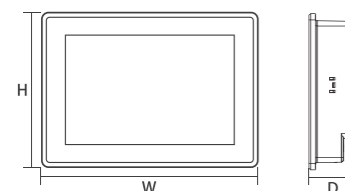

»» Cutout dimension

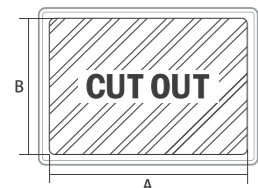

»» Naming rule

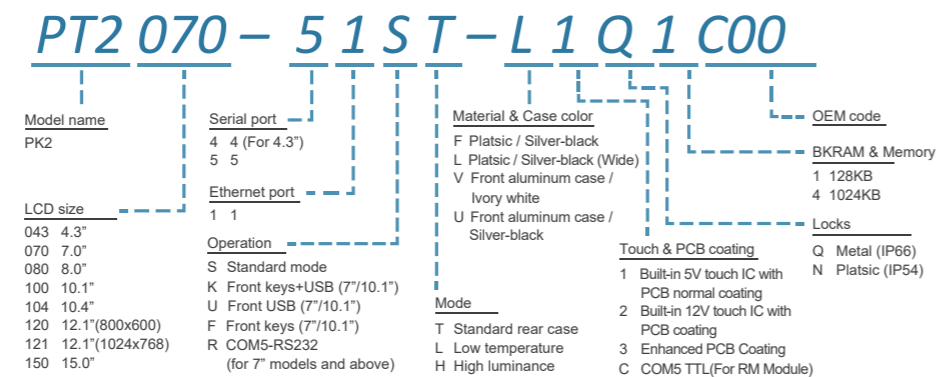

Model name		PT2100-51ST	PT2104-51ST	PT2121-51ST	PT2150-51ST
Display (LCD)	Size	10.1"	10.4"	12.1"	15.0"
	Max. resolution	1024*600	800*600	1024*768	1024*768
	Type	TFT LCD with LED backlight			
	Max. color	16-bit			
	Backlight life (hr)	20,000		50,000	
	Luminance (cd/m2)	350	400	500	350
Touch panel		4-wire analog touch panel			
CPU		RISC ARM9 32Bit			
Battery backup SRAM		128KB (Optional:1024KB)			
Working memory		64MB			
Application memory		Approximately 40MB			
Data file memory		64MB			
Real-Time Clock (RTC)		YES (Unchargeable battery type, 5 years battery life)			
Max. programming pages		7999 pages			
Max. marco commands		Unlimited			
Communication interface	Micro SD slot	N/A			
	USB host	USB 2.0			
	USB client	USB 2.0			
	COM1	RS232 (DB9)			
	COM2	RS422/485 (DB9)			
	COM3	RS485 (DB9)			
	COM4	RS485 (5-Pin Terminal)			
	COM5	RS485 (5-Pin Terminal)			
Ethernet		YES			
Front function keys		N/A (Optional)	N/A	N/A	N/A
Audio out		N/A			
Video in		N/A			
Front USB host port		N/A (Optional)	N/A	N/A	N/A
Power	Input voltage	24VDC±10%			
	Consumption	20W			
Environment	Operating temperature	-10°C~60°C (Optional for front aluminum case + BR2450A battery: -20°C~70°C)			
	Relative humidity	10%~90%			
	Shock (Operation)	Half sine, 20G, 11ms duration			
	Vibration (Operation)	Random vibration 1 Grms (5 ~ 500 Hz)			
	FCC	FCC Part 15 Class A			
	CE	EN61000-6-2, EN61000-6-4			
	UL	UL61010			
	Ingress protection	NEMA Type 4X / IP66			
Cooling		Natural Cooling			
Dimension WxHxD (mm)		270.1 x 212.1 x 43.48	270.1 x 212.1 x 43.48	335.4 x 245.8 x 66.4	339.1 x 297.6 x 63.4
Cutout dimension AxB (mm)		259 x 201	259 x 201	302 x 228	384.5 x 283
Net weight (Kg)		1.1	1.1	2	3



»» Accessories



**HMB-CER-018**  
Converter  
(For 7" models and above)  
(RS232 / RS422 / RS485)



**FCB-XD0-A001**  
5Pin Terminal to DB9 Female Cable  
(For 4.3" models)



**FCB-XD0-023**  
USB download cable for HMI



### PK2 Ethernet Models



Model name		PK2043-31ST	PK2070-31ST	PK2080-31ST
Display (LCD)	Size	4.3"	7.0"	8.0"
	Max. resolution	480*272	800*480	800*600
	Type	TFT LCD with LED backlight		
	Max. color	16-bit		
	Backlight life (hr)	20,000		
	Luminance (cd/m2)	400	400	250
Touch panel		4-wire analog touch panel		
CPU		RISC ARM9 32Bit		
Battery backup SRAM		128KB (Optional:1024KB)		
Working memory		64MB		
Application memory		Approximately 40MB		
Data File memory		64MB		
Real-Time Clock (RTC)		YES (Unchargeable battery type, 3 years battery life)		
Max. programming pages		7999 pages		
Max. marco commands		Unlimited		
Communication interface	Micro SD slot	N/A		
	USB host	USB 2.0		
	USB client	USB 2.0		
	COM1	RS232 (5-Pin Terminal)	RS232 (DB9)	
	COM2	RS422/485 (5-Pin Terminal)	RS422/485 (DB9)	
	COM3	RS485 (5-Pin Terminal)	RS485 (DB9)	
	COM4	N/A		
	COM5	N/A		
Ethernet		YES		
Front function keys		N/A	N/A (Optional)	N/A
Audio out		N/A		
Video in		N/A		
Front USB host port		N/A	N/A (Optional)	N/A
Power	Input voltage	24VDC±10%		
	Consumption	10W	20W	
Environment	Operating temperature	-10°C~60°C		
	Relative humidity	10%~90%		
	Shock (Operation)	Half sine, 20G, 11ms duration		
	Vibration (Operation)	Random vibration 1 Grms (5 ~ 500 Hz)		
	FCC	FCC Part 15 Class A		
	CE	EN61000-6-2, EN61000-6-4		
	UL	N/A		
	Ingress protection	IP65		
Cooling		Natural Cooling		
Dimension WxHxD (mm)		129 x 103 x 33	203.8 x 148.8 x 31.6	231.6 x 176.3 x 37.9
Cutout dimension AxB (mm)		118.5 x 92.5	191.5 x 138	221 x 163.5
Net weight (Kg)		0.23	0.55	1



#### »» Outlet dimension

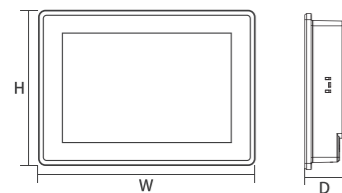

#### »» Cutout dimension

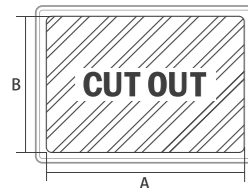

#### »» Naming rule

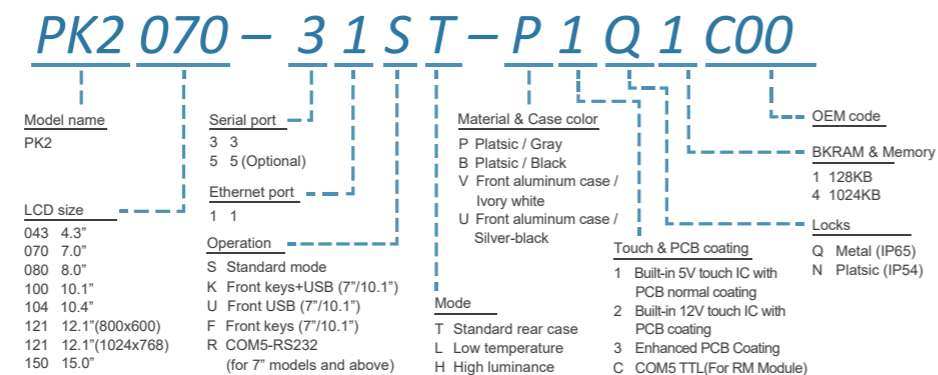

Model name		PK2100-31ST	PK2104-31ST	PK2121-31ST	PK2150-31ST
Display (LCD)	Size	10.1"	10.4"	12.1"	15.0"
	Max. resolution	1024*600	800*600	1024*768	1024*768
	Type	TFT LCD with LED backlight			
	Max. color	16-bit			
	Backlight life (hr)	20,000		50,000	
	Luminance (cd/m2)	350	400	500	350
Touch panel		4-wire analog touch panel			
CPU		RISC ARM9 32Bit			
Battery backup SRAM		128KB (Optional:1024KB)			
Working memory		64MB			
Application memory		Approximately 40MB			
Data File memory		64MB			
Real-Time Clock (RTC)		YES (Unchargeable battery type, 3 years battery life)			
Max. programming pages		7999 pages			
Max. marco commands		Unlimited			
Communication interface	Micro SD slot	N/A			
	USB host	USB 2.0			
	USB client	USB 2.0			
	COM1	RS232 (DB9)			
	COM2	RS422/485 (DB9)			
	COM3	RS485 (DB9)			
	COM4	N/A			
	COM5	N/A			
Ethernet		YES			
Front function keys		N/A (Optional)	N/A	N/A	N/A
Audio out		N/A			
Video in		N/A			
Front USB host port		N/A (Optional)	N/A	N/A	N/A
Power	Input voltage	24VDC±10%			
	Consumption	20W			
Environment	Operating temperature	-10°C~60°C			
	Relative humidity	10%~90%			
	Shock (Operation)	Half sine, 20G, 11ms duration			
	Vibration (Operation)	Random vibration 1 Grms (5 ~ 500 Hz)			
	FCC	FCC Part 15 Class A			
	CE	EN61000-6-2, EN61000-6-4			
	UL	N/A			
	Ingress protection	IP65			
Cooling		Natural Cooling			
Dimension WxHxD (mm)		270.1 x 212.1 x 37.98	270.1 x 212.1 x 37.98	335.4 x 245.8 x 60.9	339.1 x 297.6 x 57.9
Cutout dimension AxB (mm)		259 x 201	259 x 201	302 x 228	384.5 x 283
Net weight (Kg)		1.1	1.1	2	3



#### »» Accessories



**HMB-CER-018**  
Converter  
(For 7" models and above)  
(RS232 / RS422 / RS485)



**FCB-XD0-A001**  
5Pin Terminal to DB9 Female Cable  
(For 4.3" models)



**FCB-XD0-023**  
USB download cable for HMI

### RM Series



RM01-I4A1	Input	Rated voltage	Rated current	Maximum load voltage / current
	Dlx4 (NPN / PNP)	DC24V	7mA	30V / 50mA
	Current input	Input current range		
Alx1	0-20mA			



RM02-I8R8	Input	Rated voltage	Rated current	Maximum load voltage / current
	Dlx8 (NPN / PNP)	DC24V	7mA	30V / 50mA
	Output	Rated voltage	Rated current	Maximum load current
DOx8 (Relay)	AC250V / DC30V	1mA	5A	



RM03-A4V4C4U4	Voltage input	Input voltage range	Current input	Input current range
	Vlx4	DC0V-DC10V	Alx4	0-20mA
	Voltage output	Output voltage range	Current output	Output current range
VOx4	DC0V-DC10V	AOx4	0-20mA	

#### » Naming rule

**RM01 - XXXXXXXXXX - P 1**

Serial number  
01-99

There is a limit of 10 codes for the code name. The substitute codes will be used if the codes are exceeded.

Even number position: the quantity			
Odd number position			
DI	AI	DO	AO
T NPN / PNP	A Current input	R Relay	C Current output
H HSC	V Voltage input	Q Crystal PNP	U Voltage output
	T Temperature	N Crystal NPN	
		P Photocoupler	



PCB type

- 1 8 I/O without ADP
- 2 5 I/O without ADP
- 3 8 I/O with ADP
- 4 5 I/O with ADP

Material & Case color

- P Platic / Gray
- F Platic / Silver-black
- V Platic / Ivory white

#### » Compatible Products (Rear case with ADP board type for PT2/PK2 series)

IT4-22 Series	PT2 Series	PK2 Ethernet Model
		
P.11	P.13-14	P.15-16

### PK2 Serial Models



Model name	PK2043-30ST	PK2070-30ST	PK2100-30ST	
Display (LCD)	Size	4.3"	7.0"	10.1"
	Max. resolution	480*272	800*480	1024*600
	Type	TFT LCD with LED backlight		
	Max. color	16-bit		
	Backlight life (hr)	20,000		
	Luminance (cd/m2)	400	400	350
Touch panel	4-wire analog touch panel			
CPU	RISC ARM9 32Bit			
Battery backup SRAM	128KB (Optional:1024KB)			
Working memory	64MB			
Application memory	Approximately 40MB			
Data File memory	64MB			
Real-Time Clock (RTC)	YES (Unchargeable battery type, 3 years battery life)			
Max. programming pages	7999 pages			
Max. marco commands	Unlimited			
Communication interface	Micro SD slot	N/A		
	USB host	USB 2.0		
	USB client	USB 2.0		
	COM1	RS232 (5-Pin Terminal)	RS232 (DB9)	RS232 (DB9)
	COM2	RS422/485 (5-Pin Terminal)	RS422/485 (DB9)	RS422/485 (DB9)
	COM3	RS485 (5-Pin Terminal)	RS485 (DB9)	RS485 (DB9)
	COM4	N/A		
	COM5	N/A		
Ethernet	N/A			
Front function keys	N/A	N/A (Optional)	N/A (Optional)	
Audio out	N/A			
Video in	N/A			
Front USB host port	N/A	N/A (Optional)	N/A (Optional)	
Power	Input voltage	24VDC±10%		
	Consumption	10W	20W	20W
Environment	Operating temperature	-10°C~60°C		
	Relative humidity	10%~90%		
	Shock (Operation)	Half sine, 20G, 11ms duration		
	Vibration (Operation)	Random vibration 1 Grms (5 ~ 500 Hz)		
	FCC	FCC Part 15 Class A		
	CE	EN61000-6-2, EN61000-6-4		
	UL	N/A		
	Ingress protection	IP65		
Cooling	Natural Cooling			
Dimension WxHxD (mm)	129 x 103 x 33	203.8 x 148.8 x 31.6	270.1 x 212.1 x 37.98	
Cutout dimension AxB (mm)	118.5 x 92.5	191.5 x 138	259 x 201	
Net weight (Kg)	0.23	0.55	1.1	



#### » Outlet dimension

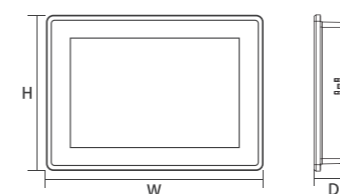

#### » Cutout dimension

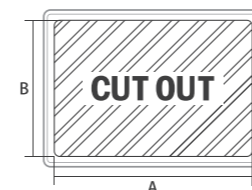

#### » Naming rule

**PK2 070 - 30ST - P 1 Q 1 C00**

Model name	Serial port	Ethernet port	LCD size	Operation	Material & Case color	Mode	Touch & PCB coating	OEM code	Locks
PK2	3 3	0 0	043 4.3" 070 7.0" 100 10.1"	S Standard mode K Front keys+USB (7"/10.1") U Front USB (7"/10.1") F Front keys (7"/10.1") R COM3-RS232 (7"/10.1")	P Platic / Gray B Platic / Black	T Standard rear case L Low temperature H High luminance	1 Built-in 5V touch IC with PCB normal coating 3 Enhanced PCB Coating	BKRAM & Memory 1 128KB 4 1024KB	Q Metal (IP65) N Platic (IP54)