

## FnIO G-Series:



# GN-9481 / GN-9482 / GN-9483

*EtherCAT, Modbus Programmable I/O*



# Specification

## 1. ENVIRONMENT SPECIFICATION

<b>Environmental specification</b>	
Operating Temperature	-20°C~60°C
UL Temperature	-20°C~60°C
Storage Temperature	-40°C~85°C
Relative Humidity	5% ~ 90% non-condensing
Mounting	DIN rail
<b>Vibration Resistance</b>	
EMC Resistance Burst/ESD	IEC 60068-2-27
Installation Pos. / Protect. Class	Based on IEC 60068-2-6 Sine Vibration 5 ~ 25Hz : 1.6mm 25 ~ 300Hz : 4g Sweep Rate : 1 Oct/min, 20 cycles Random Vibration 10 ~ 40Hz : 0.0125g <sup>2</sup> /Hz 40 ~ 100Hz : 0.0125 → 0.002g <sup>2</sup> /Hz 100 ~ 500Hz : 0.002g <sup>2</sup> /Hz 500 ~ 2000Hz : 0.002 → 1.3 x 10 <sup>-4</sup> g <sup>2</sup> /Hz Test time : 1 hours for each test
Product Certifications	EN 61000-6-2 : 2005 EN 61000-6-4/A11 : 2011
Installation Pos. / Protect. Class	Variable/IP20
Product Certifications	FCC, KC, UL, RoHS2

# Specification

## 2. GN-9481/9482/9483 (G-Series EtherCAT PROGRAMMABLE I/O)

### 2.1. GN-9481/9482/9483 Specification

Items		Specification	
<b>Programmable Specification</b>			
Programming		CoDeSys V3.5.11.3	
Program Memory	GN-9481 *	512 KBytes	
	GN-9482/9483	16 MBytes	
Data Memory	GN-9481	96 KBytes	IO Input: %IW0 ~%IW2047 (2048 words) IO Output: %QW0 ~%QW2047 (2048 words) Memory: %MW0 ~%MW8191 (8192 words)
	GN-9482/9483	16 MBytes	
Non-Volatile Memory	GN-9481	4 KBytes (Retain : 2 KBytes, Flag : 2 KBytes)	
	GN-9482/9483	32 KBytes (Retain : 16KBytes, Flag : 16 KBytes)	
Run-Time System		Multiple PLC Tasks	
Program Languages		IEC 61131-3 (LD, IL, ST, FBD, SFC)	
OPC-Server	GN-9481	Not supporting	
	GN-9482/9483	DA	
Online Change	GN-9481	Not supporting	
	GN-9482/9483	Supporting	
Source Upload/Download	GN-9481	Not supporting	
	GN-9482/9483	Supporting	
File transmit	GN-9481	Not supporting	
	GN-9482/9483	Supporting	
Breakpoint	GN-9481	Not supporting	
	GN-9482/9483	Supporting	
Webvisualization	GN-9481/9482	Not supporting	
	GN-9483	Supporting	
RTC	GN-9481	Retain Time : < 15 day	Accuracy : < 2min/month
	GN-9482/9483	Retain Time : < 15 day	
Max. Task		10	
Max. Cycle Task		10	
Max. Status Task		10	
Process Time	GN-9481	1usec (90 Instructions)	
	GN-9482/9483	7usec (90 Instructions)	

# Specification

Interface Specification	
<b>Ethernet</b>	
Adapter Type	Master & Slave Node (Modbus TCP, Modbus RTU)
Baud rate	10/100Mbps, Auto-negotiation, Full Duplex
Interface	RJ-45 socket * 1pcs
Ethernet Protocol**	Modbus/TCP, Modbus/UDP, SNTP HTTP (Webvisualization***, Web-Server), DHCP/BOOTP, OPC-server
Max. Nodes	Limited by Ethernet Specification
Max. Socket	24 (UDP: 8, TCP: 16, TCP_LISTEN: 10)
Support	Input Size [ 256 Byte ] / Output Size [ 256 Byte ] RxPDO [ 64 Byte ] / TxPDO [ 64 Byte ] Moduler Type / Non-Moduler Type
<b>EtherCAT</b>	
Adapter Type	Slave Node
Baud rate	100Mbps
Interface	RJ-45 socket * 2pcs
Max. Size	Moduler            The maximum size is adjusted according to the IO size. Non-Moduler      256 bytes.
EtherCAT Protocol	EtherCAT Slave
Max. Network Nodes	65,535
<b>Common</b>	
Max. Expansion Module	63 Slots
Max. Data Size(Input+Output)	Max 128Byte each slot
Serial Interface	RS232/RS485 2port (supporting Touch Panel)
Serial Protocol	Modbus/RTU / Baud Rate : 2400~115200 bps (Default: 115200 bps)
Indicator	6 LEDs 1 Green/Red, Module Status (MOD) 1 Green/Red, Network Status (NET) 1 Green/Red, PLC Run/Stop Status (RUN) 1 Green/Red, Expansion I/O Module Status (IOS) 1 Green, System Power Status 1 Green, Field Power Status
<b>General specification</b>	
System Power	Supply voltage : 24Vdc nominal Supply voltage range : 15~32Vdc Protection : Output current limit (Min. 1.5A) / Reverse polarity protection
Power Dissipation	110mA typical @ 24Vdc
Current for I/O Module	1.5A @ 5Vdc
Isolation	System power to internal logic : Non-isolation System power I/O driver : Isolation
Field Power	Supply voltage : 24Vdc typical (Max. 32Vdc) * Field Power Range is different depending on IO Module series. Refer to IO Module's Specification.
Max Current Field Power Contact	DC 10A Max
Weight	<167g
Module Size	54mm x 99mm x 70mm
<b>Environment Condition</b>	<b>Refer to '1. Environment Specification'</b>

\* GN-9481 is an economic version derived from GN-9482.

\*\*\* Webvisualization cannot be supported in Internet Explorer.

# Specification

## 2.2. GN-9481/9482/9483 Ethernet connection specification

Function*	Model	Max. number of concurrent communications
Webvisualization	GN-9483 only	One for each functions are available at the same time
ARTI (OPC-server)	GN-9482/83	
CoDeSys link	GN-9481/82/83	
Network-variable	GN-9481/82/83	
Modbus/TCP Master	GN-9481/82/83	5 Modbus/TCP Slaves can be connected
Modbus/TCP Slave	GN-9481/82/83	16 Modbus/TCP Masters can be connected
EtherCAT Slave	GN-9481/82/83	
Web-server	GN-9481/82/83	16 clients can be opened

\* While using these functions, 16 sockets are available at the same time.

# Specification

## 2.3. GN-9481/9482/9483 Wiring Diagram

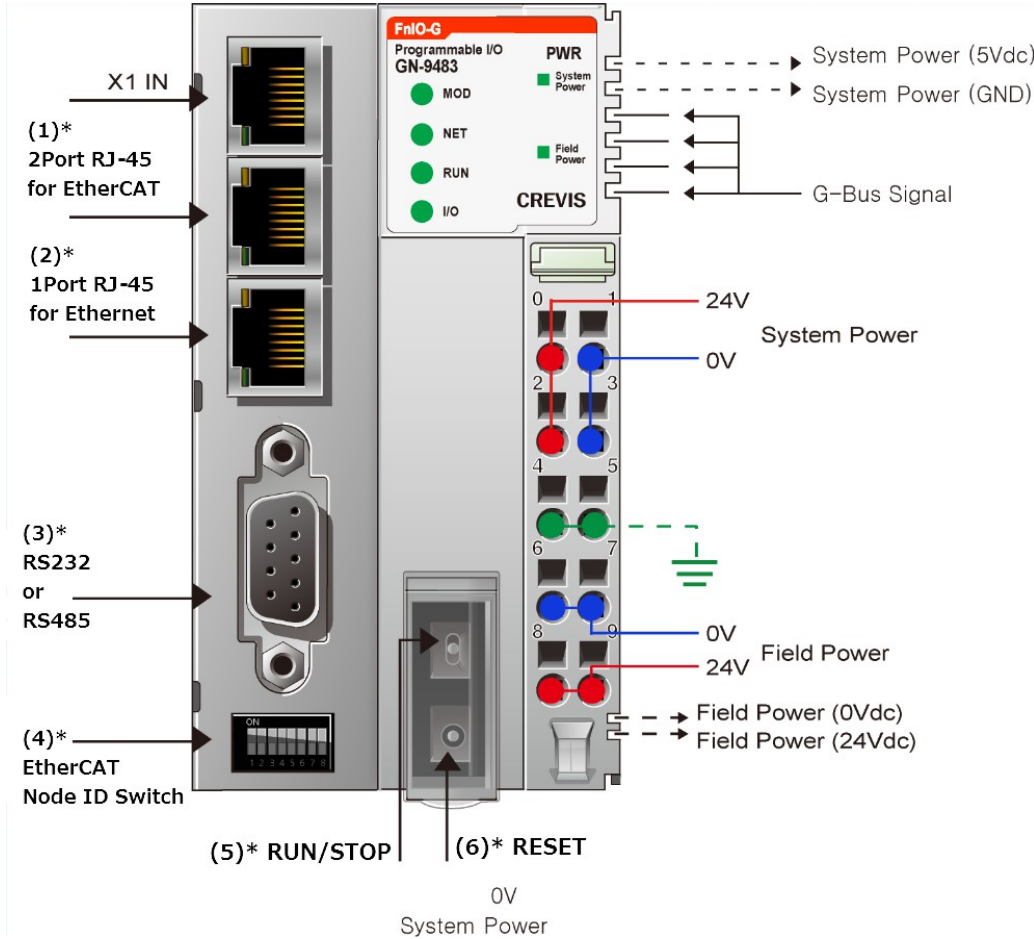

Pin No.	Signal Description	Signal Description	Pin No.
0	System Power, 24V	System Power, Ground	1
2	System Power, 24V	System Power, Ground	3
4	F.G	F.G	5
6	Field Power, Ground	Field Power 0V, Ground	7
8	Field Power, 24V	Field Power, 24V	9

**\* Warning:** The system power must not be connected with field power. Use separate voltage supplies.

## 2.4. GN-9481/9482/9483 LED Indicator

### 2.4.1. LED Indicator

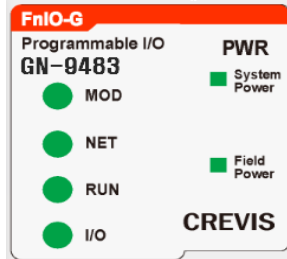

LED No.	LED Function / Description	LED Color
MOD	Module Status	Green/Red
NET	Network Status	Green/Red
RUN	PLC Run/Stop Status	Green/Red
IOS	Expansion Module Status	Green/Red
Field Power	Field Power Enable	Green
System Power	System Power Enable	Green

### 2.4.2. MOD (Module Status LED)

Status	LED is	To indicate
Not Powered	OFF	Power is not supplied to the unit.
Normal, Operational	Green	The unit is operating in normal condition.
Device in Standby	Blinking Green	The EEPROM parameter is not initialized yet. Serial Number is zero value (0x00000000)
IAP Mode	Toggling Green & Red	IAP Mode : Available for firmware download using FireFox.
Unrecoverable Fault	Red	The unit has occurred unrecoverable fault in self-testing. - Firmware fault

\* The IP Address to access IAP web-server during IAP Mode: 192.168.100.10 (Recommended to use FireFox)

### 2.4.3. NET (Network Status LED)

Status	LED is	To indicate	
Initialize	OFF	Non-Operating or Initialize	
Operate	Green	Operating	
	Blinking Green	Pre-Operating	LED ON : 200ms / LED OFF : 200ms
		Safe-Operating	LED ON : 200ms / LED OFF : 1s
Error	Red	Network Error	
Diagnorstic	Blinking Red	Diagnostic Mode	

\*Blinking Green MOD & NET LED: Bootp/DHCP is requesting for new IP address.

(You can change the IP setting mode. Please refer to specification.)

### 2.4.4. RUN (PLC Run/Stop Status LED)

Status	LED is	To indicate
Not programmed	OFF	The unit is not programmed or not powered.
Run	Green	PLC Run
Stop	Blinking Green	PLC Stop
Program Error	Blinking Red	PLC program error

# Specification

## 2.4.5. IOS LED (Expansion Module Status LED)

Status	LED is	To indicate
Not Powered No Expansion Module	OFF	Device has no expansion module or may not be powered.
On-line, Do not Exchanging I/O	Blinking Green	I/O Communication is normal but does not exchanging I/O data. (Passed the expansion module configuration)
Connection, Run Exchanging I/O	Green	Exchanging I/O data.
Connection Fault during Exchanging I/O	Blinking Red	One or more expansion module occurred in fault state. <ul style="list-style-type: none"> <li>- Changed expansion module configuration.</li> <li>- Communication failure.</li> <li>- Overflowed Input/Output size.</li> </ul>
Expansion Configuration Failed	Red	Failed to initialize expansion module. <ul style="list-style-type: none"> <li>- Detect invalid expansion module ID.</li> <li>- Too many expansion module.</li> <li>- Initial protocol failure.</li> <li>- Mismatch vendor code between adapter and expansion module.</li> </ul>

## 2.4.6. Field Power LED (Field Power Status LED)

Status	LED is	To indicate
Not supplied field power	OFF	Not supplied 24Vdc field power.
Supplied field power	Green	Supplied 24Vdc field power.



## 2.5. GN-9481/9482/9483 Electrical Interface

### 2.5.1. RJ-45 Socket (1pcs)

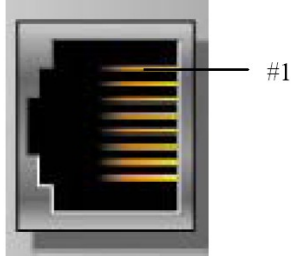

Shielded RJ-45 Socket

RJ-45	Signal Name	Description
1	TD+	Transmit +
2	TD-	Transmit -
3	RD+	Receive +
4	-	
5	-	
6	RD-	Receive -
7	-	
8	-	
Case	Shield	

### 2.5.2. RS-232/RS-485 Port for MODBUS/RTU, Touch Pannel or IOGuide

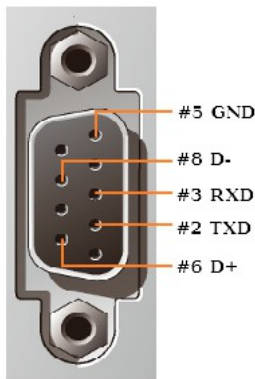

D-Sub 9Pin		
Pin#	Signal Name	Description
1	-	
2	TXD	RS232 TXD
3	RXD	RS232 RXD
4	-	
5	GND	RS232 GND
6	D+	RS485 D+
7	-	
8	D-	RS485 D-
9	-	

### 2.5.3. Toggle Switch and Push Botton

Toggle Switch Status	Module is	Description
UP	RUN	PLC Run
DOWN	STOP	PLC Stop
Push Botton	Module is	Description
Push and detach	Reset	PLC Reset and Stop
Push for 5sec and Power Reset	PLC Reset	Erase PLC user program and Retain memory
Push for 20sec and Power Reset	Factory Reset	Erase PLC user program and PLC parameter reset
Push hold and Power Reset	IAP mode	Firmware download via FireFox.

## 2.6. GN-9481/9482/9483 EtherCAT Interface

### 2.6.1. RJ-45 Socket (2pcs)

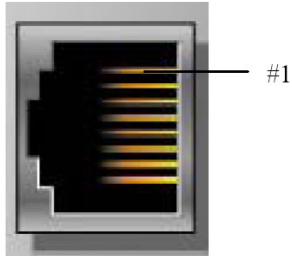

Shielded RJ-45 Socket

RJ-45	Signal Name	Description
1	TD+	Transmit +
2	TD-	Transmit -
3	RD+	Receive +
4	-	
5	-	
6	RD-	Receive -
7	-	
8	-	
Case	Shield	

### 2.6.2. EtherCAT Node Setting Switch

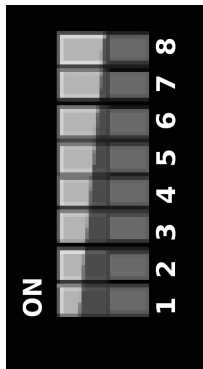

DIP Pole #	Description
1	Identification Value DIP bit#0
2	Identification Value DIP bit#1
3	Identification Value DIP bit#2
4	Identification Value DIP bit#3
5	Identification Value DIP bit#4
6	Identification Value DIP bit#5
7	Identification Value DIP bit#6
8	Identification Value DIP bit#7

## 2.7. GN-9481/9482/9483 Web-Server

\* Web-Server Address : <http://IP/setup.htm> (http://192.168.100.40/setup.htm)

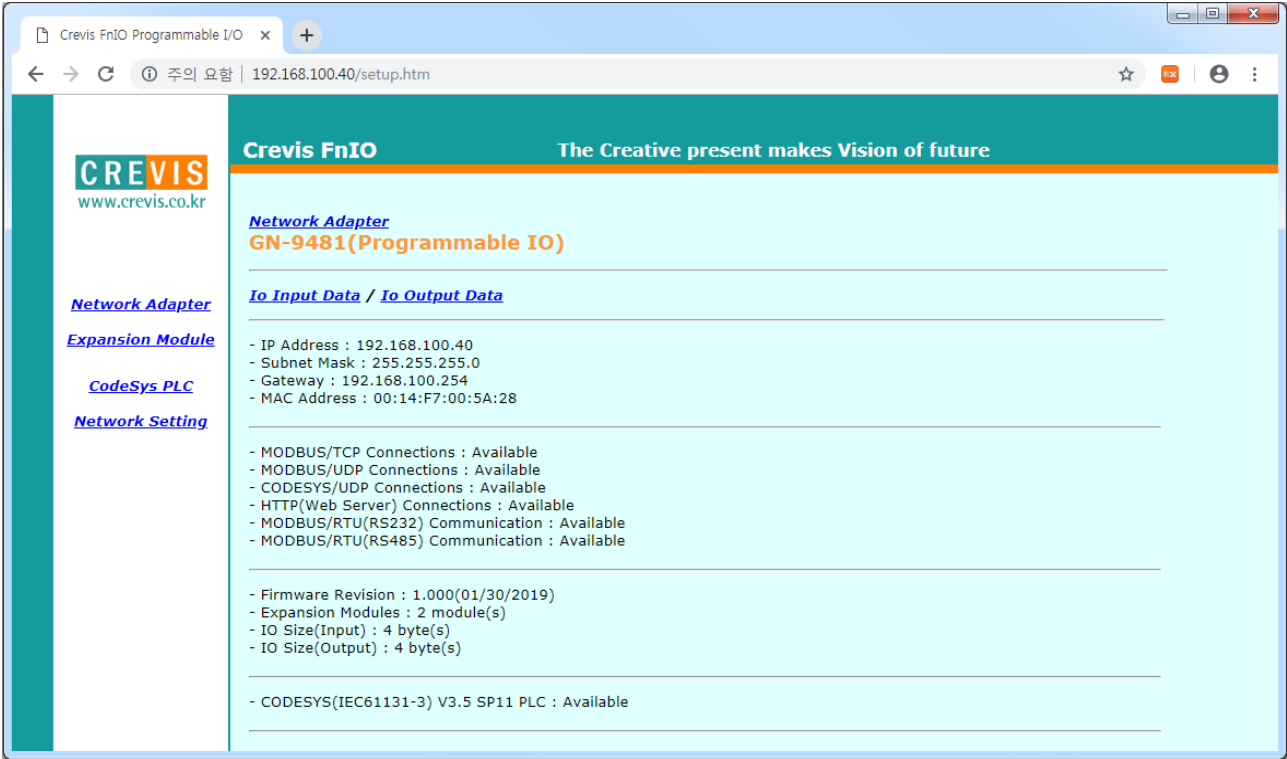

- Showing the expansion modules that attached to PIO

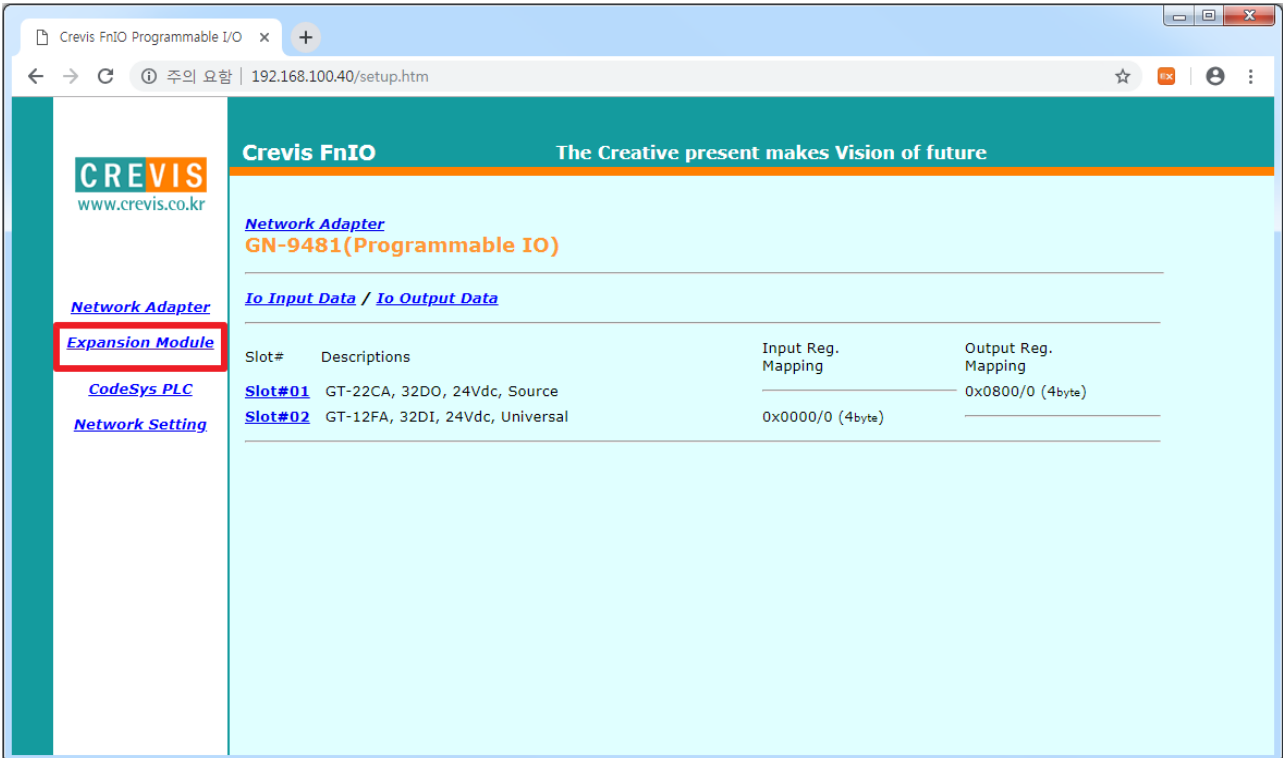

# Specification

- Showing CoDeSys PLC programming information and RTC time setting. RTC time can be changeable in this page.

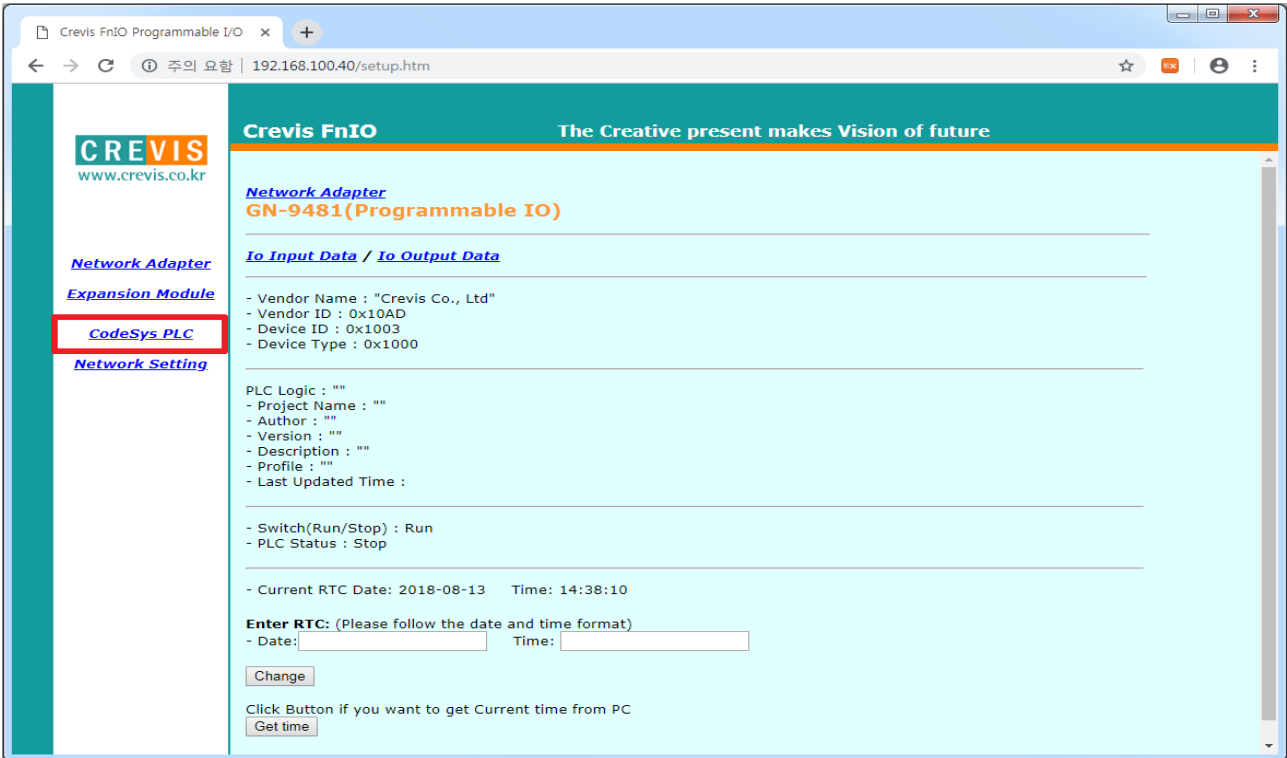

- Network setting can be changeable in this page.

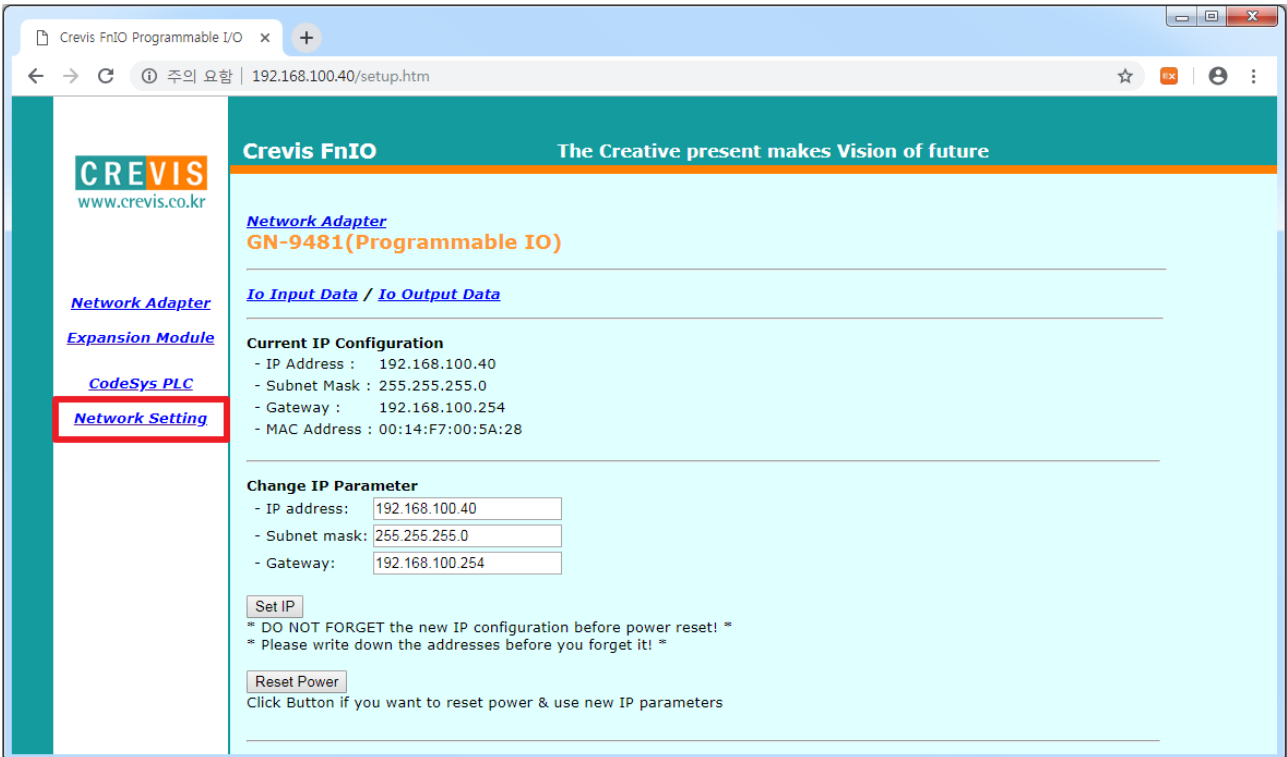

## 3. EtherCAT INTERFACE

### 3.1. EtherCAT Basics

The EtherCAT protocol uses an officially assigned EtherType inside the Ethernet Frame. The use of this EtherType allows transport of control data directly within the Ethernet frame without redefining the standard Ethernet frame. The frame may consist of several sub-telegrams, each serving a particular memory area of the logical process images that can be up to 4 gigabytes in size. Addressing of the Ethernet terminals can be in any order because the data sequence is independent of the physical order. Broadcast, Multi-cast and communication between slaves are possible

### 3.2. EtherCAT State Machine

The state of the EtherCAT slave is controlled via the EtherCAT State Machine (ESM). Depending upon the state, different functions are accessible or executable in the EtherCAT slave. Specific commands must be sent by the EtherCAT master to the device in each state, particularly during the boot up of the slave.

A distinction is made between the following states:

- Init
- Pre-Operational
- Safe-Operational and
- Operational
- Bootstrap

The regular state of each EtherCAT slave after bootup is the OP state.

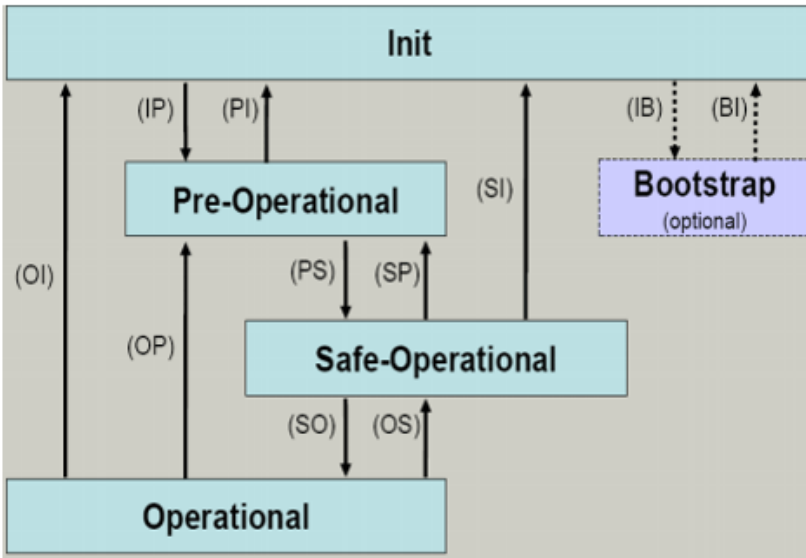

#### Init

After switch-on the EtherCAT slave in the Init state. No mailbox or process data communication is possible.

The EtherCAT master initializes sync manager channels 0 and 1 for mailbox communication.

---

## Pre-Operational (Pre-Op)

During the transition between Init and Pre-Op the EtherCAT slave checks whether the mailbox was initialized correctly.

In Pre-Op state mailbox communication is possible, but not process data communication. The EtherCAT master initializes the sync manager channels for process data (from sync manager channel 2), the FMMU channels and, if the slave supports configurable mapping, PDO mapping or the sync manager PDO assignment. In this state the settings for the process data transfer and perhaps terminal-specific parameters that may differ from the default settings are also transferred.

## Safe-Operational (Safe-Op)

During transition between Pre-Op and Safe-Op the EtherCAT slave checks whether the sync manager channels for process data communication and, if required, the distributed clocks settings are correct. Before it acknowledges the change of state, the EtherCAT slave copies current input data into the associated DP-RAM areas of the EtherCAT slave controller (ECSC).

In Safe-Op state mailbox and process data communication is possible, although the slave keeps its outputs in a safe state, while the input data are updated cyclically.

## Operational (Op)

Before the EtherCAT master switches the EtherCAT slave from Safe-Op to Op it must transfer valid output data.

In the Op state the slave copies the output data of the masters to its outputs. Process data and mailbox communication is possible.

## Bootstrap

In the Boot state the slave firmware can be updated. The Boot state can only be reached via the Init state.

In the Boot state mailbox communication via the file access over EtherCAT (FoE) protocol is possible, but no other mailbox communication and no process data communication.

## 3.3. CoE Interface

### 3.3.1. parameter management in the EtherCAT system

The CiA organization (CAN in Automation) pursues among other things the goal of creating order and exchange ability between devices of the same type by the standardization of device descriptions. For this purpose so-called profiles are defined, which conclusively describe the changeable and unchangeable parameters of a device. Such a parameter encompasses at least the following characteristics:

- ✓ Index number – for the unambiguous identification of all parameters. The index number is divided into a main index and a subindex in order to mark and arrange associated parameters.
  - Main index
  - Subindex, offset by a colon ‘:’
- ✓ Official name – in the form of an understandable, self-descriptive text
- ✓ Specification of changeability, e.g. whether it can only be read or can also be written
- ✓ A value – depending upon the parameter the value can be a text, a number or another parameter index.

# Specification

## Index Range

The relevant ranges for EtherCAT fieldbus users are:

**x1000** : This is where fixed identity information for the device is stored, including name, manufacturer, serial number etc., plus information about the current and available process data configurations.

**x8000** : This is where the operational and functional parameters for all channels are stored, such as filter settings or output frequency.

Other important ranges are:

**x4000** : In some EtherCAT devices the channel parameters are stored here (as an alternative to the x8000 range).

**x6000** : Input PDOs ("input" from the perspective of the EtherCAT master)

**x7000** : Output PDOs ("output" from the perspective of the EtherCAT master)

## 3.3.2. Communication Objects

Index	Sub-index	Name	Flags	Default value
1000		Device type	RO	0x00001389
1001		Gbus Status	RO	Normal Operation : 0x00 **
1002		Master Fault Aaction	RW	0x00
1008		Device name	RO	GN-948x(Crevis)
1009		Hardware version	RO	GN-948x.v1
100A		Software version	RO	1.000
1018		Identity	RO	0x05
	01	Vendor ID (Crevis: 029D)	RO	0x0000029D
	00	Moduler Type Product code	RO	0x474E948x
		Non-Moduler Type Product code	RO	0x474F948x
	03	Revision	RO	0x0001000
	04*	Serial number	RO	0xFFFFFFFF
05	Release date	RO	0x20160823	
10F1		Error Settings	RO	0x02
	01	Local Error Reaction	RO	0x00000000
	02	Sync Error Counter Limit	RO	0x00000004
1601*		Slot#x, GT--xxxx,RXPDO	RO	0xnn
	01	SubIndex 001	RO	0x7010:01, 8
	...	...	...	...
	nn	SubIndex nnn	RO	0x7010:nn, 8
1A01*		Slot#x, GT-xxxx, TXPDO	RO	0xnn
	01	SubIndex 001	RO	0x6010:01, 8
	...	...	...	...
	nn	SubIndex nnn	RO	0x6010:nn, 8
		Sync manager type	RO	0x04

# Specification

1C00	01	SubIndex 001	RO	0x01
	02	SubIndex 002	RO	0x02
	03	SubIndex 003	RO	0x03
	04	SubIndex 004	RO	0x04
1C12	RxPDO assign		RO	0x01
	01	SubIndex 001	RO	0x1601
1C13	TxPDO assign		RO	0x02
	01	SubIndex 001	RO	0x1A01
	02	SubIndex 002	RO	0x1A02
7010*	GT-xxxx		RO	0xnn
	01	Byte#0	RW P	0x00
	...	...	...	...
	nn	Byte#nnn	RW P	0x00
8000	GN-948x(Parameter)		RO	
	01	Byte#0	RW	
	02	Byte#1	RW	
	03	Byte#2	RW	
	04	Byte#3	RW	
8nn0*	GT-xxxx(Parameter)		RO	
	01	Byte#0	RW	
	...	...	...	...
	nn	Byte#nnn	RW	
F000	Module device profile		RO	
	01	Module index distance	RO	
	02	Maximum number of modules	RO	
F010*	Module List		RO	
	01	Subindex 001 (GN-948x)	RO	0x0000948x
	...	...	...	...
	63	Subindex 063	RO	0x0000xxxx
F050	Detected Module Ident List		RO	
	01...	SubIndex 001	RO	

\*This value can be changed depending on the configuration of expansion modules

\*\* Gbus Status

- Normal Operation : 0x00
- Communication Fault : 0x02
- Configuration Failed : 0x03
- No Expansion Module : 0x04
- Vendor Error : 0x07
- Not expected slot : 0x08
- CRC Error : 0x09



## 4. MODBUS/RTU INTERFACE

### 4.1. Supported MODBUS Function Codes

Function Code	Function	Description
1(0x01)	Read Coils	Read output bit
2(0x02)	Read Discrete Inputs	Read input bit
3(0x03)	Read Holding Registers	Read output word
4(0x04)	Read Input Registers	Read input word
5(0x05)	Write Single Coil	Write one bit output
6(0x06)	Write Single Register	Write one word output
8(0x08)	Diagnostics	Read diagnostic register
15(0x0F)	Write Multiple Coils	Write a number of output bits
16(0x10)	Write Multiple registers	Write a number of output words
23(0x17)	Read/Write Multiple registers	Read a number of input words /Write a number of output words

- Refer to MODBUS APPLICATION PROTOCOL SPECIFICATION V1.1a

#### 4.1.1. 1 (0x01) Read Coils

This function code is used to read from 1 to 2000 contiguous status of coils in a remote device. The Request PDU specifies the starting address, i.e. the address of the first coil specified, and the number of coils. In the PDU Coils are addressed starting at zero. Therefore coils numbered 1-16 are addressed as 0-15. The coils in the response message are packed as one coil per bit of the data field. Status is indicated as 1= ON and 0= OFF.

- **Request**

Field name	Example
Function Code	0x01
Starting Address Hi	0x10
Starting Address Lo	0x00
Quantity of Outputs Hi	0x00
Quantity of Outputs Lo	0x0A

- **Response**

Field name	Example
Function Code	0x01
Byte Count	0x02
Output Status	0x55
Output Status	0x02

- In case of address 0x1015~0x1000 output bit value: 10101010\_01010101.

#### 4.1.2. 2 (0x02) Read Discrete Inputs

This function code is used to read from 1 to 2000 contiguous status of discrete inputs in a remote device. The Request PDU specifies the starting address, i.e. the address of the first input specified, and the number of inputs. In the PDU Discrete Inputs are addressed starting at zero. Therefore Discrete inputs numbered 1-16 are addressed as 0-15.

The discrete inputs in the response message are packed as one input per bit of the data field.

Status is indicated as 1= ON; 0= OFF.

- **Request**

Field name	Example
Function Code	0x02
Starting Address Hi	0x00
Starting Address Lo	0x00
Quantity of Inputs Hi	0x00
Quantity of Inputs Lo	0x0A

- **Response**

Field name	Example
Function Code	0x02
Byte Count	0x02
Input Status	0x80
Input Status	0x00

- In case of address 0x0015~0x0000 input bit value: 00000000\_10000000.

#### 4.1.3. 3 (0x03) Read Holding Resgisters

This function code is used to read the contents of a contiguous block of holding registers in a remote device. The Request PDU specifies the starting register address and the number of registers.

The register data in the response message are packed as two bytes per register, with the binary contents right justified within each byte. For each register, the first byte contains the high order bits and the second contains the low order bits.

- **Request**

Field name	Example
Function Code	0x03
Starting Address Hi	0x08
Starting Address Lo	0x00
Quantity of Register Hi	0x00
Quantity of Register Lo	0x02

- **Response**

Field name	Example
Function Code	0x03
Byte Count	0x04
Output Register#0 Hi	0x11
Output Register#0 Lo	0x22
Output Register#1 Hi	0x33
Output Register#1 Lo	0x44

- In case of address 0x0800, 0x0801 output register value: 0x1122, 0x3344.

#### 4.1.4. 4 (0x04) Read Input Registers

This function code is used to read from 1 to approx. 125 contiguous input registers in a remote device. The Request PDU specifies the starting register address and the number of registers. The register data in the response message are packed as two bytes per register, with the binary contents right justified within each byte. For each register, the first byte contains the high order bits and the second contains the low order bits.

- **Request**

Field name	Example
Function Code	0x04
Starting Address Hi	0x00
Starting Address Lo	0x00
Quantity of Register Hi	0x00
Quantity of Register Lo	0x02

- **Response**

Field name	Example
Function Code	0x03
Byte Count	0x04
Input Register#0 Hi	0x00
Input Register#0 Lo	0x80
Input Register#1 Hi	0x00
Input Register#1 Lo	0x00

- In case of address 0x0000, 0x0001 input register value: 0x0080, 0x0000.

#### 4.1.5. 5 (0x05) Write Single Coil

This function code is used to write a single output to either ON or OFF in a remote device. The requested ON/OFF state is specified by a constant in the request data field. A value of FF 00 hex requests the output to be ON. A value of 00 00 requests it to be OFF. All other values are illegal and will not affect the output.

- **Request**

Field name	Example
Function Code	0x05
Output Address Hi	0x10
Output Address Lo	0x01
Output Value Hi	0xFF
Output Value Lo	0x00

- **Response**

Field name	Example
Function Code	0x05
Output Address Hi	0x10
Output Address Lo	0x01
Output Value Hi	0xFF
Output Value Lo	0x00

- Output bit of address 0x1001 turns ON.

#### 4.1.6. 6 (0x06) Write Single Register

This function code is used to write a single holding register in a remote device. Therefore register numbered 1 is addressed as 0. The normal response is an echo of the request, returned after the register contents have been written.

- **Request**

Field name	Example
Function Code	0x06
Register Address Hi	0x08
Register Address Lo	0x00
Register Value Hi	0x11
Register Value Lo	0x22

- **Response**

Field name	Example
Function Code	0x06
Register Address Hi	0x08
Register Address Lo	0x00
Register Value Hi	0x11
Register Value Lo	0x22

- In case of address 0x0800 output register value: 0x0000 changes to 0x1122.

#### 4.1.7. 8 (0x08) Diagnostics

MODBUS function code 08 provides a series of tests for checking the communication system between a client ( Master) device and a server ( Slave), or for checking various internal error conditions within a server.

The function uses a two-byte sub-function code field in the query to define the type of test to be performed. The server echoes both the function code and sub-function code in a normal response. Some of the diagnostics cause data to be returned from the remote device in the data field of a normal response.

- **Request**

Field name	Example
Function Code	0x08
Sub-Function Hi	0x00
Sub-Function Lo	0x00
Data Hi	0x11
Data Lo	0x22

- **Response**

Field name	Example
Function Code	0x08
Sub-Function Hi	0x00
Sub-Function Lo	0x00
Data Hi	0x11
Data Lo	0x22

**Sub-function 0x0000(0) Return Query Data**

The data passed in the request data field is to be returned (looped back) in the response.

The entire response message should be identical to the request.

Sub-function	Data Field (Request)	Data Field (Response)	Description
0x0000(0)	Any	Echo Request Data	

**Sub-function 0x0001(1) Restart Communications Option**

The remote device could be initialized and restarted, and all of its communications event counters are cleared.

Especially, data field 0x55AA make the remote device to restart with factory default setup of EEPROM.

Sub-function	Data Field (Request)	Data Field (Response)	Description
0x0001(1)	0x0000 or 0xFF00	Echo Request Data	Reset
0x0001(1)	0x55AA	Echo Request Data	Reset with Default Setting <sup>1)</sup>
0x0001(1)	0x55AA+0xAB7B+Sumcheck <sup>4)</sup>	Echo Request Data	Reset with Factory default <sup>2)</sup>
0x0001(1)	0x55AA+0xAA55+Sumcheck <sup>4)</sup>	Echo Request Data	Reset with Factory default <sup>3)</sup>

1),2),3) All expansion slot configuration parameters are cleared.

2),3) IP Address, Subnet Mask Address, Gateway Address, RS232/485 setting, and Bootp/DHCP mode will be the factory defaults value.

3) Mac Address will be the factory default value.

4) Refer to 3.2.2 for Sumcheck (0x1006)

**Sub-function 0x000A(10) Clear Counters and Diagnostic Register**

The goal is to clear all counters and the diagnostic register. Counters are also cleared upon power-up.

Sub-function	Data Field (Request)	Data Field (Response)	Description
0x000A(10)	0x0000	Echo Request Data	

**Sub-function 0x000B(11) Return Bus Message Count**

The response data field returns the quantity of messages that the remote device has detected on the communications system since its last restart, clear counters operation, or power-up.

Sub-function	Data Field (Request)	Data Field (Response)	Description
0x000B(11)	0x0000	Total Message Count	

# Specification

## Sub-function 0x000D(13) Return Bus Exception Error Count

The response data field returns the quantity of MODBUS exception responses returned by the remote device since its last restart, clear counters operation, or power-up.

Exception responses are described and listed in section 3.2.11.

Sub-function	Data Field (Request)	Data Field (Response)	Description
0x000D(13)	0x0000	Exception Error Count	

## Sub-function 0x000E(14) Return Slave Message Count

The response data field returns the quantity of messages addressed to the remote device, or broadcast, that the remote device has processed since its last restart, clear counters operation, or power-up.

Sub-function	Data Field (Request)	Data Field (Response)	Description
0x000E(14)	0x0000	Slave Message Count	

## Sub-function 0x000F(15) Return Slave No Response Count

The response data field returns the quantity of messages addressed to the remote device for which it has returned no response (neither a normal response nor an exception response), since its last restart, clear counters operation, or power-up.

Sub-function	Data Field (Request)	Data Field (Response)	Description
0x000F(15)	0x0000	Slave No Response Count	

## Sub-function 0x0064(100) Return Slave ModBus, Expansion Status

The response data field returns the status of ModBus and expansion addressed to the remote device.

This status values are identical with status 1word of input process image.

Sub-function	Data Field (Request)	Data Field (Response)	Description
0x0064(100)	0x0000	ModBus, G-Bus Status	Same as status 1word

#### 4.1.8. 15 (0x0F) Write Multiple Coils

This function code is used to force each coil in a sequence of coils to either ON or OFF in a remote device. The Request PDU specifies the coil references to be forced. Coils are addressed starting at zero. A logical '1' in a bit position of the field requests the corresponding output to be ON. A logical '0' requests it to be OFF.

The normal response returns the function code, starting address, and quantity of coils forced.

- **Request**

Field name	Example
Function Code	0x0F
Starting Address Hi	0x10
Starting Address Lo	0x00
Quantity of Outputs Hi	0x00
Quantity of Outputs Lo	0x0A
Byte Count	0x02
Output Value#0	0x55
Output Value#1	0x01

- **Response**

Field name	Example
Function Code	0x0F
Starting Address Hi	0x10
Starting Address Lo	0x00
Quantity of Outputs Hi	0x00
Quantity of Outputs Lo	0x0A

- In case of address 0x1015~0x1000 output bit value: 00000000\_00000000 changes to 00000001\_01010101.

#### 4.1.9. 16 (0x10) Write Multiple Resgisters

This function code is used to write a block of contiguous registers (1 to approx. 120 registers) in a remote device.

The requested written values are specified in the request data field. Data is packed as two bytes per register.

The normal response returns the function code, starting address, and quantity of registers written.

- **Request**

Field name	Example
Function Code	0x0F
Starting Address Hi	0x10
Starting Address Lo	0x08
Quantity of Registers Hi	0x00
Quantity of Registers Lo	0x02
Byte Count	0x04
Register Value#0 Hi	0x11
Register Value#0 Lo	0x22
Register Value#1 Hi	0x33
Register Value#1 Lo	0x44

- **Response**

Field name	Example
Function Code	0x0F
Starting Address Hi	0x10
Starting Address Lo	0x08
Quantity of Registers Hi	0x00
Quantity of Registers Lo	0x02

- In case of address 0x0800, 0x0801 output register value: 0x0000, 0x0000 changes to 0x1122, 0x3344.

#### 4.1.10. 23 (0x17) Read/Write Multiple Resgisters

This function code performs a combination of one read operation and one write operation in a single MODBUS transaction. The write operation is performed before the read. The request specifies the starting address and number of holding registers to be read as well as the starting address, number of holding registers, and the data to be written. The byte count specifies the number of bytes to follow in the write data field.

The normal response contains the data from the group of registers that were read. The byte count field specifies the quantity of bytes to follow in the read data field.

- **Request**

Field name	Example
Function Code	0x17
Read Starting Address Hi	0x08
Read Starting Address Lo	0x00
Quantity of Read Hi	0x00
Quantity of Read Lo	0x02
Write Starting Address Hi	0x08
Write Starting Address Lo	0x00
Quantity of Write Hi	0x00
Quantity of Write Lo	0x02
Byte Count	0x04
Write Reg. Value#0 Hi	0x11
Write Reg. Value#0 Lo	0x22
Write Reg. Value#1 Hi	0x33
Write Reg. Value#1 Lo	0x44

- **Response**

Field name	Example
Function Code	0x17
Byte Count	0x04
Read Reg. Value#0 Hi	0x11
Read Reg. Value#0 Lo	0x22
Read Reg. Value#1 Hi	0x33
Read Reg. Value#1 Lo	0x44

- In case of address 0x0800, 0x0801 output register value: 0x0000, 0x0000 changes to 0x1122, 0x3344.



#### 4.1.11. Error Response

In an exception response, the server sets the MSB of the function code to 1. This makes the function code value in an exception response exactly 80 hexadecimal higher than the value would be for a normal response.

- **Exception Response Example**

Field name	Example
Function Code	0x81
Exception Code	0x02

- **Exception Codes**

Exception Code	Name	Description
01	Illegal Function	The function code received in the query is not an allowable action for the server (or slave).
02	Illegal Data Address	The data address received in the query is not an allowable address for the server (or slave).
03	Illegal Data Value	A value contained in the query data field is not an allowable value for server (or slave).
04	Slave Device Failure	An unrecoverable error occurred while the server (or slave) was attempting to perform the requested action.
06	Slave Device Busy	Specialized use in conjunction with programming commands. The server (or slave) is engaged in processing a long-duration program command. The client (or master) should retransmit the message later when the server (or slave) is free.

## 4.2. MODBUS Special Register Map

The special register map can be accessed by function code 3, 4, 6 and 16. Also the special register map must be accessed by read/write of every each address (one address).

### 4.2.1. Adapter Resgister Mapping

Address	IEC Address	Contents	Remarks
0x0000~0x07FF	%IW0~%IW2047	2048 words Input and Internal memory (Area is write-protected)	
0x0800~0x0FFF	%QW0~%QW2047	2048 words Output and Internal memory (Area is write-enabled)	
0x1000~0x1FFF	-	Special Function Register (PIO Information)	
0x2000~0x2FFF	-	Special Function Register (Slot Information)	
0x4000~0x5FFF	%MW0~%MW8191	8192 words Internal memory (Area is write-enabled)	

### 4.2.2. Adapter Identification Special Resgister (0x1000, 4096)

Address	Access	Type, Size	Description
0x1000(4096)	Read	1word	Vendor ID = 0x02E5(741), Crevis. Co., Ltd.
0x1001(4097)	Read	1word	Device type = 0x000C, Network Adapter
0x1002(4098)	Read	1word	Product Code = 0x9130(GN-9481) / 0x9140(GN-9482) / 0x9150(GN-9483)
0x1003(4099)	Read	1word	Firmware revision, if 0x0101, revision 1.001
0x1005(4101)	Read	String upto 34bytes	Product name string First 1word is length of valid character string Example) response as following "00 1C 47 4E 2D 39 34 38 31 28 50 49 4F 29 00 00 00 00 00 00 00 00 00 00 00 00 00 00 00 00 00 00" Valid character size = 0x0017 =29 characters "GN-9481(PIO)"
0x1006(4102)	Read	1word	Sum check of EEPROM
0x1010(4112)	Read	2words	Firmware release date
0x101E(4126)	Read	15words	Composite Id of following address 0xA8C0(Lo_IP Addr),0x3264(Hi_IP Addr),0xFFFF(Lo_NetMask), 0x00FF(Hi_NetMask),0xA8C0(GateWay),0xFE64(GateWay), 0x1400(MacAddr),0x00F7(MacAddr),0xBA83(MacAddr), 0x02E5(VendorCode),0x000C(DeviceType),0x9120(ProductCode), 0x0200(FW_Rev),0x0420(FW_ReleasData),0x2018(FW_ReleasYear)

- String Type consists of valid string length (first 1word) and array of characters

**4.2.3. Adapter Information Special Register (0x1100, 4352)**

Address	Access	Type, Size	Description
0x1102(4354)	Read	1word	Start address of input image word register. =0x0000
0x1103(4355)	Read	1word	Start address of output image word register. =0x0800
0x1104(4356)	Read	1word	Size of input image word register.
0x1105(4357)	Read	1word	Size of output image word register.
0x1106(4358)	Read	1word	Start address of input image bit. = 0x0000
0x1107(4359)	Read	1word	Start address of output image bit. =0x1000
0x1108(4360)	Read	1word	Size of input image bit.
0x1109(4361)	Read	1word	Size of output image bit.
0x110D(4365)	Read	1word	Field Power On/OFF, Run/Stop Switch, Reset Switch *Field Power On : 0x0010 / Field Power Off : 0x8000 *Stop : 0x0000 / Run : 0x0001 / Reset Switch : 0x0002 ex) 0x0013 : Field Power On + Run + Reset Switch ON
0x110E(4366)	Read	upto 63words	Expansion slot's GT-number If the PIO is connected with GT-222F and GT-123F, then 0x222F 0x123F
0x1110(4368)	Read	1word	Number of expansion slot.
0x1113(4371)	Read	upto 63words	Expansion slot Module Id. Refer to Appendix A.1 Product List. First 1word is adapter's module id.
0x111E(4382)	Read	1word	Reserved. Adapter IO identification vendor code.

# Specification

## 4.2.4. Adapter Setting Special Register (0x1600, 5632)

Address	Access	Type, Size	Description
0x1600(5632)	Read	2words	IP Address. (ex : A8C0 6464 = 192.168.100.100)
0x1602(5634)	Read	2words	Subnet Mask. (ex : FFFF 0000 = 255.255.0.0)
0x1604(5636)	Read	2words	Gate way. (ex : A8C0 0100 = 192.168.0.1)
0x1606(5638)	Read/Write	1word	RS-232C Baudrate. (2400bps~115200bps) - 0 : 115200 (default) - 1 : 2400 - 2 : 4800 - 3 : 9600 - 4 : 19200 - 5 : 38400 - 6 : 57600 - 7 : 115200
0x1607(5639)	Read/Write	1word	*RS-232C Setting. - 1 nibble : Data bit(0 : 8bit(default), 1 : 9bit) - 2 nibble : Stop bit(0 : 1bit(default), 1 : 2bit) - 3 nibble : Parity bit(0 : none(default), 1: odd, 2 : even) - 4 nibble : Reserve
0x1608(5640)	Read/Write	1word	RS-485 Baudrate. (2400bps~115200bps) - 0 : 115200 (default) - 1 : 2400 - 2 : 4800 - 3 : 9600 - 4 : 19200 - 5 : 38400 - 6 : 57600 - 7 : 115200
0x1609(5641)	Read/Write	1word	RS-485 Setting. - 1 nibble : Data bit(0 : 8bit(default), 1 : 9bit) - 2 nibble : Stop bit(0 : 1bit(default), 1 : 2bit) - 3 nibble : Parity bit(0 : none(default), 1: odd, 2 : even) - 4 nibble : Reserve
0x160A(5642)	Read/Write	1word	**Modbus Station. - High 1byte : Station No. of RS-232C (default : 1) - Low 1byte : Station No. of RS-485 (default : 1)
0x160B(5643)	Read/Write	1word	IP Setting Method. - BootP/DHCP disable: 0x0000 - BootP : 0x8000 (default) - DHCP : 0x8001
0x1610(5648)	Read	3words	Mac Address (ex : 1400 00F7 0101 = 00.14.F7.00.01.01)
0x1614(5652)*	Read	1word	Serial connection Method - 0x0000 : Crevis Modbus/RTU (default) - 0x8000 : RS232 Enable for CoDeSys Function block / RTU Master - 0x8001 : RS485 Enable for CoDeSys Function block / RTU Master - 0x8002 : RS232/RS485 Enable at the same time for CoDeSys Function block / RTU Master
0x1616(5654)	Read/Write	1word	EtherCAT Type Setting (0: Moduler Type / 1: Non-Moduler Type)
0x1617(5655)	Read	1word	Non-Moduler Type Input Size
0x1618(5356)	Read	1word	Non-Moduler Output Size
0x1619(5357)	Read	1word	EtherCAT ID (0 ~ 255) / EtherCAT Node Setting Switch Data
0x1620(5664)	Read/Write	4words	RTC - 1 word : 00ss (ss : sec) - 2 word : hhmm (hh : hour, mm : min) - 3 word : mmdd (mm : month, dd : day) - 4 word : yyyy (yyyy : year) (ex : 0010 0F28 0317 07E0 = 2016 - 03.23 - 15:40 - 16)

# Specification

**\*RS-232C/485 Setting :** This description for 0x1607/0x1609 register with bit.

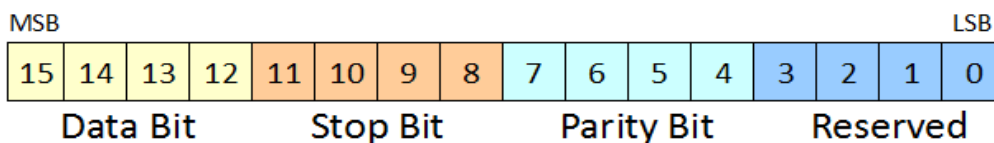

**\*\*Modbus Station :** This description for 0x160A register with bit.

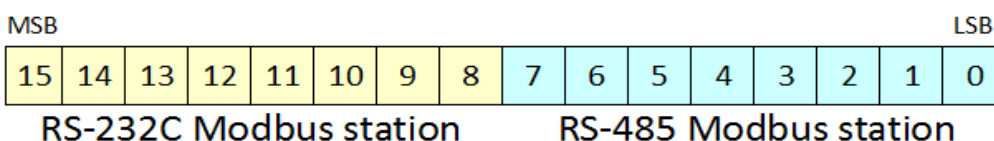

## 4.2.5. Expansion Slot Information Special Resister (0x2000, 8192)

Each expansion slot has 0x40(64) address offset and same information structure.

Slot#1	0x2000(8192)~0x201F(8223)	Slot#2	0x2020(8224)~0x203F(8255)
Slot#3	0x2040(8256)~0x205F(8287)	Slot#4	0x2060(8288)~0x207F(8319)
Slot#5	0x2080(8320)~0x209F(8351)	Slot#6	0x20A0(8352)~0x20BF(8383)
Slot#7	0x20C0(8384)~0x20DF(8415)	Slot#8	0x20E0(8416)~0x20FF(8447)
Slot#9	0x2100(8448)~0x211F(8479)	Slot#10	0x2120(8480)~0x213F(8511)
Slot#11	0x2140(8512)~0x215F(8543)	Slot#12	0x2160(8544)~0x217F(8575)
Slot#13	0x2180(8576)~0x219F(8607)	Slot#14	0x21A0(8608)~0x21BF(8639)
Slot#15	0x21C0(8640)~0x21DF(8671)	Slot#16	0x21E0(8672)~0x21FF(8703)
Slot#17	0x2200(8704)~0x221F(8735)	Slot#18	0x2220(8736)~0x223F(8767)
Slot#19	0x2240(8768)~0x225F(8799)	Slot#20	0x2260(8800)~0x227F(8831)
Slot#21	0x2280(8832)~0x229F(8863)	Slot#22	0x22A0(8864)~0x22BF(8895)
Slot#23	0x22C0(8896)~0x22DF(8927)	Slot#24	0x22E0(8928)~0x22FF(8959)
Slot#25	0x2300(8960)~0x231F(8991)	Slot#26	0x2320(8992)~0x233F(9023)
Slot#27	0x2340(9024)~0x235F(9055)	Slot#28	0x2360(9056)~0x237F(9087)
Slot#29	0x2380(9088)~0x239F(9119)	Slot#30	0x23A0(9120)~0x23BF(9151)
Slot#31	0x23C0(9152)~0x23DF(9183)	Slot#32	0x23E0(9184)~0x23FF(9215)
Slot#33	0x2400(9216)~0x241F(9247)	Slot#34	0x2420(9248)~0x243F(9279)
Slot#35	0x2440(9280)~0x245F(9311)	Slot#36	0x2460(9312)~0x247F(9343)
Slot#37	0x2480(9344)~0x249F(9375)	Slot#38	0x24A0(9376)~0x24BF(9407)
Slot#39	0x24C0(9408)~0x24DF(9439)	Slot#40	0x24E0(9440)~0x24FF(9471)
Slot#41	0x2500(9472)~0x251F(9503)	Slot#42	0x2520(9504)~0x253F(9535)
Slot#43	0x2540(9536)~0x255F(9567)	Slot#44	0x2560(9568)~0x257F(9599)
Slot#45	0x2580(9600)~0x259F(9631)	Slot#46	0x25A0(9632)~0x25BF(9663)
Slot#47	0x25C0(9664)~0x25DF(9695)	Slot#48	0x25E0(9696)~0x25FF(9727)
Slot#49	0x2600(9728)~0x261F(9759)	Slot#50	0x2620(9760)~0x263F(9791)
Slot#51	0x2640(9792)~0x265F(9823)	Slot#52	0x2660(9824)~0x267F(9855)
Slot#53	0x2680(9856)~0x269F(9887)	Slot#54	0x26A0(9888)~0x26BF(9919)
Slot#55	0x26C0(9920)~0x26DF(9951)	Slot#56	0x26E0(9952)~0x26FF(9983)
Slot#57	0x2700(9984)~0x271F(10015)	Slot#58	0x2720(10016)~0x273F(10047)
Slot#59	0x2740(10048)~0x275F(10079)	Slot#60	0x2760(10080)~0x277F(10111)
Slot#61	0x2780(10112)~0x279F(10143)	Slot#62	0x27A0(10144)~0x27BF(10175)
Slot#63	0x27C0(10176)~0x27DF(10207)		

# Specification

Address Offset	Expansion Slot#1	Expansion Slot#2	Expansion Slot#3	Expansion Slot#4	.....	Expansion Slot#63
+ 0x00(+0)	0x2000(8192)	0x2020(8224)	0x2040(8256)	0x2060(8288)	.....	0x27C0(10176)
+ 0x01(+1)	0x2001(8193)	0x2021(8225)	0x2041(8257)	0x2061(8289)	.....	0x27C1(10177)
+ 0x02(+2)	0x2002(8194)	0x2022(8226)	0x2042(8258)	0x2062(8290)	.....	0x27C2(10178)
+ 0x03(+3)	0x2003(8195)	0x2023(8227)	0x2043(8259)	0x2063(8291)	.....	0x27C3(10179)
+ 0x04(+4)	0x2004(8196)	0x2024(8228)	0x2044(8260)	0x2064(8292)	.....	0x27C4(10180)
+ 0x05(+5)	0x2005(8197)	0x2025(8229)	0x2045(8261)	0x2065(8293)	.....	0x27C5(10181)
+ 0x06(+6)	0x2006(8198)	0x2026(8230)	0x2046(8262)	0x2066(8294)	.....	0x27C6(10182)
+ 0x07(+7)	0x2007(8199)	0x2027(8231)	0x2047(8263)	0x2067(8295)	.....	0x27C7(10183)
+ 0x08(+8)	0x2008(8200)	0x2028(8232)	0x2048(8264)	0x2068(8296)	.....	0x27C8(10184)
+ 0x09(+9)	0x2009(8201)	0x2029(8233)	0x2049(8265)	0x2069(8297)	.....	0x27C9(10185)
+ 0x0A(+10)	0x200A(8202)	0x202A(8234)	0x204A(8266)	0x206A(8298)	.....	0x27CA(10186)
+ 0x0B(+11)	0x200B(8203)	0x202B(8235)	0x204B(8267)	0x206B(8299)	.....	0x27CB(10187)
+ 0x0C(+12)	0x200C(8204)	0x202C(8236)	0x204C(8268)	0x206C(8300)	.....	0x27CC(10188)
+ 0x0D(+13)	0x200D(8205)	0x202D(8237)	0x204D(8269)	0x206D(8301)	.....	0x27CD(10189)
+ 0x0E(+14)	0x200E(8206)	0x202E(8238)	0x204E(8270)	0x206E(8302)	.....	0x27CE(10190)
+ 0x0F(+15)	0x200F(8207)	0x202F(8239)	0x204F(8271)	0x206F(8303)	.....	0x27CF(10191)
+ 0x10(+16)	0x2010(8208)	0x2030(8240)	0x2050(8272)	0x2070(8304)	.....	0x27D0(10192)
+ 0x11(+17)	0x2011(8209)	0x2031(8241)	0x2051(8273)	0x2071(8305)	.....	0x27D1(10193)
+ 0x12(+18)	0x2012(8210)	0x2032(8242)	0x2052(8274)	0x2072(8306)	.....	0x27D2(10194)
+ 0x13(+19)	0x2013(8211)	0x2033(8243)	0x2053(8275)	0x2073(8307)	.....	0x27D3(10195)
+ 0x14(+20)	0x2014(8212)	0x2034(8244)	0x2054(8276)	0x2074(8308)	.....	0x27D4(10196)
+ 0x15(+21)	0x2015(8213)	0x2035(8245)	0x2055(8277)	0x2075(8309)	.....	0x27D5(10197)
+ 0x16(+22)	0x2016(8214)	0x2036(8246)	0x2056(8278)	0x2076(8310)	.....	0x27D6(10198)
+ 0x17(+23)	0x2017(8215)	0x2037(8247)	0x2057(8279)	0x2077(8311)	.....	0x27D7(10199)
+ 0x18(+24)	0x2018(8216)	0x2038(8248)	0x2058(8280)	0x2078(8312)	.....	0x27D8(10200)
+ 0x19(+25)	0x2018(8217)	0x2038(8249)	0x2058(8281)	0x2078(8313)	.....	0x27D9(10201)
+ 0x1A(+26)	0x201A(8218)	0x203A(8250)	0x205A(8282)	0x207A(8314)	.....	0x27DA(10202)
+ 0x1B(+27)	0x201B(8219)	0x203B(8251)	0x205B(8283)	0x207B(8315)	.....	0x27DB(10203)
+ 0x1C(+28)	0x201C(8220)	0x203C(8252)	0x205C(8284)	0x207C(8316)	.....	0x27DC(10204)
+ 0x1D(+29)	0x201D(8221)	0x203D(8253)	0x205D(8285)	0x207D(8317)	.....	0x27DD(10205)
+ 0x1E(+30)	0x201E(8222)	0x203E(8254)	0x205E(8286)	0x207E(8318)	.....	0x27DE(10206)
+ 0x1F(+31)	0x201F(8223)	0x203F(8255)	0x205F(8287)	0x207F(8319)	.....	0x27DF(10207)

Address Offset	Access	Type, Size	Description
+ 0x00(+0)	Read	1 word	Slot module id.
+ 0x02(+2) **	Read	1 word	Input start register address of input image word this slot.
+ 0x03(+3) **	Read	1 word	Input word's bit offset of input image word this slot.
+ 0x04(+4) **	Read	1 word	Output start register address of output image word this slot.
+ 0x05(+5) **	Read	1 word	Output word's bit offset of output image word this slot.
+ 0x06(+6) **	Read	1 word	Input bit start address of input image bit this slot.
+ 0x07(+7) **	Read	1 word	Output bit start address of output image bit this slot.
+ 0x08(+8) **	Read	1 word	Size of input bit this slot
+ 0x09(+9) **	Read	1 word	Size of output bit this slot
+ 0x0A(+10)**	Read	n word	Read input data this slot
+ 0x0B(+11)**	Read/Write	n word	Read/write output data this slot
+ 0x0E(+14)	Read	1 word	GT-number, if GT-22CA, returns 0x22CA
+ 0x0F(+15)	Read	String upto 72bytes	First 1 word is length of valid character string. If GT-22CA, returns "00 1C 47 54 2D 32 32 43 41 2C 20 33 32 44 4F 2C 20 32 34 56 64 63 2C 20 53 6F 75 72 63 65" Valid character size = 0x001E =30 characters, "GT-22CA, 32DO, 24Vdc, Source"

# Specification

+ 0x10(+16)	Read	1 word	Size of configuration parameter byte
+ 0x11(+17)**	Read/Write	n word	Read/write Configuration parameter data, up to 8byte. ***
+ 0x17(+23)	Read	2 words	Firmware Revision
+ 0x18(+24)	Read	1 word	G-Bus Revision
+ 0x19(+25)	Read	2 words	Firmware release data.

\* After the system is reset, the new “Set Value” action is applied.

\*\* Nothing of output, input, memory or configuration parameter corresponding slot returns Exception 02.

## 4.3. Supported MODBUS Function Codes

MODBUS Reference Documents

<http://www.modubs.org>

MODBUS Tools

<http://www.modbustools.com>, modbus poll

<http://www.win-tech.com>, modscan32



**IP SYSTEMES**

8 rue du Colonel Chambonnet – BP67

69672 BRON Cedex

Tel. : 04 72 14 18 00

Fax : 04 72 14 18 01

[www.ip-systemes.com](http://www.ip-systemes.com) – [info@ip-systemes.fr](mailto:info@ip-systemes.fr)