



CC-Link Network Adapter **GN-9231** User Manual



Version 1.01

2020 CREVIS Co.,Ltd

DOCUMENT CHANGE SUMMARY				
REV	PAGE	REMARKS	DATE	EDITOR
1.0	New Document		2019/1/31	CH Hong
1.01	8	UL Certification	2020/7/31	CH Hong

CONTENTS

1.	Important Notes	5
1.1.	Safety Instruction	6
1.1.1.	Symbols	6
1.1.2.	Safety Notes	6
1.1.3.	Certification	6
2.	Specification	7
2.1.	The Interface	7
2.1.1.	GN-9231	7
2.2.	Specification	8
2.2.1.	General Specification	8
2.2.2.	Interface Specification	9
2.3.	LED Indicator	10
2.3.1.	L RUN LED (L RUN)	10
2.3.2.	L ERR LED (L ERR)	10
2.3.3.	RD LED (RD)	10
2.3.4.	SD LED (SD)	10
2.3.5.	Field Power Status LED	11
2.3.6.	Expansion Module Status LED (I/O)	11
3.	Dimension	12
3.1.	GN-9231	12
4.	Mechanical Set Up	13
4.1.	Total Expansion	13
4.2.	Plugging and Removal of the Components	13
4.3.	Internal FnBus/Field Power Contacts	14
5.	CC-Link Electrical Interface	15
5.1.	FnBus System	15
5.2.	CC-Link Network Installation	17
5.2.1.	GN-9231 Cable Specification	17
5.2.2.	Connector	18
5.2.3.	Minimum radius of bending cable	19
5.2.4.	Terminator Resistor	19
5.2.5.	CC-Link Setting	21
5.2.6.	CC-Link Network Setup	22
5.3.	Example (Connect with MELSEC)	26
5.4.	Process Image	29
5.4.1.	Remote input area	29

5.4.2. Remote output area	29
5.4.3. RWr/RWw area	29
5.4.4. System area	30
5.4.5. Reaction on network error	30
5.4.6. Service Message	31
5.4.7. Service Message request	31
5.4.8. Service Message response	32
6. Trouble Shooting	33
6.1. How to diagnose by LED indicator	33
APPENDIX A	35
A.1. Product List	35
A.2. Glossary	37

1. Important Notes

Solid state equipment has operational characteristics differing from those of electromechanical equipment. Safety Guidelines for the Application, Installation and Maintenance of Solid State Controls describes some important differences between solid state equipment and hard-wired electromechanical devices. Because of this difference, and also because of the wide variety of uses for solid state equipment, all persons responsible for applying this equipment must satisfy themselves that each intended application of this equipment is acceptable.

In no event will CREVIS be responsible or liable for indirect or consequential damages resulting from the use or application of this equipment.

The examples and diagrams in this manual are included solely for illustrative purposes. Because of the many variables and requirements associated with any particular installation, CREVIS cannot assume responsibility or liability for actual use based on the examples and diagrams.

Warning!

If you don't follow the directions, it could cause a personal injury, damage to the equipment or explosion

Do not assemble the products and wire with power applied to the system. Else it may cause an electric arc, which can result into unexpected and potentially dangerous action by field devices. Arching is explosion risk in hazardous locations. Be sure that the area is non-hazardous or remove system power appropriately before assembling or wiring the modules.

Do not touch any terminal blocks or IO modules when system is running. Else it may cause the unit to an electric shock or malfunction.

Keep away from the strange metallic materials not related to the unit and wiring works should be controlled by the electric expert engineer. Else it may cause the unit to a fire, electric shock or malfunction.

Caution!

If you disobey the instructions, there may be possibility of personal injury, damage to equipment or explosion. Please follow below Instructions.

Check the rated voltage and terminal array before wiring. Avoid the circumstances over 50°C of temperature. Avoid placing it directly in the sunlight.

Avoid the place under circumstances over 85% of humidity.

Do not place Modules near by the inflammable material. Else it may cause a fire.



Do not permit any vibration approaching it directly.

Go through module specification carefully, ensure inputs, output connections are made with the specifications. Use standard cables for wiring.

Use Product under pollution degree 2 environment.

1.1 Safety Instruction

1.1.1 Symbols

<p>DANGER</p> 	<p>Identifies information about practices or circumstances that can cause an explosion in a hazardous environment, which may lead to personal injury or death property damage or economic loss.</p>
<p>IMPORTANT</p>	<p>Identifies information that is critical for successful application and understanding of the product.</p>
<p>ATTENTION</p> 	<p>Identifies information about practices or circumstances that can lead to personal injury, property damage, or economic loss. Attentions help you to identify a hazard, avoid a hazard, and recognize the consequences.</p>

1.1.2 Safety Notes

<p>DANGER</p> 	<p>The modules are equipped with electronic components that may be destroyed by electrostatic discharge. When handling the modules, ensure that the environment (persons, workplace and packing) is well grounded. Avoid touching conductive components, e.g. FnBUS Pin.</p>
--	--

1.1.3 Certification

c-UL-us UL Listed Industrial Control Equipment, certified for U.S. and Canada
See UL File E235505

CE Certificate

EN 61000-6-2; Industrial Immunity

EN 61000-6-4; Industrial Emissions

2. Specification

2.1 The Interface

2.1.1 GN-9231

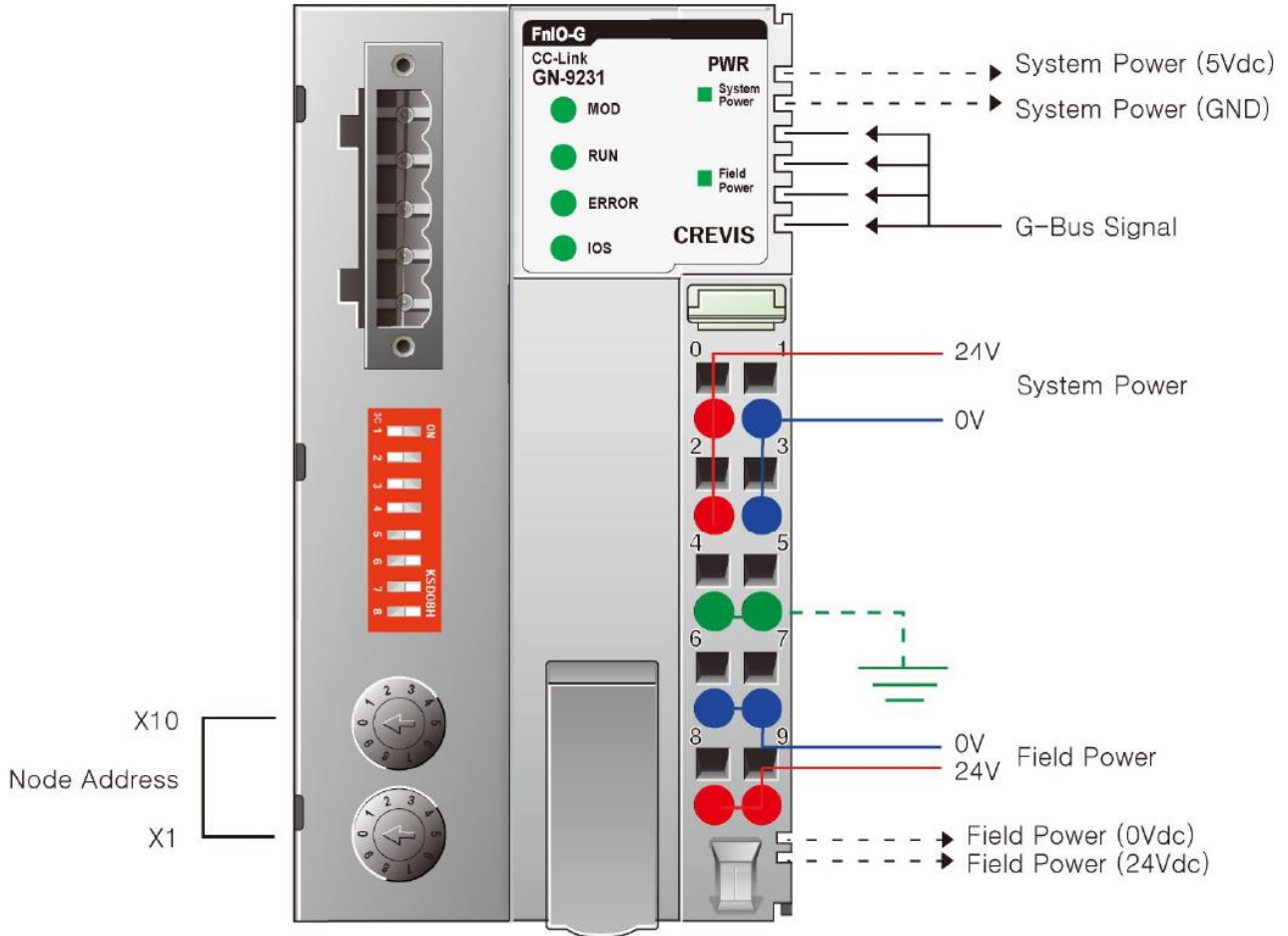

2.2 Specification

2.2.1 General Specification

Environmental specification	
Operating Temperature	60°C ~ 70°C : Power dissipation is limited to 0.8A. -40°C ~ 60°C : 1.5A full load is allowed.
UL Temperature	-20°C~60°C
Storage Temperature	-40°C~85°C
Relative Humidity	5% ~ 90% non-condensing
Mounting	DIN rail
General specification	
Shock Operating	IEC 60068-2-27
Vibration Resistance	Based on IEC 60068-2-6 DNVGL-CG-0039 : Vibration Class B, 4g
Industrial Emissions	EN 61000-6-4/A11 : 2011
Industrial Immunity	EN 61000-6-2 : 2005
Installation Position	Vertical and horizontal installation is available.
Product Certifications	CE, UL, FCC

2.2.2 Input Specification

Items	Specification
Communication Specification	
Adapter Type	Slave node (CC-Link Version 1)
Max. Expantsion Module	63slots
I/O Data size	System area : 16 points RX/RX : 112 points(4staion occupied) RWr/RWw : 16 points(4station occupied)
Max. Nodes number	42 Node/Max
Baud Rate	156/625/2500/5000/10000Kbps
Interface Connector	5 Pin open connector
Other Serial Port	RS232 for MODBUS/RTU, Touch Panel or IOGuide
Serial Configuration (RS232)	Node : 1 (Fixed) Baud Rate : 115200 (Fixed) Data bit : 8 (Fixed) Parity bit : No parity (Fixed) Stop bit : 1 (Fixed)
Indicator	6 LED 1 Green/Red, Module Status (MOD) 1 Green, Current Running Status (NET) 1 Green, Error Status (ERROR) 1 Green/Red Expansion I/O Module Status (IOS) 1 Green, System Power Status 1 Green, Field Power Status
Module Location	Starter module left side of G-bus system
Field Power Detection	About 14Vdc
Station class	Remote Device station
General specification	
UL System Power	Supply voltage : 24Vdc nominal, Class 2
System Power	Supply voltage : 24Vdc nominal Supply voltage range : 15~30Vdc Protection : Output current limit (Min. 1.5A) Reverse polarity protection
Power Dissipation	70mA typical @ 24Vdc
Current for I/O Module	1.5A @ 5Vdc(When using in '60°C ~ 70 °C' temperature environment, the power dissipation is limited to 0.8A.)
Isolation	System power to internal logic : Non-isolation System power I/O driver : Isolation
UL Field Power	Supply voltage : 24Vdc nominal, Class 2
Field Power	Supply voltage : 24Vdc nominal(Max. 30Vdc) * Field Power Range is different depending on IO Module series. Refer to IO Module`s Specification.
Max. Current Field Power Contact	DC 10A Max
Wiring	I/O Cable Max. 2.0mm ² (AWG 14)
Torque	0.8Nm(7 lb-in)
Weight	<165g
Module Size	54mm x 99mm x 70mm
Environment Condition	Refer to '1. Environment Specification'

2.3 LED Indicator

2.3.1 MOD (Module Status LED)

Status	LED is :	To indicate :
Not Powered	OFF	Not power is supplied to the unit.
Normal, Operational	Green	The unit is operating in normal condition.
Devicce in Standby	RED	The EEPROM parameter is not initialalized yet. Serial Number is zero value (0x00000000)

2.3.2 RUN (Network State LED)

Status	LED is :	To indicate :
Init / No Communication	Red	No Communication / Communication Disconnection
Communicaion	Green	Normal Communication
Communication Error	Off	Communication Error / Token passing

2.3.3 ERROR (Error State LED)

Status	LED is :	To indicate :
No Error	Off	
Invalid Configuration	Flashing Red	TBD

2.3.4 IOS LED (G-Bus Status LED)

Status	LED is :	To indicate :
Not Powered No Expansion Module	OFF	Device has no expansion module or may not be powered.
No Expansion Module	Flashing Red	Adapter has no expansion module
Internal Bus Connection, Run Exchanging I/O	Green	Exchanging I/O data.
Expansion Configuration Failed	Red	One or more expansion module occurred in fault state. <ul style="list-style-type: none"> - Detected invalid expansion module ID. - Too many expansion module - Initialization failure - Overflowed Input/Output Size - Communication failure. - Changed expansion module configuration. - Mismatch vendor code between adapter and expansion module.

2.3.5 Field Power LED (Field Power, LED)

Status	LED is :	To indicate :
Not Supplied Field Power	Off	Not supplied 24Vdc field power
Supplied Field Power	Green	Supplied 24Vdc field power

2.3.6 Expansion Module Status LED (I/O)

LED ON	Constantly ON
LED OFF	Constantly OFF.
LED flickering	Equal ON and OFF times with a frequency of approximately 10 Hz: ON for approximately 50ms and OFF for approximately 50ms.
LED blinking	Equal ON and OFF times with a frequency of approximately 2, 5Hz: ON for approximately 200ms followed by OFF for approximately 200ms.
LED single flash	One short flash (approximately 200ms) followed by a long OFF phase (approximately 1000ms)
LED double flash	A sequence of two short flashes (approximately 200ms), separated by an OFF phase (approximately 200ms). The sequence is finished by a long OFF phase (approximately 1000ms)
LED triple flash	A sequence of three short flashes (approximately 200ms), separated by an OFF phase (approximately 200ms). The sequence is finished by a long OFF phase (approximately 1000ms)

3. Dimension

3.1 GN-9231

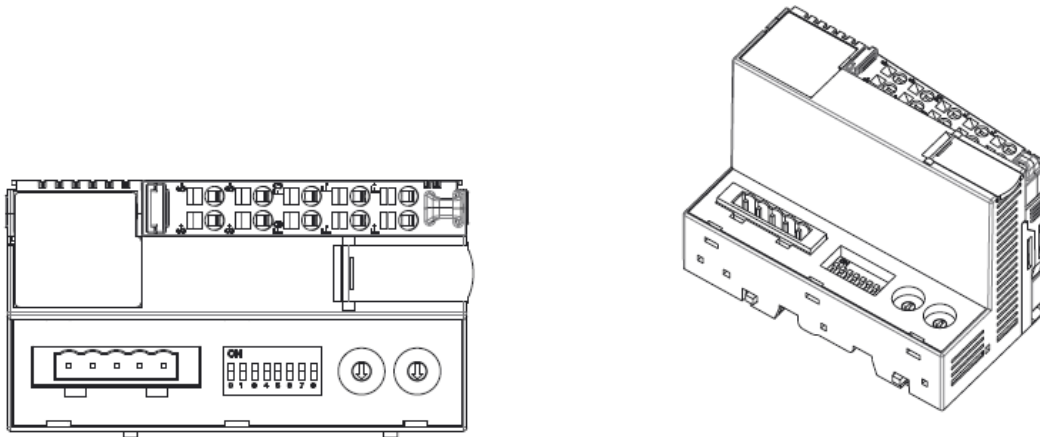
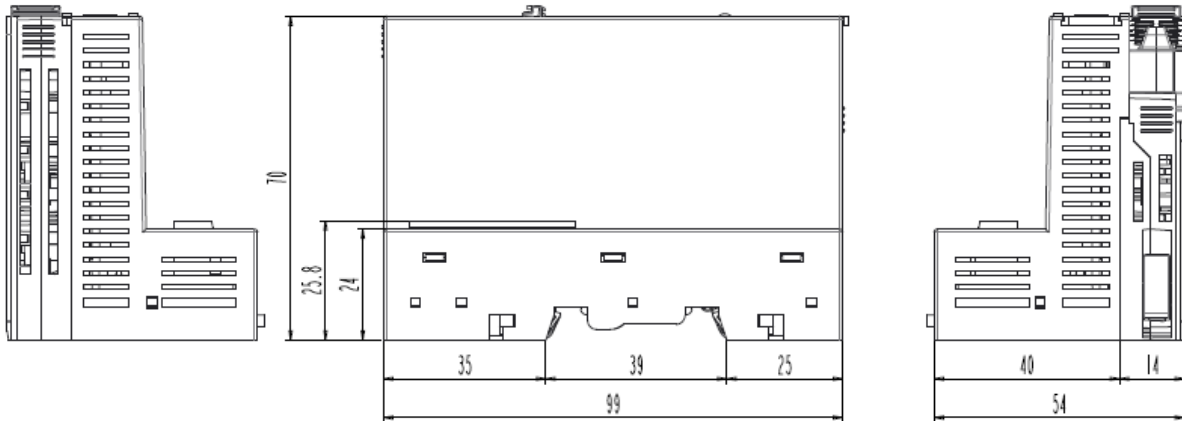

4. Mechanical Set Up

4.1 Total Expansion

The number of the module assembly that can be connected is 63.

4.2 Plugging and Removal of the Components.



Before work is done on the components, the voltage supply must be turned off.





As above figure in order to safeguard the FnIO module from jamming, it should be fixed onto the DIN rail with locking level. To do so, fold on the upper of the locking lever.

To pull out the FnIO module, unfold the locking lever as below figure.

4.3 Internal FnBus/Field Power Contacts

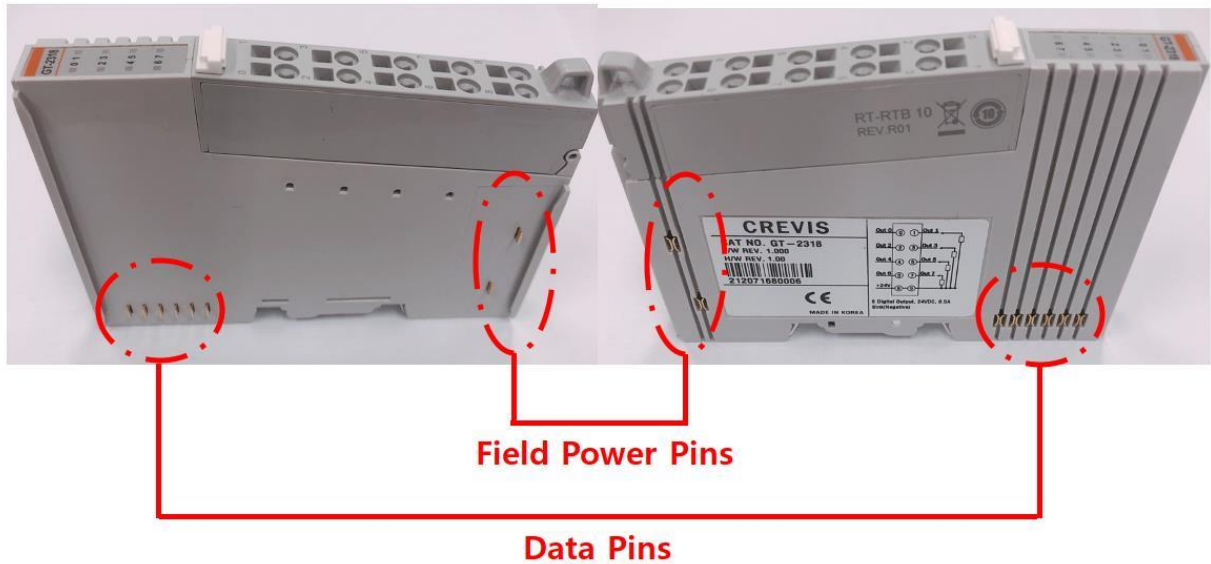
Communication between the NA series and the expansion module as well as system / field power supply of the bus modules is carried out via the internal bus. It is comprised of 6 data pin and 2 field power pin.



<p>DANGER</p> 	<p>Do not touch data and field power pins in order to avoid soiling and damage by ESD noise.</p>
--	--

5. CC-Link Electrical Interface

5.1 G-Bus System

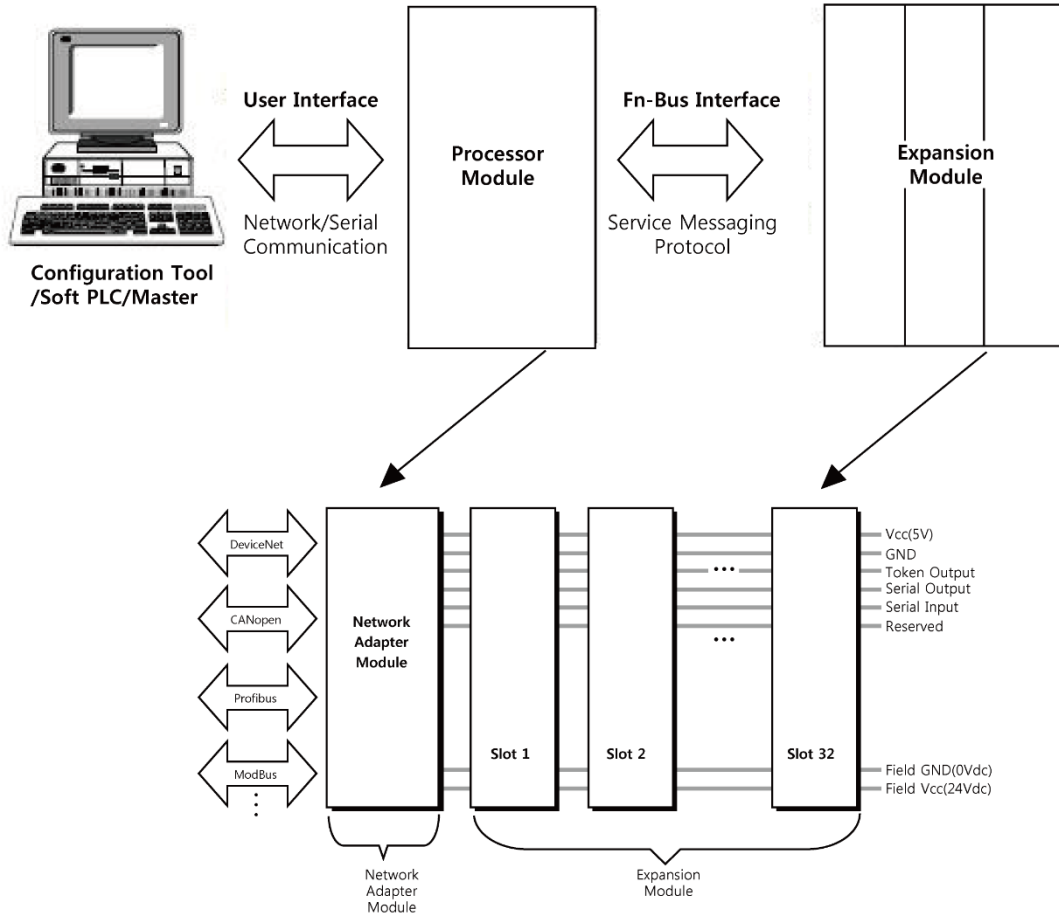

• Network Adapter Module

The Network Adapter Module forms the link between the field bus and the field devices with the Expansion Modules.

The connection to different field bus systems can be established by each of the corresponding Network Adapter Module, e.g. for SyncNet, PROFIBUS, CANopen, DeviceNet, Ethernet/IP, CC-Link, MODBUS/Serial, MODBUS/TCP etc.

- **Expansion Module**

The Expansion Modules are supported a variety of input and output field devices. There are digital and analog input/output modules and special function modules.

- **Two types of G-Bus Message**

- Service Messaging
- I/O Messaging

- **G-Bus Pin Description**

No.	Name	Description
1	Vcc	System supply voltage (5V dc).
2	GND	System Ground.
3	Token Output	Token output port of Processor module.
4	Serial Output	Transmitter output port of Processor module.
5	Serial Input	Receiver input port of Processor module.
6	Reserved	Reserved for bypass Token.
7	Field GND	Field Ground.
8	Field Vcc	Field supply voltage (24Vdc).

5.2 CC-Link Network Installation

5.2.1 GN-9231 Cable Specification

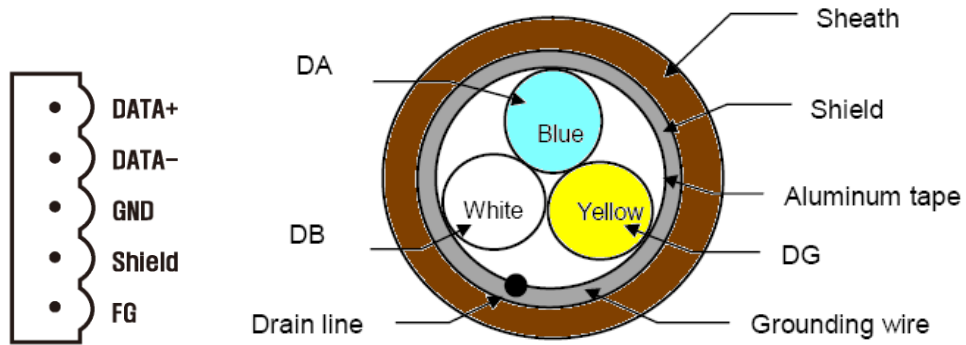

CC-Link dedicated cable shall be used in CC-Link system. Specification of CC-Link dedicated cable is as follow.

Item	Specifications	
Cable Type	Shield twisted cable	
Finish outer diameter	8.0mm or less	
Drain line	20 lines/0.18 mm or 24 lines/0.18mm Insert separately or in a bundle between the ground cable bundle and aluminum tape.	
Conductor resistance (20℃)	37.8Ω/km	
Insulation resistance	10000MΩ · km or more	
Withstand voltage	500VDC 1minute	
Electrostatic capacity(1kHz)	60nF/km or less	
Characteristic impedance	1 MHz	110±15Ω
	5 MHz	110±6Ω
Attenuation amount	1 MHz	1.6dB/100mor less
	5 MHz	3.5dB/100mor less

ATTENTION



The use of an incorrect supply voltage or frequency can cause severe damage to the component.

5.2.2 Connector

Recommended specifications of connector relaying between CC-Link dedicated cables are as followings.

M12(Micro) type(4 cores)

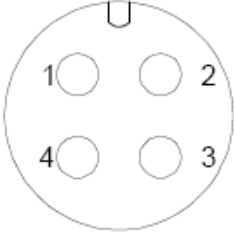
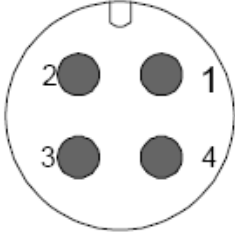
	M12 (Micro) Type	Pin Position	
Resistance of conductor	5mΩ or less	Female	Male
Thickness of Gold plate	0.1 μm or more		
Type of water proof	IP67 (JIS C 0920)		
Pin Position	1 pin : SLD 2 pin : DB 3 pin : DG 4 pin : DA		

Easy connection water proof type (4 cores)

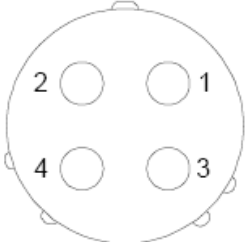
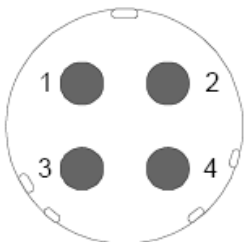
	Easy connection water proof type	Pin Position	
Resistance of conductor	5mΩ or less	Female	Male
Thickness of Gold plate	0.5 μm or more		
Type of water proof	IP67 (JIS C 0920)		
4 conductors	1 pin : SLD 2 pin : DB 3 pin : DG 4 pin : DA		

5.2.3 Minimum radius of bending cable

Please keep the minimum radius of bending in using CC-Link dedicated cable. When it is used with less than min. radius by constraint, it may cause pulling out from connector and cable, breaking of cable, etc..

Minimum radius of Bending cable	Connecting	Major diameter of cable × 10 or more
	Stable	Major diameter of cable × 4 or more

connecting : Minimum radius of bending cable permitted in only connecting

stable : Minimum radius of bending cable at stable permits the characteristic for long period.

5.2.4 Terminator Resistor

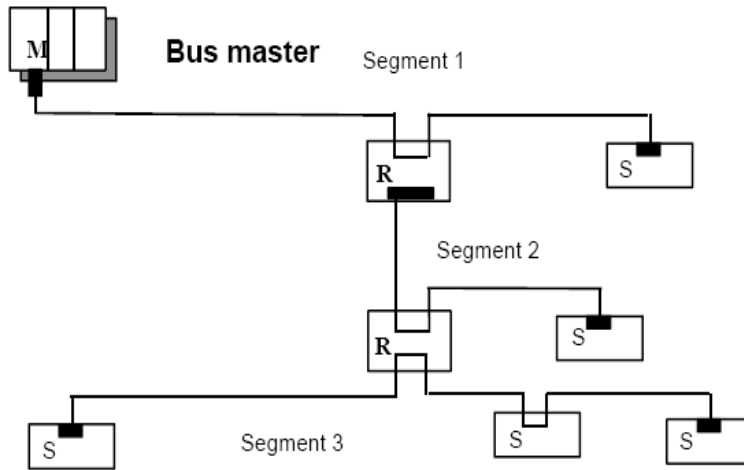

Legende:

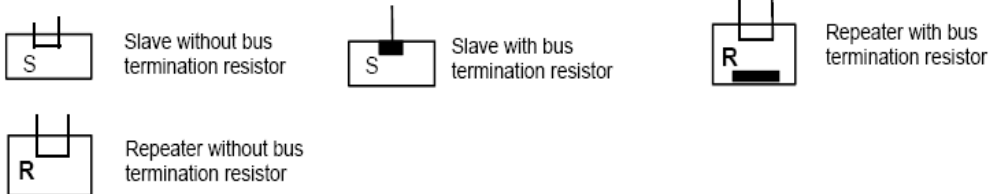

Specification of terminator Resistors are as follows Resistance Spec.:

- CC-Link dedicated cable $110\Omega \pm 5\%$ 1/2W
- CC-Link dedicate high performance cable $130\Omega \pm 5\%$ 1/2W

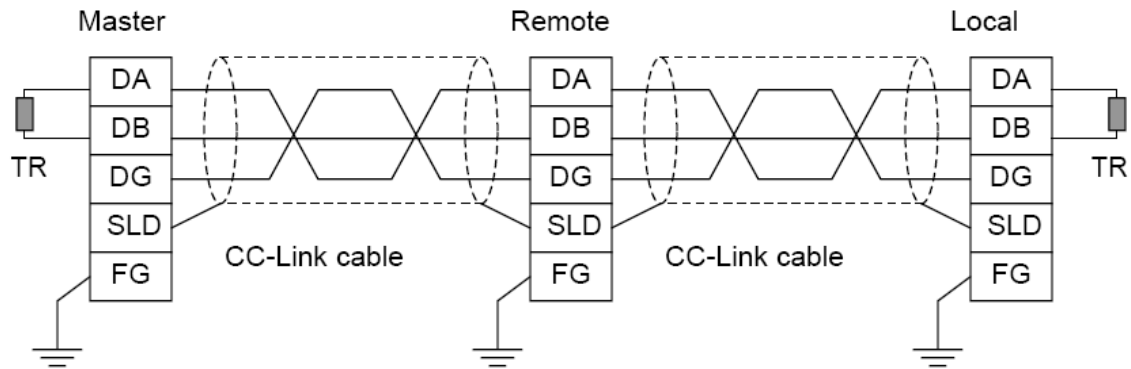

Easy connection water proof type (4 cores)

- When repeater is not used

Please connect terminal resistor, $110\Omega \pm 5\%$ 1/2W between DA and DB on each edge of trunk line.
(Do not use CC-Link dedicated high performance cable)

- When repeater is used

Please use Terminal resistor included in Repeater unit.

5.2.5 CC-Link Setting

Node Address Setting



- Node address set-up is rotary switch. Default Node Address is 1. Max node Address is 42.
Ex) When node address is set as 27: Device MAC ID Setting : (2*10 + 1*7) = 27

Baudrate Select Switch Setting



DIP Pole#	Description	
1	Fixed Station	OFF : Auto addressable ON : 4station Occupied
2	Baudrate #1	156Kbps : 2 OFF, 3OFF, 4 OFF 625Kbps : 2 ON, 3 OFF, 4 OFF
3	Baudrate #2	2.5Mbps : 2 OFF, 3ON, 4 OFF 5Mbps : 2 ON, 3 ON, 4 OFF
4	Baudrate #3	10Mbps : 2 OFF, 3 OFF, 4 ON Default Baudrate 156Kbps
5	Mode	Mode switch is ON, the IO size will be increased 2bytes more respectively
6	STOP ACTION	OFF : Master value dependent ON : Output Clear
7	Reserve	
8	Terminator Resistor	OFF : Terminator Resistor Non-set ON : Terminator Resistor Set

5.2.6 CC-Link Network Setup

<System configured with only Remote I/O station and /or Remote device>

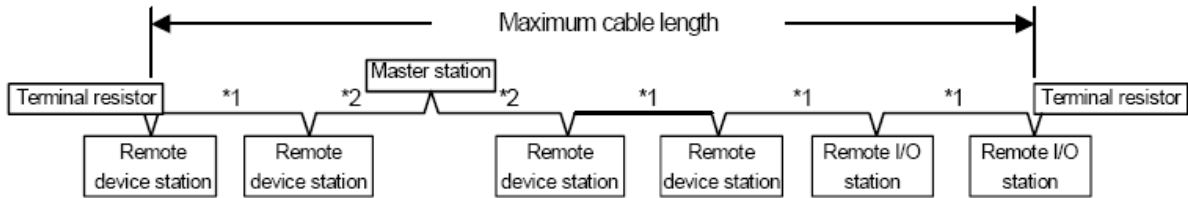

*1: Cable length between Remote I/O, Remote device and Remote I/O, Remote device.
 *2: Cable length between Master and next station.

<System including Local station and/ or Intelligent device station >

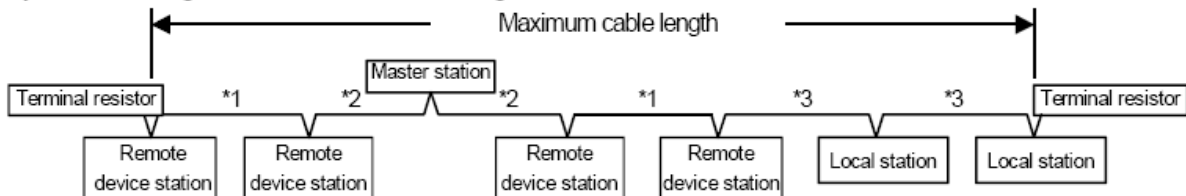

*1: Cable length between Remote I/O, Remote device and Remote I/O, Remote device.
 *2: Cable length between Master and next station.
 *3: Cable length between Local, Intelligent device and next station.

Connection of Shield line with ground

- Connect both edges of shield wire for CC-Link dedicated cable with "SLD" of each module.
- Connect "FG" of each module independently .
- Always ground the FG terminal to the protective ground conductor (Ground resistance 100Ω or less)
- If not use ground independently, use common ground according to the Figure.

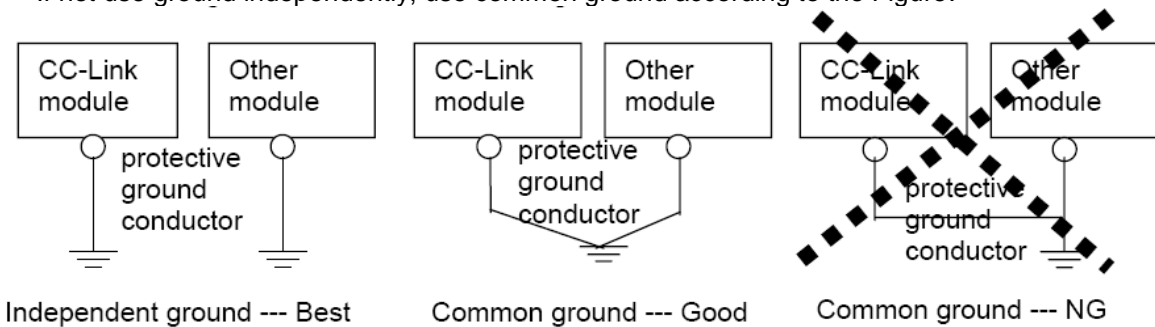

The Maximum length of network for each cable type is as follows

In case of CC-Link dedicated cable (Characteristic Impedance : 100Ω)

Communication Speed		156 Kbps	625 Kbps	2.5 Mbps	5 Mbps		10 Mbps		
Station-to-Station cable length	Between Master/Local, Intelligent device station and adjacent stations*	1m or more							
		2m or more							
	Between Remote I/O, Remote device and Remote I/O, Remote device stations (shortest cable) *	30cm or more	30cm or more	30cm or more	60cm or more	30~59cm or more	1m or more	60~99cm or more	30~59cm or more
Max. transmission distance		1200m	600m	200m	150m	110m	100m	80m	50m

* Upper line includes only Remote I/O, Remote device station. Lower line includes Local, Intelligent device station.

In case of CC-Link dedicated high performance cable (Characteristic Impedance: 130Ω)

Communication Speed		156 Kbps	625 Kbps	2.5 Mbps	5 Mbps		10 Mbps						
Station-to-Station cable length	Between Master/Local, Intelligent device station and adjacent stations*	1m or more											
		2m or more											
	Between Remote I/O, Remote device and Remote I/O, Remote device stations (shortest cable) *	30cm or more	30cm or more	30cm or more	60cm or more	30cm or more	1M or more	70cm or more	40~69cm	30~39cm	40cm or more	30~39cm	30cm or more
Max. No. of remote stations		64	64	64	64		64			48		32	
Max. transmission distance		1200m	900m	400m	-	160m	-	100m	30m	20m	100m	80m	100m
		1200m	600m	200m	150m	110m	80m	50m	-	-	-	-	-

* Upper line includes only Remote I/O, Remote device station. Lower line includes Local, Intelligent device station.

Network construction concept

Node	There are Master and Slave for Node , The master controls CC-Link and arranges external I/O. The Slave connect to external I/O. You can arrange
-------------	---

	Master and Slave in any position of Node as the above picture .
Trunk Line / Branch Line	A Trunk line means the cable attached terminal resistor on both edges. a Branch line means the cable branched off from trunk line. (Branch length: Max. 6M)
Terminal Resistor	The resistors are attached at both edges of cable. The resistor reduces reflected wave at terminal point and prevents disturbance of signal. Use resistors suitable for cable used. CC-Link dedicated cable $110\Omega\pm 5\%$ 1/2W CC-Link dedicated high flexible cable $130\Omega\pm 5\%$ 1/2W
Connection Type	CC-Link basic connection is multi drop connection. And T-branch connection is available in case of 625Kbps or less of communication speed or in case of using repeater .

T-Branch connection

- When repeater is not used

Please connect terminal resistor, $110\Omega\pm 5\%$ 1/2W between DA and DB on each edge of trunk line. (Do Not use CC-Link dedicated high performance cable)

- When repeater is used

Please use Terminal resistor included in Repeater unit.

Process and connection of CC-Link dedicated cable.

Process CC-Link dedicated cable according to the table, As well, refer to the table for the length of removed cable coat, the length of removed signal wire coat and terminal process of signal wire.

The length of removed cable coat	The length of removed signal wire coat	Terminal process of signal wire
50mm	3mm	Pressure terminal

Removing cable coat

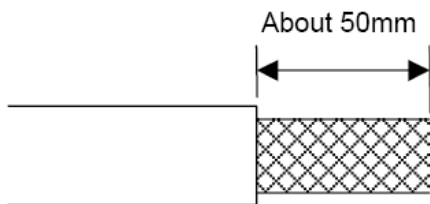

Remove CC-Link dedicated cable coat not to scratch shield mesh. But not remove extra amounts not to cause short.

Process shield

Ravel shield mesh carefully. As well as signal wire, there is one bare drain wire (stranded wire or each wire). Process the shield according to any of followings.

(1) When shield mesh is used

Coat with isolation tube after putting tightly shield mesh and drain wire together.

(2) When drain wire is used

Coat drain wire with isolation tube after trimming off the a excess shield mesh.

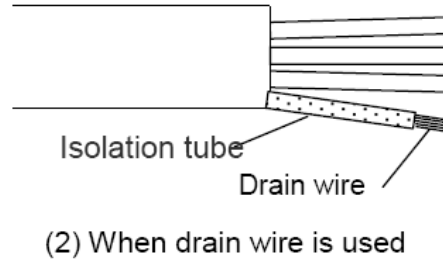
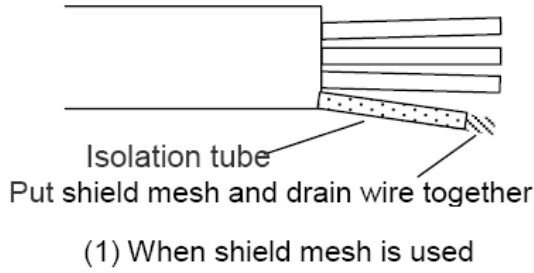

Remove signal wire coat

Remove coat of signal wire according to size of Pressure terminal. Put tightly bear signal wire together.

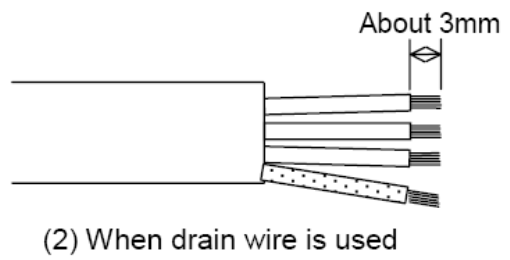
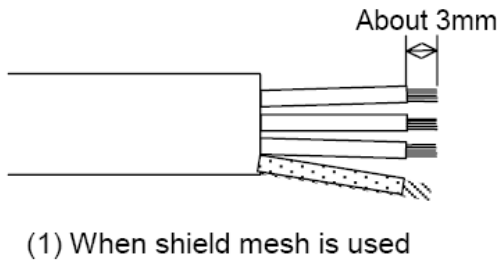

Connection pressure terminal

Connect signal wire removed coat, shield wire with pressure terminal differently.

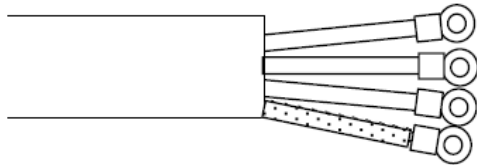

5.3 Example (Connect with MELSEC)

The 'GX Developer' runs.

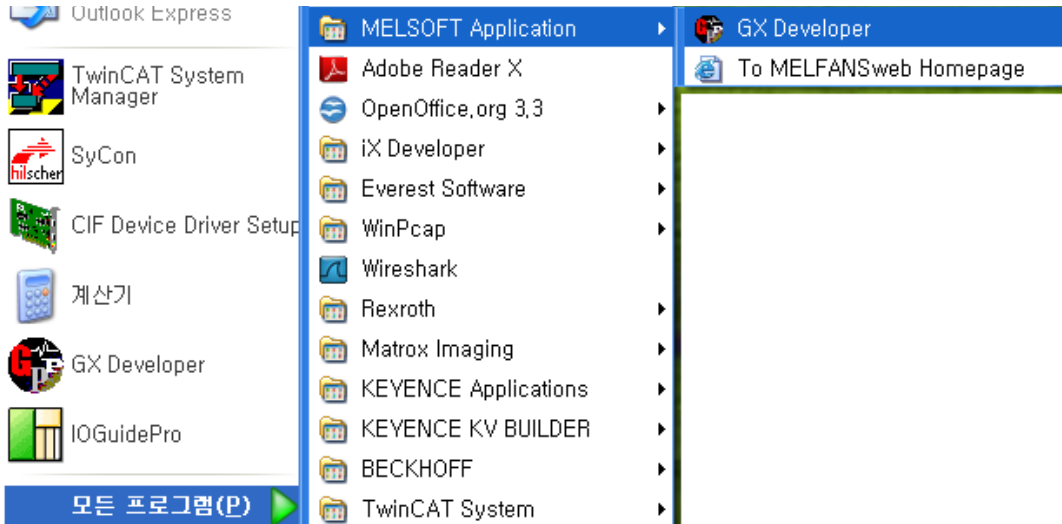

'GN-9231' and 'MELSEC' will to power on. And set the communication speed.

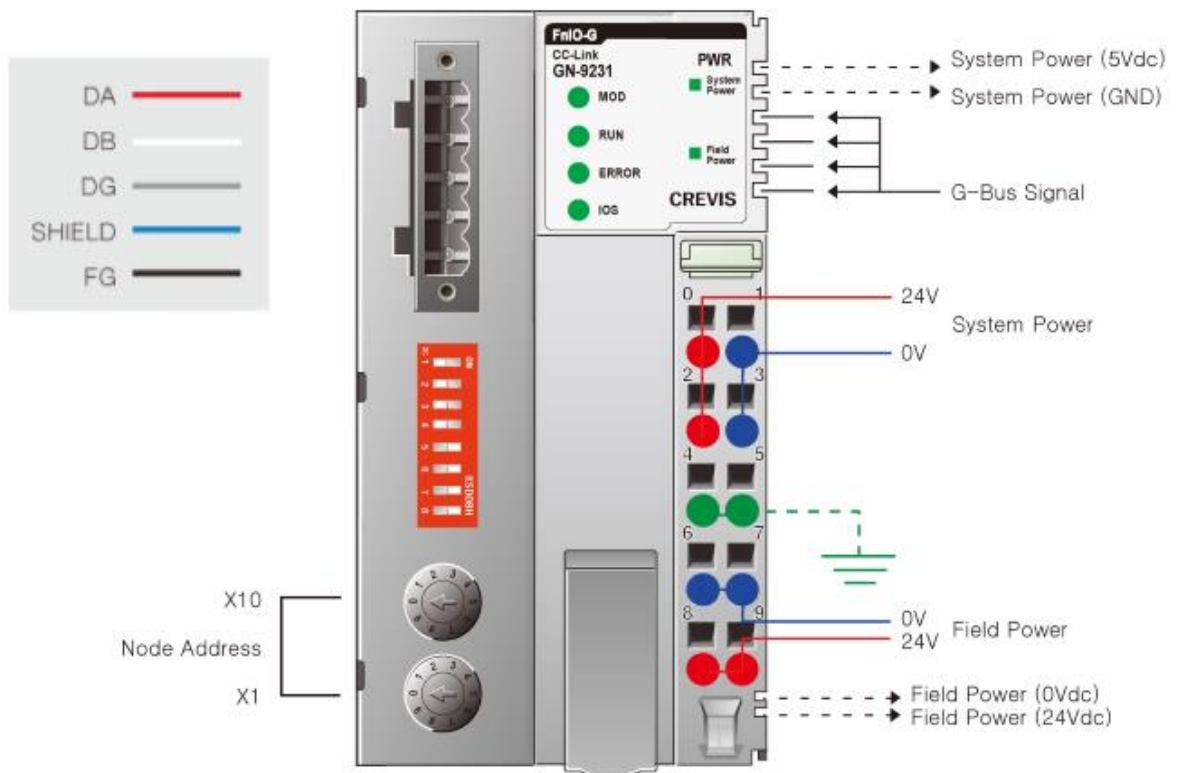

GN-9231 and MELSEC are same communication speed.

Project -> New project; We have QCPU. So PLC series setup is QCPU.

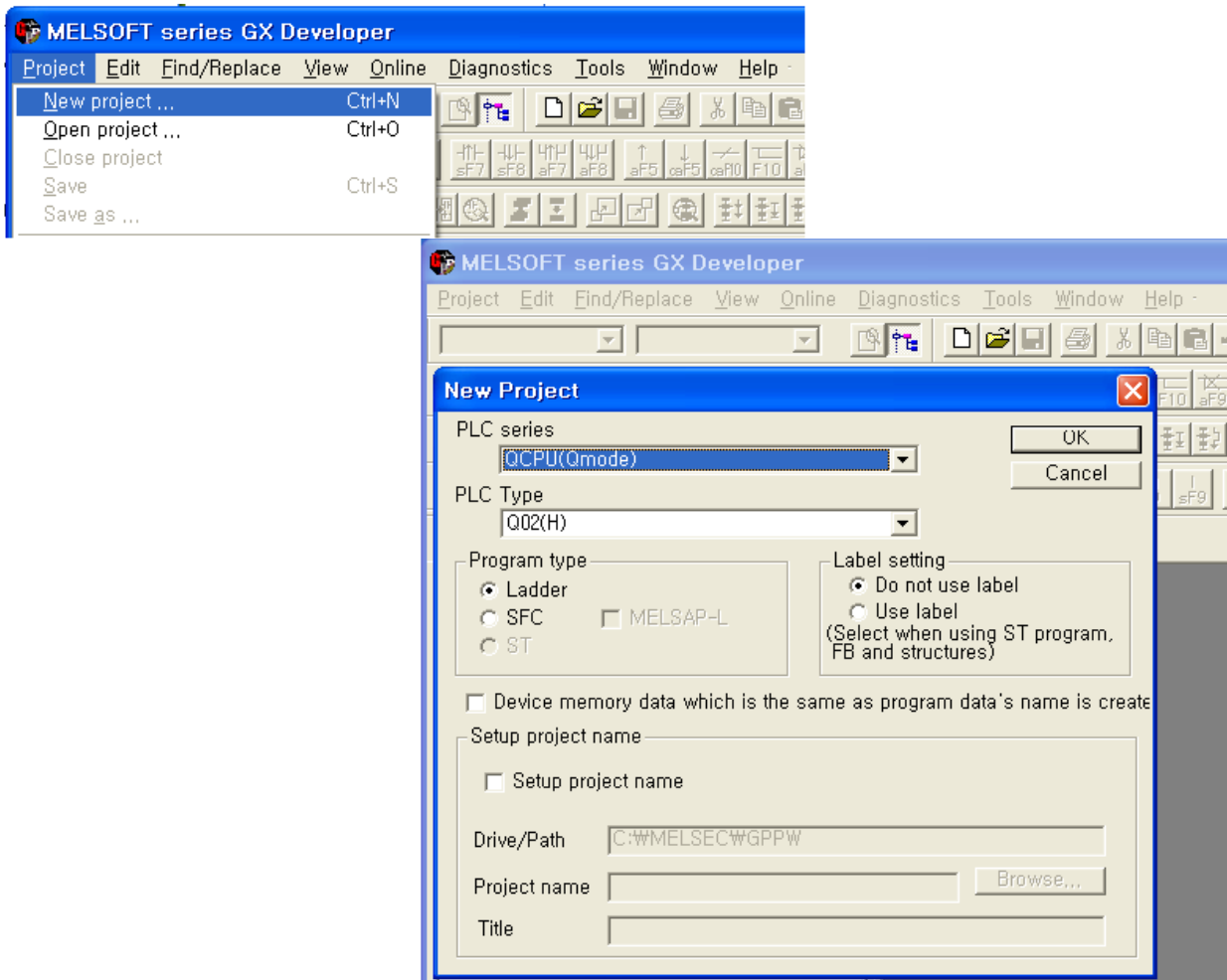

Option setting.

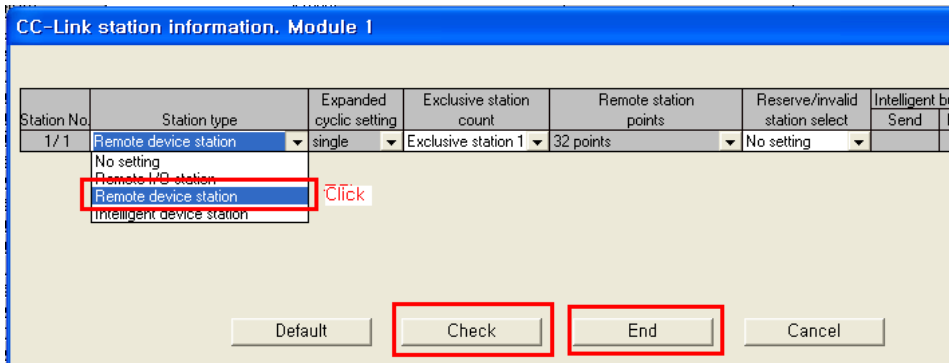
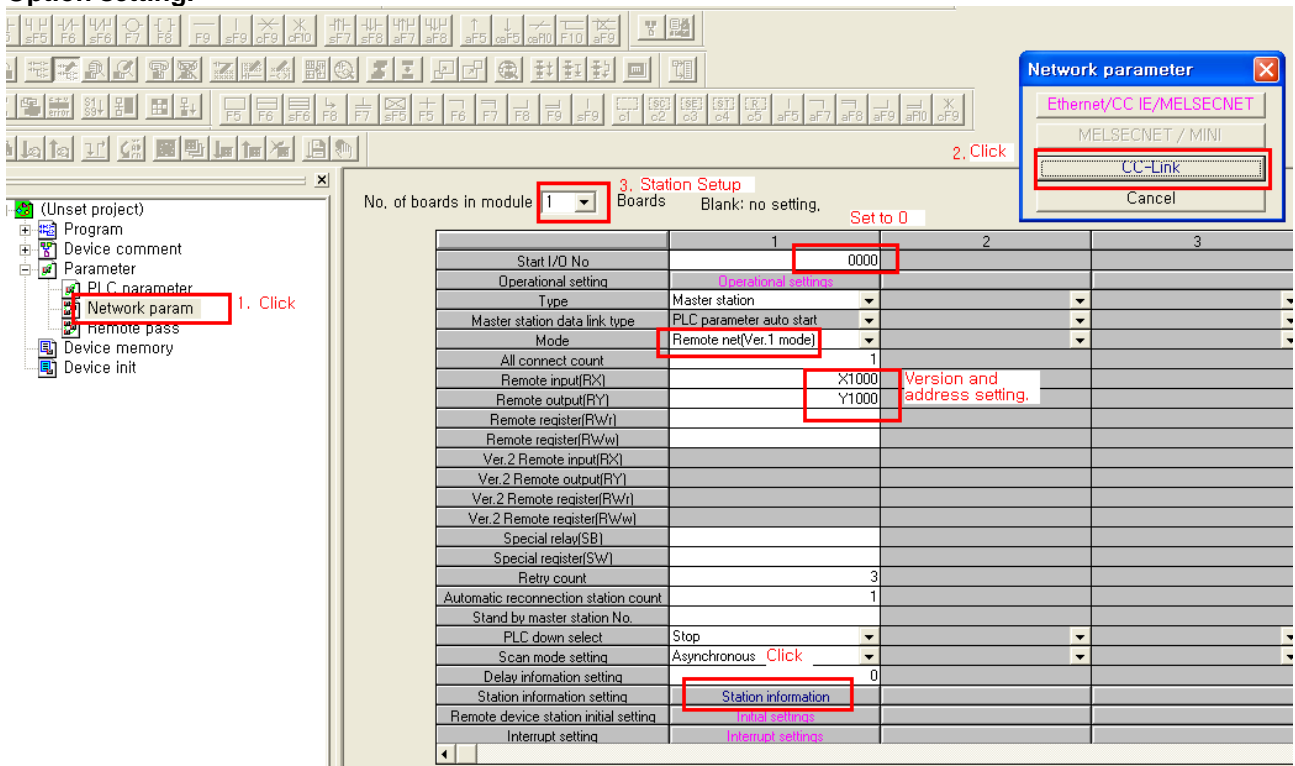

After setting, just click 'check'.
So Identify errors.

Download to PLC.

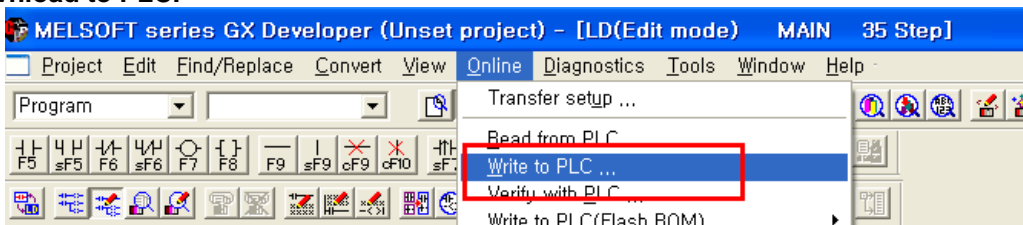

5.4 Process Image

5.4.1 Remote input area

No. of occupied station	Size	Signal name
1 station : 16points	2 bytes	Discrete input
2 station : 48points	6 bytes	
3 station : 80points	10 bytes	
4 station : 112points	14 bytes	
System area	2 bytes	System

When Mode switch is ON, the IO size will be increased 2bytes more respectively

5.4.2 Remote Output area

No. of occupied station	Size	Signal name
1 station : 16points	2 bytes	Discrete input
2 station : 48points	6 bytes	
3 station : 80points	10 bytes	
4 station : 112points	14 bytes	
System area	2 bytes	System

When Mode switch is ON, the IO size will be increased 2bytes more respectively

5.4.3 RWr/RWw area

Address	Configuration	Size	Signal name	Addresses	Configuration	Size	Signal name
RWr0 ~ RWr3	1 Station	4 Word	Analog in / Special module	RWw0 ~ RWw3	1 Station	4 Word	Analog out / Special module
RWr4 ~ RWr7	2 Station	8 Word		RWw4 ~ RWw7	2 Station	8 Word	
RWr8 ~ RWr11	3 Station	12 Word		RWw8 ~ RWw11	3 Station	12 Word	
RWr12 ~ RWr27	4 Station	16 Word		RWw12 ~ RWw27	4 Station	16 Word	

5.4.4 System area

Input	Description	Output	Description
RX0	Reaction on network error	RY0	Reaction on network error
RX1	Reaction on network error	RY1	Reaction on network error
RX2	Reserved	RY2	Reserved
RX3	Reserved	RY3	Reserved
RX4	Reserved	RY4	Reserved
RX5	Reserved	RY5	Reserved
RX6	Msg service ready	RY6	Msg service start request
RX7	Msg response completed	RY7	Msg request
RX8	Reserved	RY8	Reserved
RX9	Reserved	RY9	Reserved
RXA	Error status flag	RYA	Reserved
RXB	Remote station ready	RYB	Reserved
RXC	Reserved	RYC	Reserved
RXD	Reserved	RYD	Reserved
RXE	Reserved	RYE	Reserved
RXF	Reserved	RYF	Reserved

5.4.5 Reaction on network error

RY1	RY0	Description
0	0	Hold Last value
0	1	Clear output to zero
1	0	Stop Bus
1	1	Not used(internally switched to 10)

5.4.6 Service Message

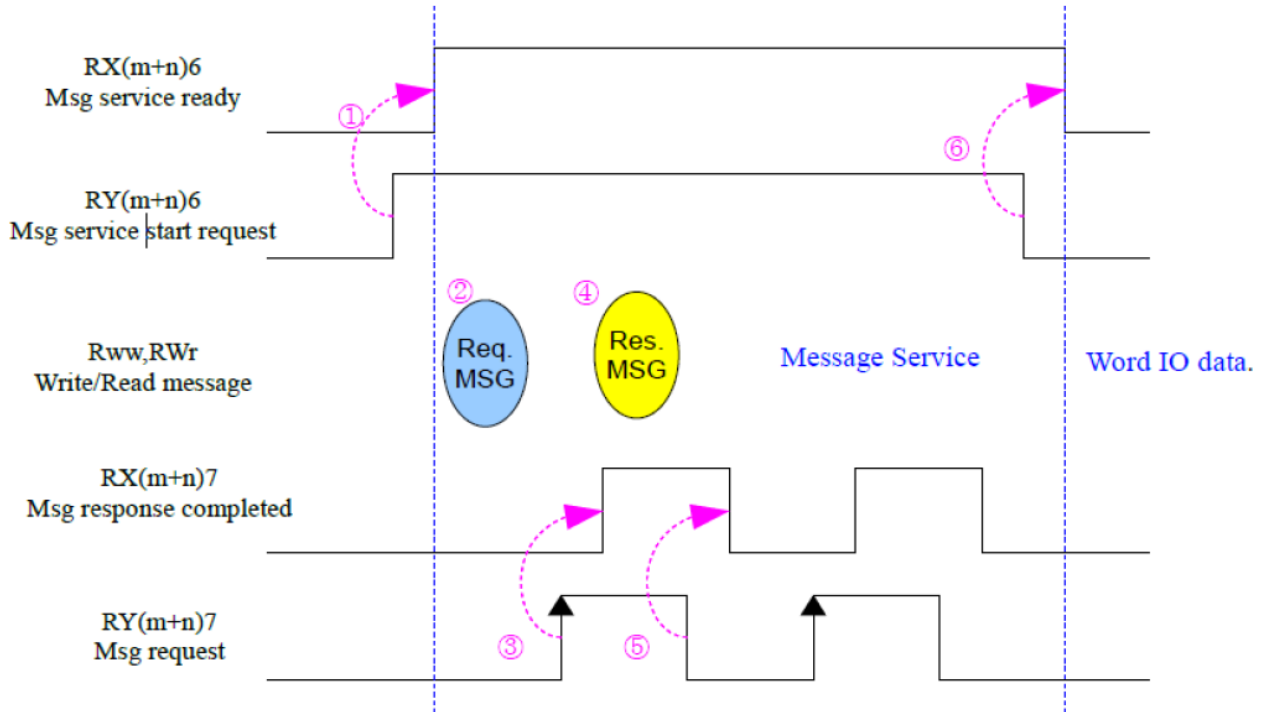

5.4.7 Service Message request

Address	High byte	Low byte	station
RWw[0]	Slot number	Service code - Read Parameter : 2 - Write Parameter : 3	1
RWw[1]	offset		
RWw[2]	User data length		
RWw[3]	User data 1	User data 0	2
RWw[4]	User data 3	User data 2	
RWw[5]	User data 5	User data 4	
RWw[6]	User data 7	User data 6	
RWw[7]	User data 9	User data 8	3
RWw[8]	User data 11	User data 10	
RWw[9]	User data 13	User data 12	
RWw[10]	User data 15	User data 14	4
RWw[11]	User data 17	User data 16	
RWw[12]	User data 19	User data 18	
RWw[13]	User data 21	User data 20	
RWw[14]	User data 23	User data 22	
RWw[15]	User data 25	User data 24	

5.4.8 Service Message response

Address	High byte	Low byte	station
RWr[0]	Slot number	Service code - Read Parameter : 2 - Write Parameter : 3	1
RWr[1]	offset		
RWr[2]	User data length		
RWr[3]	User data 1	User data 0	2
RWr[4]	User data 3	User data 2	
RWr[5]	User data 5	User data 4	
RWr[6]	User data 7	User data 6	
RWr[7]	User data 9	User data 8	
RWr[8]	User data 11	User data 10	3
RWr[9]	User data 13	User data 12	
RWr[10]	User data 15	User data 14	
RWr[11]	User data 17	User data 16	
RWr[12]	User data 19	User data 18	4
RWr[13]	User data 21	User data 20	
RWr[14]	User data 23	User data 22	
RWr[15]	User data 25	User data 24	

6. Trouble Shooting

6.1 How to diagnose by LED indicator

LED Status	Cause	Action
All LED turns off	- No power	- Check main power Cable
	- System power is not supplied.	- Contact Sales team and send module for repair.
L RUN LED turns off	- Device is not on-line or may not be powered. - Resetting Hardware - Device is Timeout	- Check main power Cable - Check the communication cable - Check the configuration with the respect to CC-Link in PLC program.
L ERR LED turns Flashing Red	- Switch setting has been changed from the setting at the reset cancellation.	- All of settings should be checked again.
L ERR LED turns Red	- CRC error - Invalid MAC ID - Baud rate switch setting error	- Contact Sales team and send module for repair. - Check Baud rate setting. - Check Node setting. - Check the configuration with the respect to CC-Link in PLC program.
I/O LED turns off	- Failure of realization expansion Module - None expansion Module	- Check connector status both NA series and expansion module.
I/O LED flashes red	Failure of configuration baud rate	- Check communication cable with Master - Check power for master.
	Failure of initialization I/O	- Use expansion slot up to 32. - Compose that IO total size is not excess. NA series notice unidentified expansion module ID. Check status of expansion module.
I/O LED is red	Failure of exchanging I/O data	Check status of expansion IO connection.
RD LED turns off	- Unable to detect carriers neither for channel 1 or 2	- Check the communication cable - Contact Sales team and send module for repair.
SD LED turns off	- Other than listed in the left	- Check Baud rate setting. - Check the communication cable - Contact Sales team and send module for repair.
Field Power Status LED turns off	- Other than listed in the left	- Check the connection of Field Power.

How to diagnose when device couldn't communicate network

Inspection of wrong or omission cable connection.

- Check status of cable connection for each node.
- Check that all color matches between connector and cable.
- Check wire omission.

Terminator resistor

- If terminator resistor is not installed, install terminator resistor
- Check location of terminator resistor

Configuration of Node address

- Check duplication node address.

Configuration of Master

- Check configuration of master
- Check whether to do download or don't
- Check composition is right
 - Configuration of communication baud rate
 - I/O size
 - Configuration of each node

Ground and environment

- Check ground is contacted
- Check environment factor (temperature, humidity, etc) is in less than regular limit

APPENDIX A

A.1. Product List

No.	GT-Number	Description	ID(hex)
Digital Input Module			
1	GT-1238	8 Points, Universal, 24Vdc, 10RTB	1238
2	GT-123F	16 Points, Universal, 24Vdc, 20P connector	123F
3	GT-12DF	16 Points, Universal, 24Vdc, 18RTB	12DF
4	GT-12FA	32 Points, Universal, 24Vdc, 40P connector	12FA
5	GT-1428	8 Sink Input / 8 Source Output with Diagnostic, 24Vdc	1428
6	GT-1804	4 Points, 120Vac, 10RTB	1804
7	GT-1904	4 Points, 240Vac, 10RTB	1904
Digital Output Module			
8	GT-2318	8 Points, Sink, 24Vdc/0.5A, 10RTB	2318
9	GT-2328	8 Points, Source, 24Vdc/0.5A, 10RTB	2328
10	GT-221F	16 Points, Sink, 24Vdc/0.3A, 20P connector	221F
11	GT-222F	16 Points, Source, 24Vdc/0.3A, 20P connector	222F
12	GT-225F	16 Points, Sink, 24Vdc/0.3A, 18RTB	225F
13	GT-226F	16 Points, Source, 24Vdc/0.3A, 18RTB	226F
14	GT-22BA	32 Points, Sink, 24Vdc/0.3A, 40P connector	22BA
15	GT-22CA	32 Points, Source, 24Vdc/0.3A, 40P connector	22CA
16	GT-2418	8 Channels Sink Output with Diagnostics	2418
17	GT-2428	8 Channels Source Output with Diagnostics	2428
18	GT-2618	8 Points, Sink, 24Vdc/2A, 10RTB	2618
19	GT-2628	8 Points, Source, 24Vdc/2A, 10RTB	2628
20	GT-2734	4 Points, MOS Relay, 240Vdc/ac, 0.5A, 10RTB	2734
21	GT-2738	8 Points, MOS Relay Output Terminal, 240Vdc, 0.5A	2738
22	GT-2744	4 Points, Relay, 24Vdc/2A, 240Vac/2A, 10RTB	2744
23	GT-2764	4 Points, MOS Relay, 24Vdc/ac, 2A, 10RTB	2764
24	GT-2768	8 Points, Relay Output Terminal, 24Vdc/ac, 2A	2768
25	GT-2784	4 Points, MOS Relay, 110Vdc/ac, 1A, 10RTB	2784
26	GT-2788	8 Points, Relay Output Terminal, 110Vdc/ac, 1A	2788
Analog Input Module			
27	GT-3002	2ch load cell input unit, strain gauge	3002
28	GT-3114	4 Channels, 0~20, 4~20mA, 12bits, 10RTB	3114
29	GT-3154	4 Channels, 0~20, 4~20mA, 16bits, 10RTB	3154
30	GT-3118	8 Channels, 0~20, 4~20mA, 12bits, 10RTB	3118
31	GT-3158	8 Channels, 0~20, 4~20mA, 16bits, 10RTB	3158
32	GT-311F	16 Channels, 0~20, 4~20mA, 12bits, 20P connector	311F
33	GT-315F	16 Channels, 0~20, 4~20mA, 16bits, 20P connector	315F
34	GT-317F	16 Channels, 0~20, 4~20mA, 12bits, 18RTB	317F
35	GT-319F	16 Channels, 0~20, 4~20mA, 16bits, 18RTB	319F
36	GT-3424	4 Channels, 0~10, 0~5, 1~5Vdc, 12bits, 10RTB	3424
37	GT-3464	4 Channels, 0~10, 0~5, 1~5Vdc, 16bits, 10RTB	3464
38	GT-3428	8 Channels, 0~10, 0~5, 1~5Vdc, 12bits, 10RTB	3428
39	GT-3468	8 Channels, 0~10, 0~5, 1~5Vdc, 16bits, 10RTB	3468
40	GT-342F	16 Channels, 0~10, 0~5, 1~5Vdc, 12bits, 20P connector	342F

41	GT-346F	16 Channels, 0~10, 0~5, 1~5Vdc, 16bits, 20P connector	346F
42	GT-347F	16 Channels, 0~10, 0~5, 1~5Vdc, 12bits, 18RTB	347F
43	GT-349F	16 Channels, 0~10, 0~5, 1~5Vdc, 16bits, 18RTB	349F
44	GT-3704	4 Channels, RTD, 10RTB	3704
45	GT-3708	8 Channels, RTD, 20P connector	3708
46	GT-3804	4 Channels, Thermocouple, 10RTB	3804
47	GT-3808	8 Channels, Thermocouple, 20P connector	3808
48	GT-3714	4 Channels, TEMP. Controller, RTD Input, SSR Output	3714
49	GT-3734	4 Channels, TEMP. Controller, RTD Input, Current Output	3734
50	GT-3814	4 Channels, TEMP. Controller, TC Input, SSR Output	3814
51	GT-3834	4 Channels, TEMP. Controller, TC Input, Current Output	3834
52	GT-3901	AC Measurement	3901
53	GT-3914	4 Channels, Differential, 0~20, 4~20, +/-20mA, 12Bits, 10RTB	3914
54	GT-3934	4 Channels, Differential, 0~20, 4~20, +/-20mA, 16Bits, 10RTB	3934
55	GT-3918	8 Channels, Differential, 0~20, 4~20, +/-20mA, 12Bits, 18RTB	3918
56	GT-3938	8 Channels, Differential, 0~20, 4~20, +/-20mA, 16Bits, 18RTB	3938
57	GT-3924	4 Channels, Differential, 0~5, 0~10, +/-5, +/-10Vdc, 12Bits, 10RTB	3924
58	GT-3944	4 Channels, Differential, 0~5, 0~10, +/-5, +/-10Vdc, 16Bits, 10RTB	3944
59	GT-3928	8 Channels, Differential, 0~5, 0~10, +/-5, +/-10Vdc, 12Bits, 18RTB	3928
60	GT-3948	8 Channels, Differential, 0~5, 0~10, +/-5, +/-10Vdc, 16Bits, 18RTB	3948
Analog Output Module			
61	GT-4114	4CH, 0~20mA, 12Bits, 10RTB	4114
62	GT-4154	4CH, 0~20mA, 16Bits, 10RTB	4154
63	GT-4118	8CH, 0~20mA, 12Bits, 10RTB	4118
64	GT-4158	8CH, 0~20mA, 16Bits, 10RTB	4158
65	GT-4214	4 Channels, Current Output, 4~20mA, 12bits	4214
66	GT-4254	4 Channels, Current Output, 4~20mA, 16bits	4254
67	GT-4218	8 CHANNELS CURRENT OUTPUT, 4~20mA, 12BIT	4218
68	GT-4258	8 CHANNELS CURRENT OUTPUT, 4~20mA, 16BIT	4258
69	GT-4424	4CH, 0~10Vdc, 12Bits, 10RTB	4424
70	GT-4464	4CH, 0~10Vdc, 16Bits, 10RTB	4464
71	GT-4428	8CH, 0~10Vdc, 12Bits, 10RTB	4428
72	GT-4468	8CH, 0~10Vdc, 16Bits, 10RTB	4468
73	GT-442F	16CH, 0~10Vdc, 12Bits, 20P Connector	442F
74	GT-446F	6CH, 0~10Vdc, 16Bits, 20P Connector	446F
75	GT-447F	16CH, 0~10Vdc, 12Bits, 18RTB	447F
76	GT-449F	16CH, 0~10Vdc, 16Bits, 18RTB	449F
77	GT-4524	AO 4 CHs, ±10Vdc, 12Bits, 10RTB	4524
78	GT-4564	AO 4 CHs, ±10Vdc, 16Bits, 10RTB	4564
Special Module			
79	GT-5102	2CH, Encoder, Input, 5Vdc, 10RTB	5102
80	GT-5112	High Speed Counter, 2CHs, 24Vdc, Encoder Input, 10RTB	5112
81	GT-5114	High Speed Counter, 4CHs, 24Vdc, Encoder Input, 10RTB	5114
82	GT-5211	1CH, RS 232, RTS/CTS, Full Duplex Type, 10RTB	5211
83	GT-5212	2CH, RS 232, Full Duplex Type, 10RTB	5212
84	GT-5221	1CH, RS 485, Full Duplex Type, 10RTB	5221
85	GT-5231	1CH, RS 485, Half Full Duplex Type, 10RTB	5231
86	GT-5232	2CH, RS 485, Half Full Duplex Type, 10RTB	5232

87	GT-5352	2CH, Synchronous Serial Interface Input, 10RTB	5352
88	GT-5442	PWM Output, 2CHs, 0.5A/24Vdc, Source, 18RTB	5442
89	GT-5444	PWM Output, 4CHs, 0.5A/24Vdc, Source, 18RTB	5444
90	GT-5642	Pulse Output, 2CHs, 0.5A/24Vdc, Source, 18RTB	5642
91	GT-5652	Pulse Output, 2CHs, RS422 (Differential), 18RTB	5652
92	GT-5521	1CH, Stepper Module (TBD)	5521
Power Module			
93	GT-7408	Shield Module	7408
94	GT-7508	Common for 0Vdc	7508
95	GT-7511	Power Expansion, In 24Vdc, Out 1A/5Vdc	7511
96	GT-7518	Common for 24Vdc	7518
97	GT-7588	Common for 0Vdc, 24Vdc	7588
98	GT-7641	Field Power, 5/24/48 Vdc, 110/220 Vac	7641
99	GT-7151	Noise Filter Module, 18RTB, None ID Type	7151
100	GT-7851	Noise Filter Module, 18RTB, ID Type	7851

A.2. Glossary

- System Power: The power for starting up CPU.
- Field Power: The power for input and output line.
- Terminator Resistor: Resistor for prevention reflected wave.
- EDS: Electronic Data Sheet.
- sinking: The method of input and output what device does not have power source.
- sourcing: The method of input and output what device have power source.



IP SYSTEMES

8 rue du Colonel Chambonnet – BP67

69672 BRON Cedex

Tel. : 04 72 14 18 00

Fax : 04 72 14 18 01

www.ip-systemes.com – info@ip-systemes.fr