



EtherCAT Network Adapter Light Version **GL-9086** User Manual



REV 1.00

2020 CREVIS Co., Ltd.

DOCUMENT CHANGE SUMMARY				
REV.	PAGES	REMARKS	DATE	Editor
1.00	New Document		2020/8/31	YE JEON

Contents

1. Important Notes	5
1.1. Safety Instruction	6
1.1.1. Symbols.....	6
1.1.2. Safety Notes	6
1.1.3. Certification	6
2. Environment Specification	7
3. General Description	7
3.1. GL-9086 Specification	7
3.2. GL-9086 Wiring Diagram	9
3.3. GL-9086 LED Indicator	10
3.3.1. LED Indicator.....	10
3.3.2. MOD (Module Status LED).....	10
3.3.3. RUN (Current Running Status LED).....	10
3.3.4. ERR (Error Status LED).....	11
3.3.5. IOS LED(Extension I/O Module Status LED).....	11
3.4. GL-9086 Electrical Interface.....	12
3.4.1. RJ-45 Socket	12
3.4.2. DIP Switch	12
3.5. EtherCAT ID Type Setup	13
3.5.1. Hot Connection On TwinCAT	13
3.6. I/O Process Image Map	15
3.6.1. Mapping Data into Image Table.....	16
3.6.2. Example of Input Process Image (Input Register) Map	20
3.6.3. Example of Output Process Image (Output Register) Map	21
4. Dimension	22
4.1. GL-9086	22
5. EtherCAT Basics	23
5.1. EtherCAT State Machine	23
5.2. CoE Interface	25
5.2.1. Parameter management in the EtherCAT system.....	25

5.2.2. Communication Objects	26
6. TROUBLE SHOOTING	28
APPENDIX A	30
A.1. Product List	30
A.2. Glossary	32

1. Important Notes

Solid state equipment has operational characteristics differing from those of electromechanical equipment. Safety Guidelines for the Application, Installation and Maintenance of Solid State Controls describes some important differences between solid state equipment and hard-wired electromechanical devices. Because of this difference, and also because of the wide variety of uses for solid state equipment, all persons responsible for applying this equipment must satisfy themselves that each intended application of this equipment is acceptable.

In no event will CREVIS be responsible or liable for indirect or consequential damages resulting from the use or application of this equipment.

The examples and diagrams in this manual are included solely for illustrative purposes. Because of the many variables and requirements associated with any particular installation, CREVIS cannot assume responsibility or liability for actual use based on the examples and diagrams.

Warning!



- ✓ **If you don't follow the directions, it could cause a personal injury, damage to the equipment or explosion**
- Do not assemble the products and wire with power applied to the system. Else it may cause an electric arc, which can result into unexpected and potentially dangerous action by field devices. Arching is explosion risk in hazardous locations. Be sure that the area is non-hazardous or remove system power appropriately before assembling or wiring the modules.
- Do not touch any terminal blocks or IO modules when system is running. Else it may cause the unit to an electric shock or malfunction.
- Keep away from the strange metallic materials not related to the unit and wiring works should be controlled by the electric expert engineer. Else it may cause the unit to a fire, electric shock or malfunction.

Caution!

- ✓ **If you disobey the instructions, there may be possibility of personal injury, damage to equipment or explosion. Please follow below Instructions.**
- Check the rated voltage and terminal array before wiring. Avoid the circumstances over 55 °C of temperature. Avoid placing it directly in the sunlight.
- Avoid the place under circumstances over 85% of humidity.
- Do not place Modules near by the inflammable material. Else it may cause a fire.
- Do not permit any vibration approaching it directly.
- Go through module specification carefully, ensure inputs, output connections are made with the specifications. Use standard cables for wiring.
- Use Product under pollution degree 2 environment.

1.1. Safety Instruction

1.1.1. Symbols

<p>DANGER</p> 	<p>Identifies information about practices or circumstances that can cause an explosion in a hazardous environment, which may lead to personal injury or death property damage or economic loss.</p>
<p>IMPORTANT</p>	<p>Identifies information that is critical for successful application and understanding of the product.</p>
<p>ATTENTION</p> 	<p>Identifies information about practices or circumstances that can lead to personal injury, property damage, or economic loss. Attentions help you to identify a hazard, avoid a hazard, and recognize the consequences.</p>

1.1.2. Safety Notes

<p>DANGER</p> 	<p>The modules are equipped with electronic components that may be destroyed by electrostatic discharge. When handling the modules, ensure that the environment (persons, workplace and packing) is well grounded. Avoid touching conductive components, e.g. G-BUS Pin.</p>
--	--

1.1.3. Certification

c-UL-us UL Listed Industrial Control Equipment, certified for U.S. and Canada
See UL File E235505

FCC, Reach, RoHS- II, China RoHS

CE Certificate

EN 61000-6-2; Industrial Immunity

EN 61000-6-4; Industrial Emissions

2. Environment Specification

Environment Specification	
Operating Temperature	-20℃~60℃ : 1.0A full load is allowed.
UL Temperature	-20℃~60℃
Storage Temperature	-40℃~85℃
Relative Humidity	5% ~ 90% non-condensing
Mounting	DIN rail
General Specification	
Shock Operating	IEC 60068-2-27
Vibration resistance	Based on IEC 60068-2-6 DNVGL-CG-0039 : Vibration Class B, 4g
Industrial Emissions	EN 61000-6-4/A11 : 2011
Industrial Immunity	EN 61000-6-2 : 2005
Installation Position	Vertical and horizontal installation is available.
Product Certifications	CE, UL, FCC

3. General Description

3.1. GL-9086 Specification

Items	Specification
Communication Interface Specification	
Adapter Type	Slave Node (EtherCAT ID)
Max. Expansion Slot	16 slots
I/O Data Size	Max. Input 256 bytes / Output 256 bytes
Max Length Bus Line	Up to 100m from Ethernet Hub/Switch with twisted CAT5 UTP/STP
Max. Network Node	65,535
Baud Rate	10/100Mbps
Bus Connection	2 x RJ-45
Mac Address / IP Address	Not needed
Indicator	4 Status LEDs 1 Green/Red, Module Status (MOD) 1 Green, Current Communication Status (RUN) 1 Red, Error Status (ERR) 1 Green/Red, Expansion I/O Module Status (IOS)
Module Location	Starter module left side of G-Series system

General Specification	
UL System Power	Supply voltage : 24Vdc nominal, Class 2
System Power	Supply voltage : 24Vdc nominal Supply voltage range : 15~28.8Vdc Protection : Reverse polarity protection
Power Dissipation	40mA typical @ 24Vdc
Current for I/O Module	1.0A @ 5Vdc
Isolation	System power to internal logic : Non-Isolation System power I/O driver : Isolation
UL Field Power	Supply voltage : 24Vdc nominal, Class 2
Field Power	Supply voltage : 24Vdc typical (Max. 28.8Vdc) * Field Power Range is different depending on IO Module series. Refer to IO Module's Specification.
Max. Current Field Power Contact	DC 8A Max
Wiring	I/O Cable Max. 2.0mm ² (AWG 14)
Torque	0.8Nm (7 lb-in)
Weight	76g
Module Size	22mm x 109mm x 70mm
Environment Condition	Refer to '2. Environment Specification'

3.2. GL-9086 Wiring Diagram

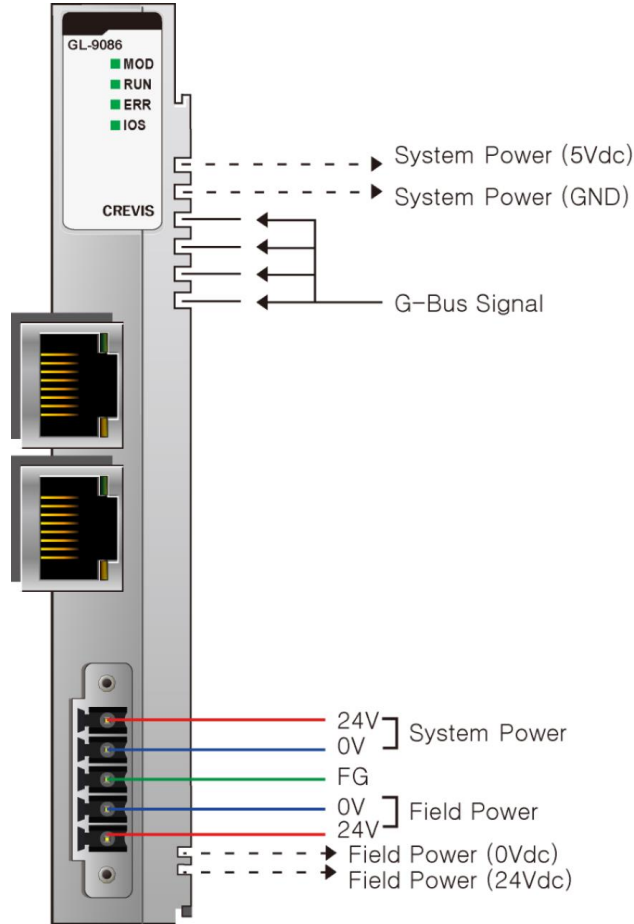

Pin No.	Signal Description
1	System Power, 24V
2	System Power, Ground
3	Frame Ground
4	Field Power, Ground
5	Field Power, 24V

3.3. GL-9086 LED Indicator

3.3.1. LED Indicator

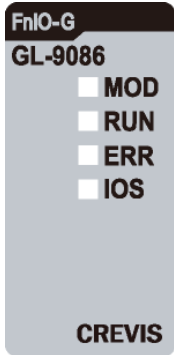

LED No.	LED Function / Description	LED Color
MOD	Module Status	Green/Red
RUN	Current Communication Status	Green
ERR	Error Status	Red
IOS	Expansion I/O Module Status	Green/Red

3.3.2. MOD (Module Status LED)

Status	LED	To indicate
Not Powered	OFF	power is not supplied to the unit.
Normal, Operational	Green	The unit is operating in normal condition.
Device in Standby	Flashing Green	The EEPROM parameter is not initialized yet. Serial Number is zero value (0x00000000)
Minor Fault	Flashing Red	The unit has occurred recoverable fault in self-testing. - EEPROM checksum fault.
Unrecoverable Fault	Red	The unit has occurred unrecoverable fault in self-testing. - Firmware fault

3.3.3. RUN (Current Running Status LED)

Status	LED	To indicate
Init	OFF	State of the EtherCAT State Machine: INIT = Initialization.
Pre-Operation	Blinking	State of the EtherCAT State Machine: PREOP = Pre-Operation.
Safe-Operation	Single Flash	State of the EtherCAT State Machine: SAFEOP = Safe-Operation.
Initialization or Bootstrap	Flashes	State of the EtherCAT State Machine: BOOT = Bootstrap (Update of the coupler firmware)
Operational	ON	State of the EtherCAT State Machine: Operational.

3.3.4. ERR (Error Status LED)

Status	LED	To indicate
No Error	OFF	No Error.
Invalid Configuration	Blinking	Invalid Configuration.

3.3.5. IOS LED(Extension I/O Module Status LED)

Status	LED	To indicate
Not Powered	OFF	Adapter may not be powered.
No Expansion Module	Flashing Red	Adapter has no expansion module.
Internal Bus Connection, Run Exchanging I/O	Green	Exchanging I/O data.
Expansion Configuration Failed	Red	One or more expansion module occurred in fault state. <ul style="list-style-type: none"> - Detected invalid expansion module ID. - Overflowed In/Output Size - Too many expansion module - Initialization failure - Communication failure. - Changed expansion module configuration. - Mismatch vendor code between adapter and expansion module.

3.4. GL-9086 Electrical Interface

3.4.1. RJ-45 Socket

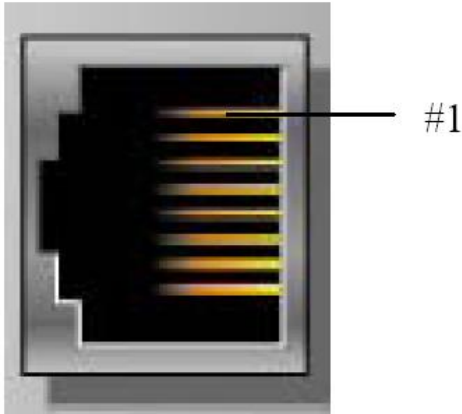

RJ-45	Signal Name	Description
1	TD+	Transmit +
2	TD-	Transmit -
3	RD+	Receive +
4	-	
5	-	
6	RD-	Receive -
7	-	
8	-	
Case	Shield	Shield RJ-45 Socket

3.4.2. DIP Switch

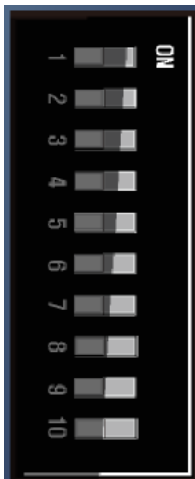

DIP Pole#	Description
1	IdentificationValue DIP bit#0
2	IdentificationValue DIP bit#1
3	IdentificationValue DIP bit#2
4	IdentificationValue DIP bit#3
5	IdentificationValue DIP bit#4
6	IdentificationValue DIP bit#5
7	IdentificationValue DIP bit#6
8	IdentificationValue DIP bit#7
9	Not Used
10	Not Used

3.5. EtherCAT ID Type Setup

3.5.1. Hot Connection On TwinCAT

Hot connection function can be used to remove a node from a preconfigured Configuration or change the location of nodes and flexible. This feature is available only Ethercat ID Type in TwinCAT. The user can use the external Dip Switch settings of the Adapter Identification Value.

For an example of using an external Dip Switch (Refer to 3.4.2.)

Ex) node 1 (Min)



Ex) node 255 (Max)



Hot Connection setting procedure

1. Add the EtherCAT ID Type in TwinCAT.

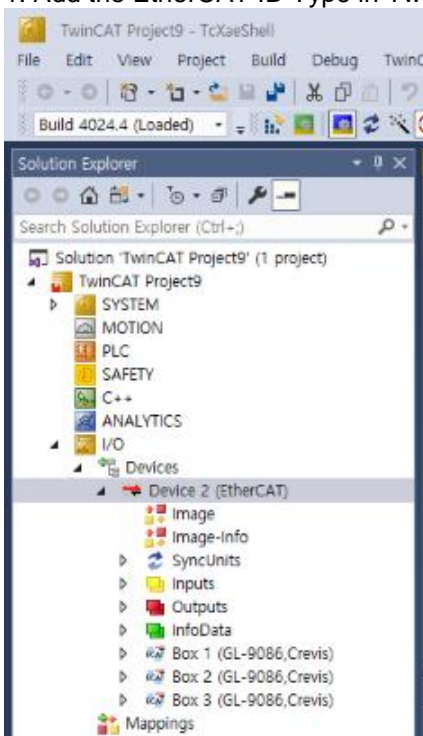

2. Hot Connect Group settings

Set the identification value same as dip-switch.

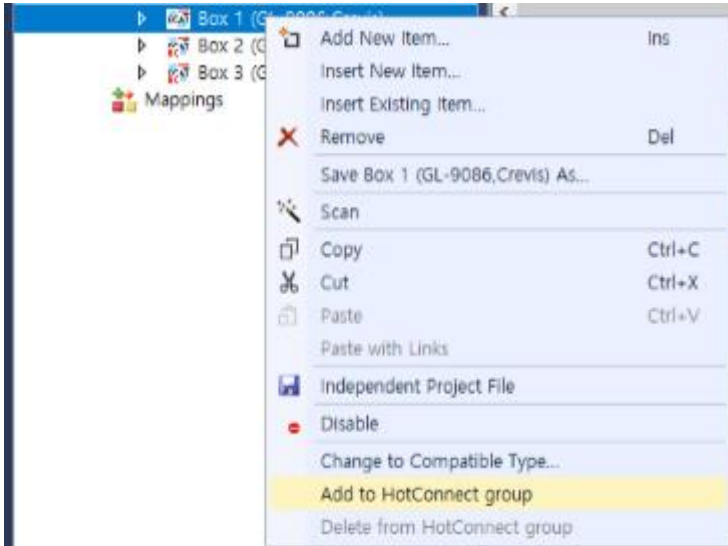

3. Hot connection group set up is completed, run the Reload I/O device(F4).

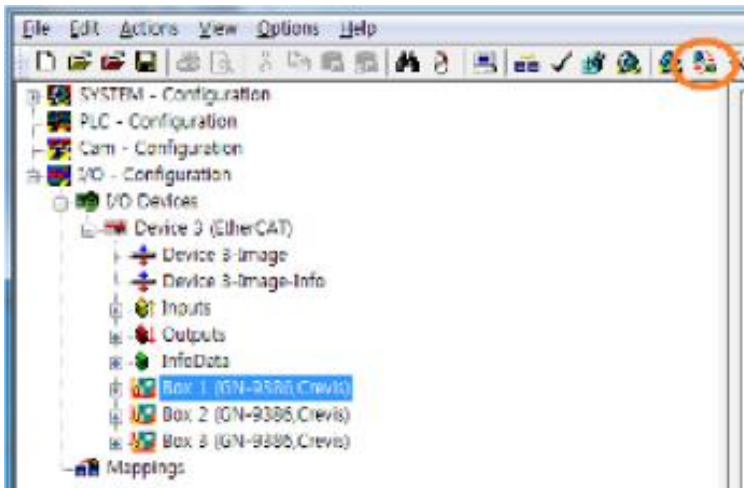

4. Now you can use the Hot connection feature.

Node is not overlapped between products. If there are same nodes, It should be changed.

3.6. I/O Process Image Map

An expansion module may have 3 types of data as I/O data, configuration parameter and memory register. The data exchange between network adapter and expansion modules is done via an I/O process image data by G-Series protocol. The following figure shows the data flow of process image between network adapter and expansion modules.

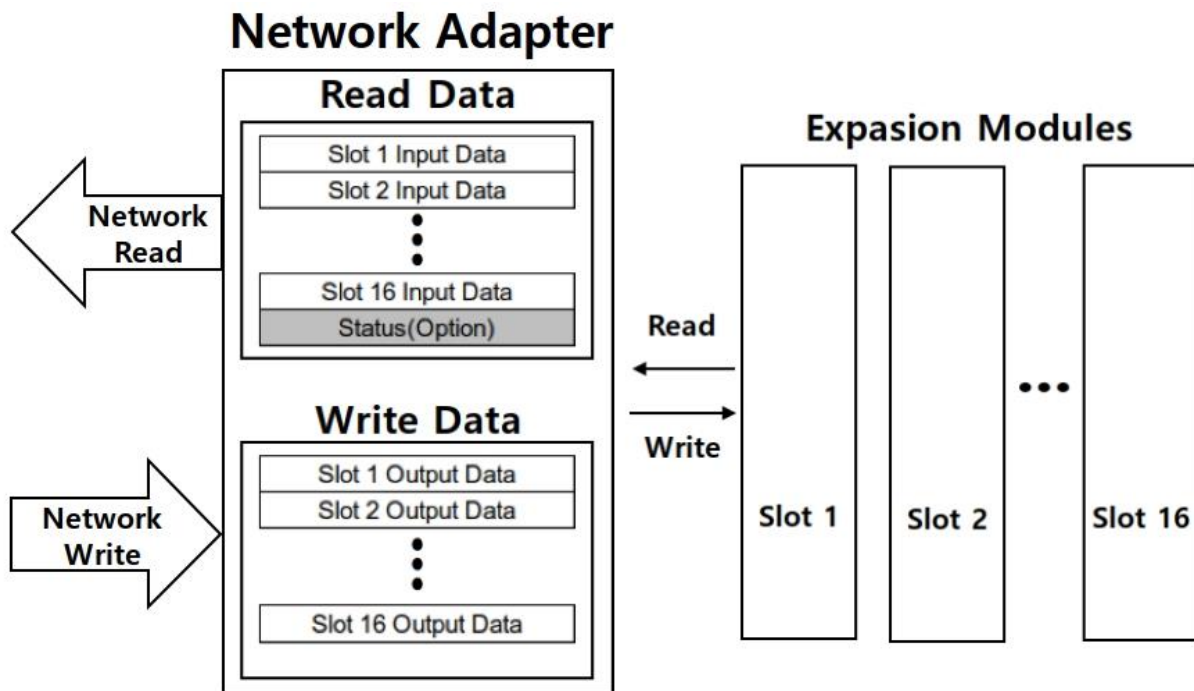

3.6.1. Mapping Data into Image Table

<Discrete Input Module>

• 4 Point Input Module

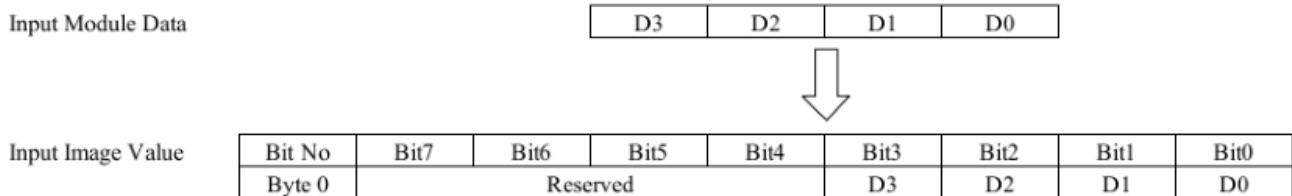

• 8 Point Input Module

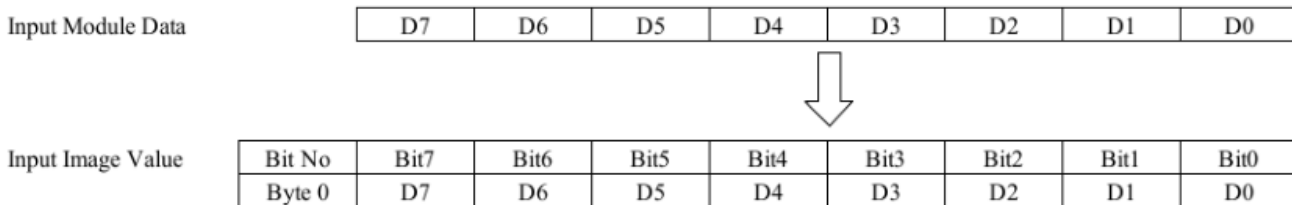

• 16 Point Input Module

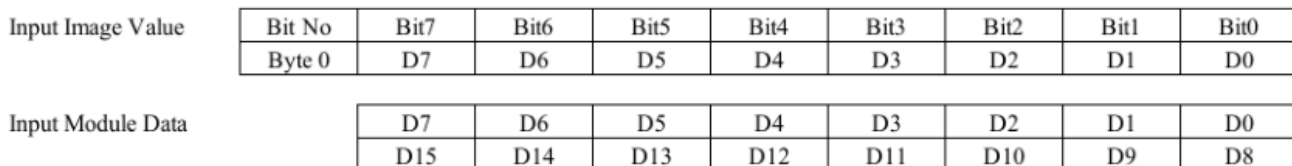

• 32 Point Input Module

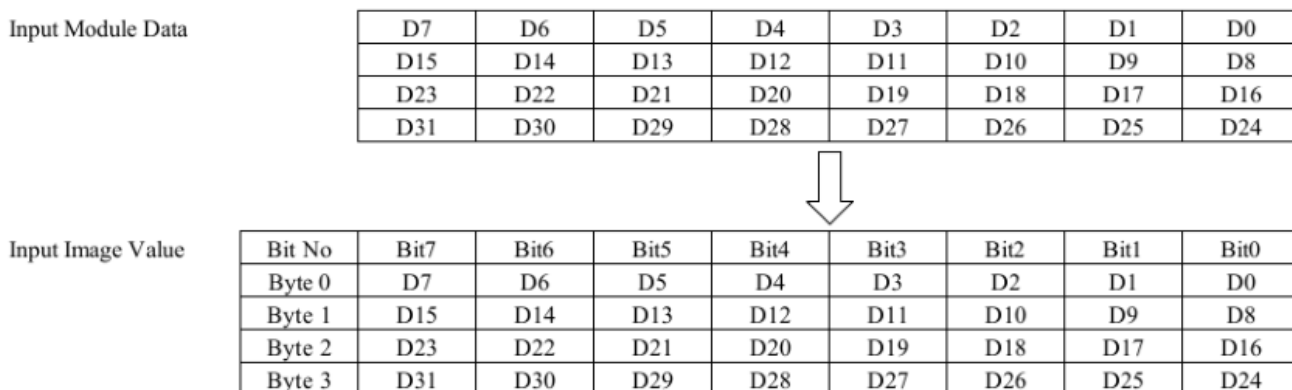

<Discrete Output Module>

• 4 Point Output Module

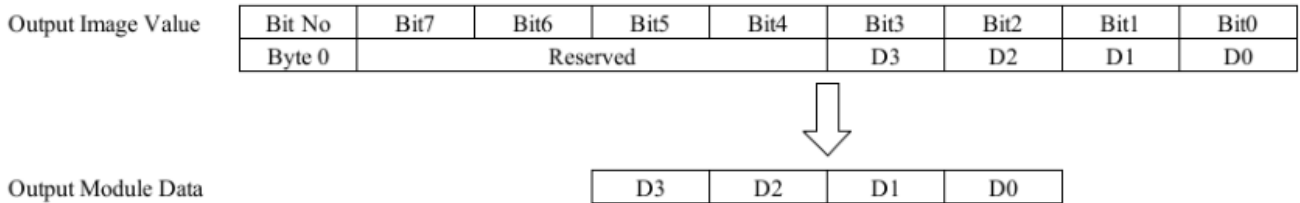

• 8 Point Output Module

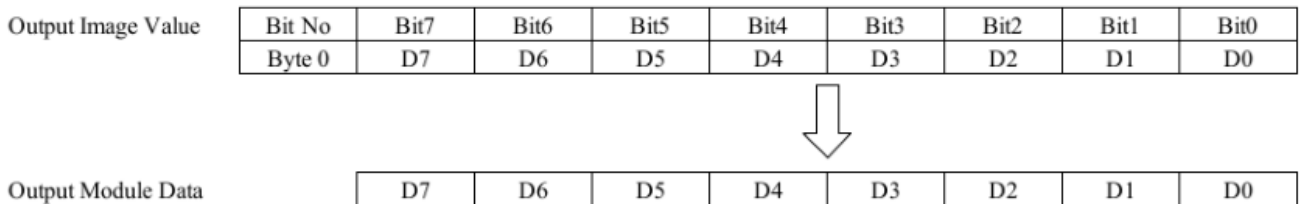

• 16 Point Output Module

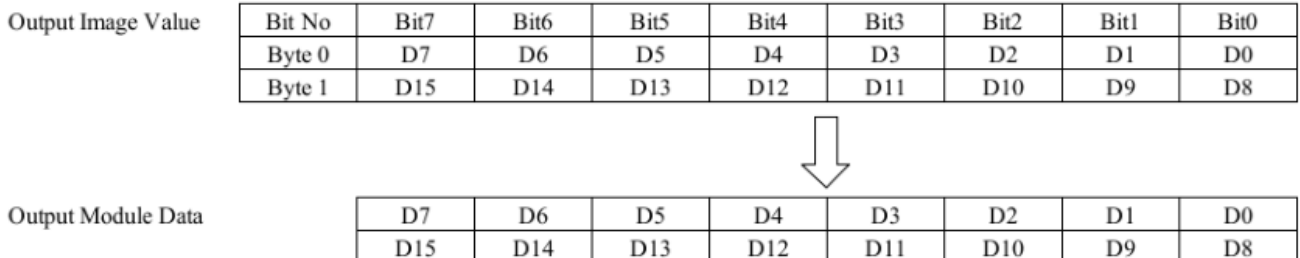

• 32 Point Output Module

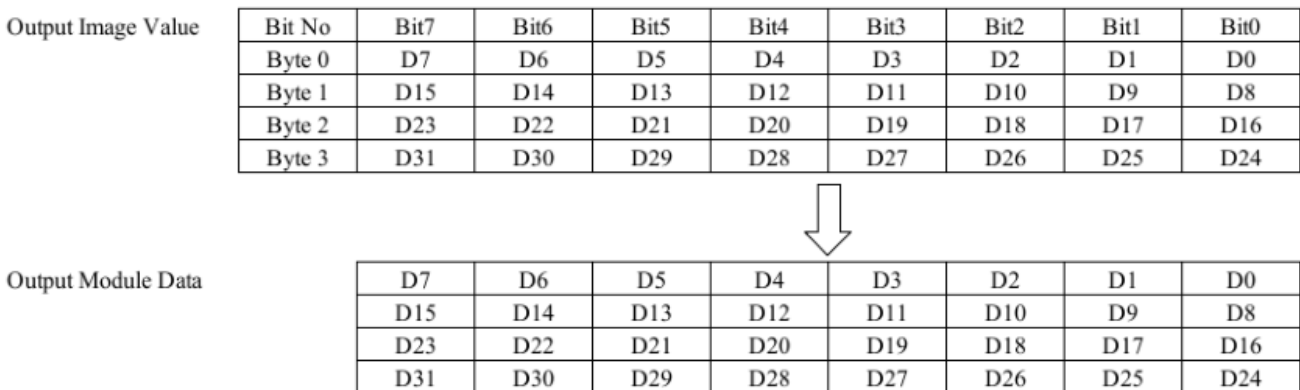

<Analog Input Module>

• 4 Channel Analog Input Module

Input Module Data

Analog Input Ch0
Analog Input Ch1
Analog Input Ch2
Analog Input Ch3



Input Image Value

Bit No	Bit7	Bit6	Bit5	Bit4	Bit3	Bit2	Bit1	Bit0
Byte 0	Analog Input Ch0 low byte							
Byte 1	Analog Input Ch0 high byte							
Byte 2	Analog Input Ch1 low byte							
Byte 3	Analog Input Ch1 high byte							
Byte 4	Analog Input Ch2 low byte							
Byte 5	Analog Input Ch2 high byte							
Byte 6	Analog Input Ch3 low byte							
Byte 7	Analog Input Ch3 high byte							

• 8 Channel Analog Input Module

Input Module Data

Analog Input Ch0
Analog Input Ch1
Analog Input Ch2
Analog Input Ch3
Analog Input Ch4
Analog Input Ch5
Analog Input Ch6
Analog Input Ch7



Input Image Value

Bit No	Bit7	Bit6	Bit5	Bit4	Bit3	Bit2	Bit1	Bit0
Byte 0	Analog Input Ch0 low byte							
Byte 1	Analog Input Ch0 high byte							
Byte 2	Analog Input Ch1 low byte							
Byte 3	Analog Input Ch1 high byte							
Byte 4	Analog Input Ch2 low byte							
Byte 5	Analog Input Ch2 high byte							
Byte 6	Analog Input Ch3 low byte							
Byte 7	Analog Input Ch3 high byte							
Byte 8	Analog Input Ch4 low byte							
Byte 9	Analog Input Ch4 high byte							
Byte 10	Analog Input Ch5 low byte							
Byte 11	Analog Input Ch5 high byte							
Byte 12	Analog Input Ch6 low byte							
Byte 13	Analog Input Ch6 high byte							
Byte 14	Analog Input Ch7 low byte							
Byte 15	Analog Input Ch7 high byte							

<Analog Output Module>

• 4 Channel Analog Output Module

Output Image Value	Bit No	Bit7	Bit6	Bit5	Bit4	Bit3	Bit2	Bit1	Bit0
Byte 0	Analog Output Ch0 low byte								
Byte 1	Analog Output Ch0 high byte								
Byte 2	Analog Output Ch1 low byte								
Byte 3	Analog Output Ch1 high byte								
Byte 4	Analog Output Ch2 low byte								
Byte 5	Analog Output Ch2 high byte								
Byte 6	Analog Output Ch3 low byte								
Byte 7	Analog Output Ch3 high byte								



Output Module Data	Analog Output Ch0
	Analog Output Ch1
	Analog Output Ch2
	Analog Output Ch3

• 8 Channel Analog Output Module

Output Image Value	Bit No	Bit7	Bit6	Bit5	Bit4	Bit3	Bit2	Bit1	Bit0
Byte 0	Analog Output Ch0 low byte								
Byte 1	Analog Output Ch0 high byte								
Byte 2	Analog Output Ch1 low byte								
Byte 3	Analog Output Ch1 high byte								
Byte 4	Analog Output Ch2 low byte								
Byte 5	Analog Output Ch2 high byte								
Byte 6	Analog Output Ch3 low byte								
Byte 7	Analog Output Ch3 high byte								
Byte 8	Analog Output Ch4 low byte								
Byte 9	Analog Output Ch4 high byte								
Byte 10	Analog Output Ch5 low byte								
Byte 11	Analog Output Ch5 high byte								
Byte 12	Analog Output Ch6 low byte								
Byte 13	Analog Output Ch6 high byte								
Byte 14	Analog Output Ch7 low byte								
Byte 15	Analog Output Ch7 high byte								



Output Module Data	Analog Output Ch0
	Analog Output Ch1
	Analog Output Ch2
	Analog Output Ch3
	Analog Output Ch4
	Analog Output Ch5
	Analog Output Ch6
	Analog Output Ch7

3.6.2. Example of Input Process Image (Input Register) Map

Input image data depends on slot position and expansion slot data type. Input process image data is only ordered by expansion slot position.

For example slot configuration

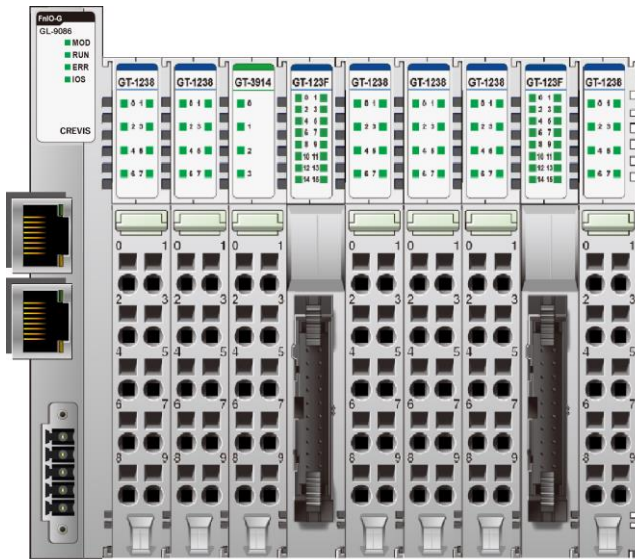

Slot Address	Module Description
#0	EtherCAT Adapter
#1	8-discrete input
#2	8-discrete input
#3	4-analog input
#4	16-discrete input
#5	8-discrete input
#6	8-discrete input
#7	8-discrete input
#8	16-discrete input
#9	8-discrete input

- Input Process Image

Address	b15	b14	b13	b12	b11	b10	b9	b8	b7	b6	b5	b4	b3	b2	b1	b0
0x0001	Discrete Input 8 pts (Slot#2)							Discrete Input 8 pts (Slot#1)								
0x0002	Analog Input Ch0 high byte (Slot#3)							Analog Input Ch0 low byte (Slot#3)								
0x0003	Analog Input Ch1 high byte (Slot#3)							Analog Input Ch1 low byte (Slot#3)								
0x0004	Analog Input Ch2 high byte (Slot#3)							Analog Input Ch2 low byte (Slot#3)								
0x0005	Analog Input Ch3 high byte (Slot#3)							Analog Input Ch3 low byte (Slot#3)								
0x0006	Discrete Input 8 pts (Slot#4)							Discrete Input 8 pts (Slot#4)								
0x0007	Discrete Input 8 pts (Slot#6)							Discrete Input 8 pts (Slot#5)								
0x0008	Discrete Input 8 pts (Slot#8)							Discrete Input 8 pts (Slot#7)								
0x0009	Discrete Input 8 pts (Slot#9)							Discrete Input 8 pts (Slot#8)								

3.6.3. Example of Output Process Image (Output Register) Map

Output image data depends on slot position and expansion slot data type. Output process image data is only ordered by expansion slot position.

For example slot configuration

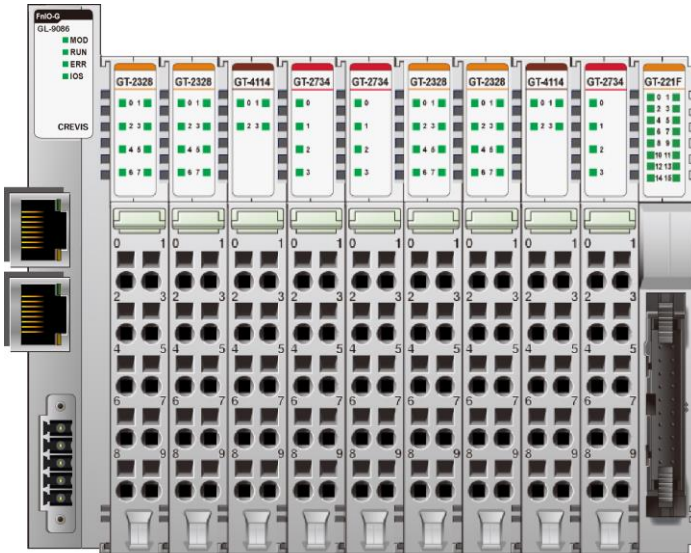

Slot Address	Module Description
#0	EtherCAT Adapter
#1	8-discrete output
#2	8-discrete output
#3	4-analog output
#4	4- relay output
#5	4-relay output
#6	8-discrete output
#7	8-discrete output
#8	4-analog output
#9	4-relay output
#10	16-discrete output

- Output Process Image

Address	b15	b14	b13	b12	b11	b10	b9	b8	b7	b6	b5	b4	b3	b2	b1	b0
0x0800	Discrete Output 8 pts (Slot#2)								Discrete Output 8 pts (Slot#1)							
0x0801	Analog Output Ch0 high byte (Slot#3)								Analog Output Ch0 low byte (Slot#3)							
0x0802	Analog Output Ch1 high byte (Slot#3)								Analog Output Ch1 low byte (Slot#3)							
0x0803	Analog Output Ch2 high byte (Slot#3)								Analog Output Ch2 low byte (Slot#3)							
0x0804	Analog Output Ch3 high byte (Slot#3)								Analog Output Ch3 low byte (Slot#3)							
0x0805	Empty, Don't Care				Discrete Out 4 pts (Slot#5)				Empty, Don't Care				Discrete Out 4 pts (Slot#4)			
0x0806	Discrete Output low 8 pts (Slot#7)								Discrete Output low 8 pts (Slot#6)							
0x0807	Analog Output Ch0 high byte (Slot#8)								Analog Output Ch0 low byte (Slot#8)							
0x0808	Analog Output Ch1 high byte (Slot#8)								Analog Output Ch1 low byte (Slot#8)							
0x0809	Analog Output Ch2 high byte (Slot#8)								Analog Output Ch2 low byte (Slot#8)							
0x080A	Analog Output Ch3 high byte (Slot#8)								Analog Output Ch3 low byte (Slot#8)							
0x080B	Discrete Output low 8 pts (Slot#10)								Empty, Don't Care				Discrete Out 4 pts (Slot#9)			
0x080C	Empty, Don't Care								Discrete Output high 8 pts (Slot#10)							

4. Dimension

4.1. GL-9086

(mm)

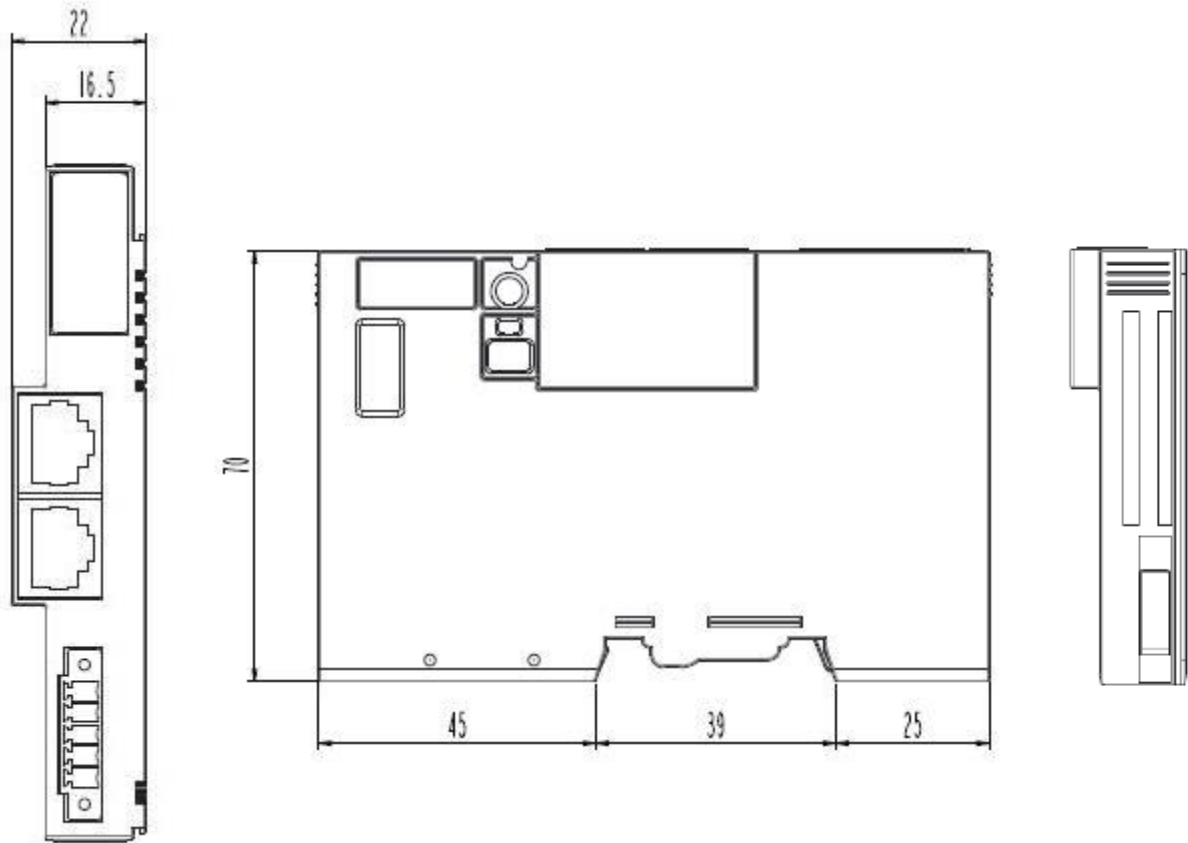

5. EtherCAT Basics

The EtherCAT protocol uses an officially assigned EtherType inside the Ethernet Frame. The use of this EtherType allows transport of control data directly within the Ethernet frame without redefining the standard Ethernet frame. The frame may consist of several sub-telegrams, each serving a particular memory area of the logical process images that can be up to 4 gigabytes in size. Addressing of the Ethernet terminals can be in any order because the data sequence is independent of the physical order. Broadcast, Multi-cast and communication between slaves are possible.

5.1. EtherCAT State Machine

The state of the EtherCAT slave is controlled via the EtherCAT State Machine (ESM). Depending upon the state, different functions are accessible or executable in the EtherCAT slave. Specific commands must be sent by the EtherCAT master to the device in each state, particularly during the bootup of the slave.

A distinction is made between the following states:

- Init
- Pre-Operational
- Safe-Operational and
- Operational
- Bootstrap

The regular state of each EtherCAT slave after bootup is the OP state.

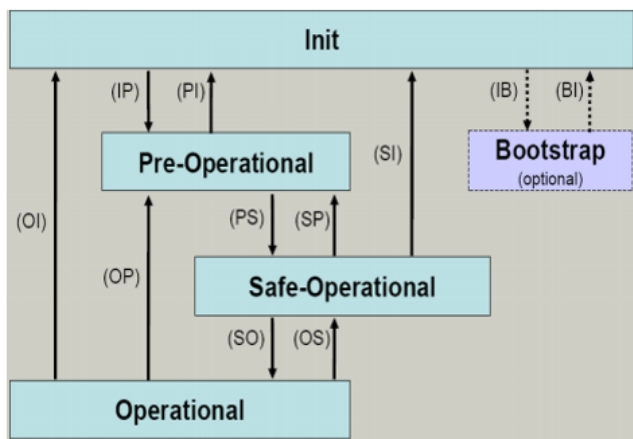

Init

After switch-on the EtherCAT slave in the Init state. No mailbox or process data communication is possible. The EtherCAT master initializes sync manager channels 0 and 1 for mailbox communication.

Pre-Operational (Pre-Op)

During the transition between Init and Pre-Op the EtherCAT slave checks whether the mailbox was initialized correctly.

In Pre-Op state mailbox communication is possible, but not process data communication. The EtherCAT master initializes the sync manager channels for process data (from sync manager channel 2), the FMMU channels and, if the slave supports configurable mapping, PDO mapping or the sync manager PDO assignment. In this state the settings for the process data transfer and perhaps terminal-specific parameters that may differ from the default settings are also transferred.

Safe-Operational (Safe-Op)

During transition between Pre-Op and Safe-Op the EtherCAT slave checks whether the sync manager channels for process data communication and, if required, the distributed clocks settings are correct. Before it acknowledges the change of state, the EtherCAT slave copies current input data into the associated DP-RAM areas of the EtherCAT slave controller (ECSC).

In Safe-Op state mailbox and process data communication is possible, although the slave keeps its outputs in a safe state, while the input data are updated cyclically.

Operational (Op)

Before the EtherCAT master switches the EtherCAT slave from Safe-Op to Op it must transfer valid output data.

In the Op state the slave copies the output data of the masters to its outputs. Process data and mailbox communication is possible.

Bootstrap

In the Boot state the slave firmware can be updated. The Boot state can only be reached via the Init state.

In the Boot state mailbox communication via the file access over EtherCAT (FoE) protocol is possible, but no other mailbox communication and no process data communication.

5.2. CoE Interface

5.2.1. Parameter management in the EtherCAT system

The CiA organization (CAN in Automation) pursues among other things the goal of creating order and exchange ability between devices of the same type by the standardization of device descriptions. For this purpose so-called profiles are defined, which conclusively describe the changeable and unchangeable parameters of a device. Such a parameter encompasses at least the following characteristics:

- Index number – for the unambiguous identification of all parameters. The index number is divided into a main index and a subindex in order to mark and arrange associated parameters.
 - Main index
 - Subindex, offset by a colon ':'
- Official name – in the form of an understandable, self-descriptive text
- Specification of changeability, e.g. whether it can only be read or can also be written
- A value – depending upon the parameter the value can be a text, a number or another parameter index.

Index Range

The relevant ranges for EtherCAT fieldbus users are:

- x1000** : This is where fixed identity information for the device is stored, including name, manufacturer, serial number etc., plus information about the current and available process data configurations.
- x8000** : This is where the operational and functional parameters for all channels are stored, such as filter settings or output frequency.

Other important ranges are:

- x4000** : In some EtherCAT devices the channel parameters are stored here (as an alternative to the x8000 range).
- x6000** : Input PDOs ("input" from the perspective of the EtherCAT master)
- x7000** : Output PDOs ("output" from the perspective of the EtherCAT master)

5.2.2. Communication Objects

Index	Sub-index	Name	Flags	Default value
1000		Device type	RO	0x00001389
1001		Gbus Status	RO	Normal Operation : 0x00 **
1002		Master Fault Action	RW	0x00
1008		Device name	RO	GL-9086(Crevis)
1009		Hardware version	RO	GL-9086.v1
100A		Software version	RO	1.000
1018		Identity	RO	0x05
	01	Vendor ID (Crevis: 029D)	RO	0x0000029D
	02	Product code	RO	0x474C9086
	03	Revision	RO	0x0001000
	04*	Serial number	RO	0xFFFFFFFF
	05	Release date	RO	0x20200325
10F1		Error Settings	RO	0x02
	01	Local Error Reaction	RO	0x00000000
	02	Sync Error Counter Limit	RO	0x00000004
1601*		Slot#x, GT--xxxx,RXPDO	RO	0xnn
	01	SubIndex 001	RO	0x7010:01, 8

	nn	SubIndex nnn	RO	0x7010:nn, 8
1A01*		Slot#x, GT-xxxx, TXPDO	RO	0xnn
	01	SubIndex 001	RO	0x6010:01, 8

	nn	SubIndex nnn	RO	0x6010:nn, 8
1C00		Sync manager type	RO	0x04
	01	SubIndex 001	RO	0x01
	02	SubIndex 002	RO	0x02
	03	SubIndex 003	RO	0x03
	04	SubIndex 004	RO	0x04
1C12		RxPDO assign	RO	0x01
	01	SubIndex 001	RO	0x1601
1C13		TxPDO assign	RO	0x02
	01	SubIndex 001	RO	0x1A01
	02	SubIndex 002	RO	0x1A02

7010*	GT-xxxx		RO	0xnn
	01	Byte#0	RW P	0x00

	nn	Byte#nnn	RW P	0x00
8000	GL-9086(Parameter)		RO	
	01	Byte#0	RW	
	02	Byte#1	RW	
	03	Byte#2	RW	
	04	Byte#3	RW	
8nn0*	GT-xxxx(Parameter)		RO	
	01	Byte#0	RW	

	nn	Byte#nnn	RW	
F000	Module device profile		RO	
	01	Module index distance	RO	
	02	Maximum number of modules	RO	
F010*	Module List		RO	
	01	Subindex 001 (GL-9086)	RO	0x00009086

	16	Subindex 016	RO	0x0000xxxx
F050	Detected Module Ident List		RO	
	01...	SubIndex 001	RO	

*This value can be changed depending on the configuration of expansion modules

** G-BUS Status

- Normal Operation : 0x00
- Communication Fault : 0x02
- Configuration Failed : 0x03
- No Expansion Module : 0x04
- Vendor Error : 0x07
- Not expected slot : 0x08
- CRC Error : 0x09

6. TROUBLE SHOOTING

How to diagnose by LED indicator

LED Status	Cause	Action
All LED turns off	- No power	- Check main power Cable
MOD LED is red	- Occurrence critical error in firmware	- Contact Sales team and send module for repair.
ERROR LED blinking red	- Invalid Configuration	- Check I/O size configuration
IOS LED turns off	- Device may not be powered.	- Check main power Cable
IOS LED flashes red	- Adapter has no expansion module	- Add one or more expansion modules.
IOS LED is red	<p>One or more expansion module occurred in fault state.</p> <ul style="list-style-type: none"> - Detected invalid expansion module ID. - Overflowed Input/Output Size - Too many expansion module - Initialization failure - Communication failure. - Changed expansion module configuration. - Mismatch vendor code between adapter and expansion module. 	<ul style="list-style-type: none"> - Use expansion slot up to 63. - Compose that IO total size is not excess. - Check status of expansion IO connection. - Check the vendor code of module.

How to diagnose when device couldn't communicate network

Inspection of wrong or omission cable connection

- Check status of cable connection for each node.
- Check that all color matches between connector and cable.
- Check wire omission.

Terminator resistor

- If terminator resistor is not installed, install terminator resistor
- Check location of terminator resistor

Configuration of Node address

- Check duplication node address.

Configuration of Master

- Check configuration of master
- Check whether to do download or don't
- Check composition is right as below Configuration of communication baud rate I/O size
Configuration of each node

Ground and environment

- Check ground is contacted
- Check environment factor (temperature, humidity, etc.) is in less than regular limit

APPENDIX A

A.1. Product List

No.	GT-Number	Description	ID(hex)
Digital Input Module			
1	GT-1238	8 Points, Universal, 24Vdc, 10RTB	1238
2	GT-123F	16 Points, Universal, 24Vdc, 20P connector	123F
3	GT-12DF	16 Points, Universal, 24Vdc, 18RTB	12DF
4	GT-12FA	32 Points, Universal, 24Vdc, 40P connector	12FA
5	GT-1428	8 Sink Input / 8 Source Output with Diagnostic, 24Vdc	1428
6	GT-1804	4 Points, 120Vac, 10RTB	1804
7	GT-1904	4 Points, 240Vac, 10RTB	1904
Digital Output Module			
8	GT-2318	8 Points, Sink, 24Vdc/0.5A, 10RTB	2318
9	GT-2328	8 Points, Source, 24Vdc/0.5A, 10RTB	2328
10	GT-221F	16 Points, Sink, 24Vdc/0.3A, 20P connector	221F
11	GT-222F	16 Points, Source, 24Vdc/0.3A, 20P connector	222F
12	GT-225F	16 Points, Sink, 24Vdc/0.3A, 18RTB	225F
13	GT-226F	16 Points, Source, 24Vdc/0.3A, 18RTB	226F
14	GT-22BA	32 Points, Sink, 24Vdc/0.3A, 40P connector	22BA
15	GT-22CA	32 Points, Source, 24Vdc/0.3A, 40P connector	22CA
16	GT-2418	8 Channels Sink Output with Diagnostics	2418
17	GT-2428	8 Channels Source Output with Diagnostics	2428
18	GT-2618	8 Points, Sink, 24Vdc/2A, 10RTB	2618
19	GT-2628	8 Points, Source, 24Vdc/2A, 10RTB	2628
20	GT-2734	4 Points, MOS Relay, 240Vdc/ac, 0.5A, 10RTB	2734
21	GT-2738	8 Points, MOS Relay Output Terminal, 240Vdc, 0.5A	2738
22	GT-2744	4 Points, Relay, 24Vdc/2A, 240Vac/2A, 10RTB	2744
23	GT-2764	4 Points, MOS Relay, 24Vdc/ac, 2A, 10RTB	2764
24	GT-2768	8 Points, Relay Output Terminal, 24Vdc/ac, 2A	2768
25	GT-2784	4 Points, MOS Relay, 110Vdc/ac, 1A, 10RTB	2784
26	GT-2788	8 Points, Relay Output Terminal, 110Vdc/ac, 1A	2788
Analog Input Module			
27	GT-3002	2ch load cell input unit, strain gauge	3002
28	GT-3114	4 Channels, 0~20, 4~20mA, 12bits, 10RTB	3114
29	GT-3154	4 Channels, 0~20, 4~20mA, 16bits, 10RTB	3154
30	GT-3118	8 Channels, 0~20, 4~20mA, 12bits, 10RTB	3118
31	GT-3158	8 Channels, 0~20, 4~20mA, 16bits, 10RTB	3158
32	GT-311F	16 Channels, 0~20, 4~20mA, 12bits, 20P connector	311F
33	GT-315F	16 Channels, 0~20, 4~20mA, 16bits, 20P connector	315F
34	GT-317F	16 Channels, 0~20, 4~20mA, 12bits, 18RTB	317F
35	GT-319F	16 Channels, 0~20, 4~20mA, 16bits, 18RTB	319F
36	GT-3424	4 Channels, 0~10, 0~5, 1~5Vdc, 12bits, 10RTB	3424
37	GT-3464	4 Channels, 0~10, 0~5, 1~5Vdc, 16bits, 10RTB	3464
38	GT-3428	8 Channels, 0~10, 0~5, 1~5Vdc, 12bits, 10RTB	3428

39	GT-3468	8 Channels, 0~10, 0~5, 1~5Vdc, 16bits, 10RTB	3468
40	GT-342F	16 Channels, 0~10, 0~5, 1~5Vdc, 12bits, 20P connector	342F
41	GT-346F	16 Channels, 0~10, 0~5, 1~5Vdc, 16bits, 20P connector	346F
42	GT-347F	16 Channels, 0~10, 0~5, 1~5Vdc, 12bits, 18RTB	347F
43	GT-349F	16 Channels, 0~10, 0~5, 1~5Vdc, 16bits, 18RTB	349F
44	GT-3704	4 Channels, RTD, 10RTB	3704
45	GT-3708	8 Channels, RTD, 20P connector	3708
46	GT-3804	4 Channels, Thermocouple, 10RTB	3804
47	GT-3808	8 Channels, Thermocouple, 20P connector	3808
48	GT-3714	4 Channels, TEMP. Controller, RTD Input, SSR Output	3714
49	GT-3734	4 Channels, TEMP. Controller, RTD Input, Current Output	3734
50	GT-3814	4 Channels, TEMP. Controller, TC Input, SSR Output	3814
51	GT-3834	4 Channels, TEMP. Controller, TC Input, Current Output	3834
52	GT-3901	AC Measurement	3901
53	GT-3914	4 Channels, Differential, 0~20, 4~20, +/-20mA, 12Bits, 10RTB	3914
54	GT-3934	4 Channels, Differential, 0~20, 4~20, +/-20mA, 16Bits, 10RTB	3934
55	GT-3918	8 Channels, Differential, 0~20, 4~20, +/-20mA, 12Bits, 18RTB	3918
56	GT-3938	8 Channels, Differential, 0~20, 4~20, +/-20mA, 16Bits, 18RTB	3938
57	GT-3924	4 Channels, Differential, 0~5, 0~10, +/-5, +/-10Vdc, 12Bits, 10RTB	3924
58	GT-3944	4 Channels, Differential, 0~5, 0~10, +/-5, +/-10Vdc, 16Bits, 10RTB	3944
59	GT-3928	8 Channels, Differential, 0~5, 0~10, +/-5, +/-10Vdc, 12Bits, 18RTB	3928
60	GT-3948	8 Channels, Differential, 0~5, 0~10, +/-5, +/-10Vdc, 16Bits, 18RTB	3948
Analog Output Module			
61	GT-4114	4CH, 0~20mA, 12Bits, 10RTB	4114
62	GT-4154	4CH, 0~20mA, 16Bits, 10RTB	4154
63	GT-4118	8CH, 0~20mA, 12Bits, 10RTB	4118
64	GT-4158	8CH, 0~20mA, 16Bits, 10RTB	4158
65	GT-4214	4 Channels, Current Output, 4~20mA, 12bits	4214
66	GT-4254	4 Channels, Current Output, 4~20mA, 16bits	4254
67	GT-4218	8 CHANNELS CURRENT OUTPUT, 4~20mA, 12BIT	4218
68	GT-4258	8 CHANNELS CURRENT OUTPUT, 4~20mA, 16BIT	4258
69	GT-4424	4CH, 0~10Vdc, 12Bits, 10RTB	4424
70	GT-4464	4CH, 0~10Vdc, 16Bits, 10RTB	4464
71	GT-4428	8CH, 0~10Vdc, 12Bits, 10RTB	4428
72	GT-4468	8CH, 0~10Vdc, 16Bits, 10RTB	4468
73	GT-442F	16CH, 0~10Vdc, 12Bits, 20P Connector	442F
74	GT-446F	6CH, 0~10Vdc, 16Bits, 20P Connector	446F
75	GT-447F	16CH, 0~10Vdc, 12Bits, 18RTB	447F
76	GT-449F	16CH, 0~10Vdc, 16Bits, 18RTB	449F
77	GT-4524	AO 4 CHs, ±10Vdc, 12Bits, 10RTB	4524
78	GT-4564	AO 4 CHs, ±10Vdc, 16Bits, 10RTB	4564
Special Module			
79	GT-5102	2CH, Encoder, Input, 5Vdc, 10RTB	5102
80	GT-5112	High Speed Counter, 2CHs, 24Vdc, Encoder Input, 10RTB	5112
81	GT-5114	High Speed Counter, 4CHs, 24Vdc, Encoder Input, 10RTB	5114
82	GT-5211	1CH, RS 232, RTS/CTS, Full Duplex Type, 10RTB	5211

83	GT-5212	2CH, RS 232, Full Duplex Type, 10RTB	5212
84	GT-5221	1CH, RS 485, Full Duplex Type, 10RTB	5221
85	GT-5231	1CH, RS 485, Half Full Duplex Type, 10RTB	5231
86	GT-5232	2CH, RS 485, Half Full Duplex Type, 10RTB	5232
87	GT-5352	2CH, Synchronous Serial Interface Input, 10RTB	5352
88	GT-5442	PWM Output, 2CHs, 0.5A/24Vdc, Source, 18RTB	5442
89	GT-5444	PWM Output, 4CHs, 0.5A/24Vdc, Source, 18RTB	5444
90	GT-5642	Pulse Output, 2CHs, 0.5A/24Vdc, Source, 18RTB	5642
91	GT-5652	Pulse Output, 2CHs, RS422 (Differential), 18RTB	5652
92	GT-5521	1CH, Stepper Module	5521
Power Module			
93	GT-7408	Shield Module	7408
94	GT-7508	Common for 0Vdc	7508
95	GT-7511	Power Expansion, In 24Vdc, Out 1A/5Vdc	7511
96	GT-7518	Common for 24Vdc	7518
97	GT-7588	Common for 0Vdc, 24Vdc	7588
98	GT-7641	Field Power, 5/24/48 Vdc, 110/220 Vac	7641
99	GT-7151	Noise Filter Module, 18RTB, None ID Type	7151
100	GT-7851	Noise Filter Module, 18RTB, ID Type	7851

A.2. Glossary

- System Power : The power for starting up CPU.
- Field Power : The power for input and output line.
- Terminator Resistor : Resistor for prevention reflected wave.
- EDS : Electronic Data Sheet.
- Sink : The method of in/output power supply if a device has no power source.
- Source : The method of in/output power supply if a device has the power source.



IP SYSTEMES

8 rue du Colonel Chambonnet – BP67

69672 BRON Cedex

Tel. : 04 72 14 18 00

Fax : 04 72 14 18 01

www.ip-systemes.com – info@ip-systemes.fr